

飛航事故調查報告 第二冊

ASC-AOR-05-02-001

中華民國 91 年 5 月 25 日

中華航空公司 CI611 班機

BOEING 747-200 型機

國籍標誌及登記號碼 B-18255

於澎湖縣馬公市東北 23 哩處之台灣海峽

上空空中解體

行政院飛航安全委員會
AVIATION SAFETY COUNCIL
中華民國九十四年六月

本頁空白

目 錄

附錄 1	飛航組員基本資料.....	3
附錄 2	波音 747-200 機身站位圖.....	5
附錄 3	華航工程建議 ERE (747) - AS062 文件.....	17
附錄 4	波音編號 BFSTPE CI-TPE-80-22TE 電報.....	19
附錄 5	波音 B-H200-17660-ASI 信函.....	21
附錄 6	華航 B-1866 (B-18255) 航空器經歷簿民國 69 年紀錄.....	25
附錄 7	華航 B-1866 (B-18255) 民國 69 年機尾觸地事件相關維修紀錄.....	29
附錄 8	天氣資料.....	31
附錄 9	CI611 座艙語音紀錄器抄件.....	33
附錄 10	CI611 座艙語音紀錄器聲紋.....	49
附錄 11	CI611 飛航資料紀錄器參數表.....	51
附錄 12	CI611 飛航資料紀錄器參數圖表.....	53
附錄 13	飛安會 CI611 殘骸資料庫.....	61
附錄 14	系統組件測試報告.....	95
附錄 15	中科院材料測試報告—中文版.....	173
附錄 16	波音 BMT 實驗室測試報告.....	203
附錄 17	第 640 號殘骸之複驗報告.....	313
附錄 18	裂痕傳遞方向判定方法.....	319
附錄 19	照明建議規範.....	323

此頁空白

附錄一 飛航組員基本資料

ITEM	CM-1	CM-2	CM-3
Gender	Male	Male	Male
Age	51	52	54
Date Joined CAL	Mar-01-1991	Feb-01-1990	Mar-01-1977
License Type	ATPL 11136	ATPL 11030	FEL 90203
Type Rating	B747-200 CAPT	B747-200 F/O	B747-200 FE
Expire date	Aug-31-2002	Jul-16-2002	Jul-22-2002
Medical Class	Class 1	Class 1	Class 2
Expire date	Jun-30-2002	Oct-31-2002	Sep-30-2002
Last Check Date	Aug-13-2001	Mar-17-2002	May-05-2002
Total Flight Time (H: M)	10,148:31	10,173:18	19,117:52
Flight Time (H: M) In Last 12 Months	647:16	753:16	809:29
Flight Time (H: M) In Last 90 Days	256:44	225:19	250:42
Flight Time (H: M) In Last 30 Days	69:11	67:16	68:30
Flight Time (H: M) In Last 7 Days	25:34	9:59	3:32
Flight Time (H: M) On B747-200	4,732:20	5,831:17	15,397:36
Flight Time On the Day Before the Accident Flight	0 hrs	0 hrs	0 hrs
Rest Period Before the Accident	(Over 24 hrs)	(Over 24 hrs)	(Over 24 hrs)

此頁空白

附錄 2 波音 747-200 機身站位圖

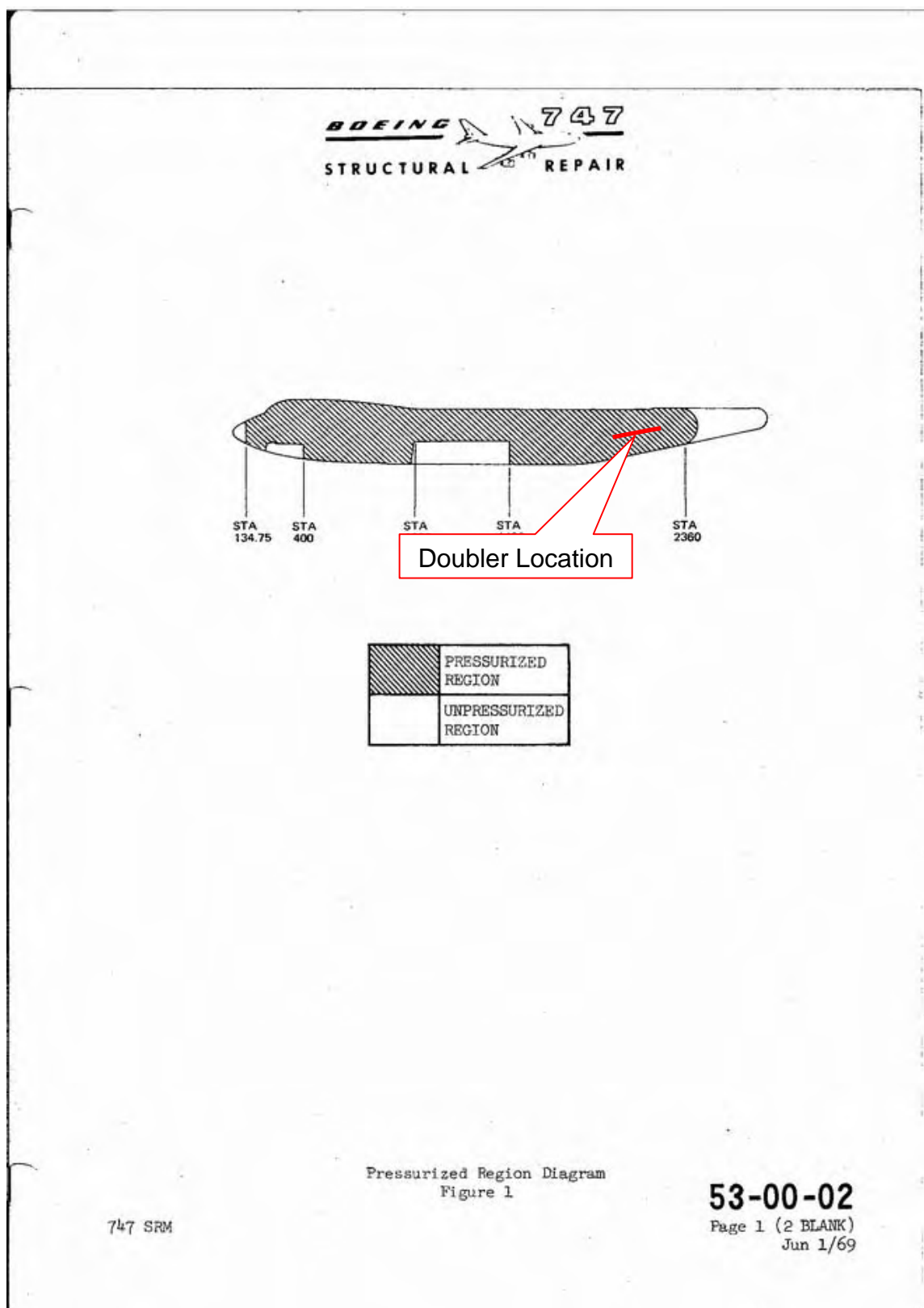

BOEING
747 
STRUCTURAL REPAIR

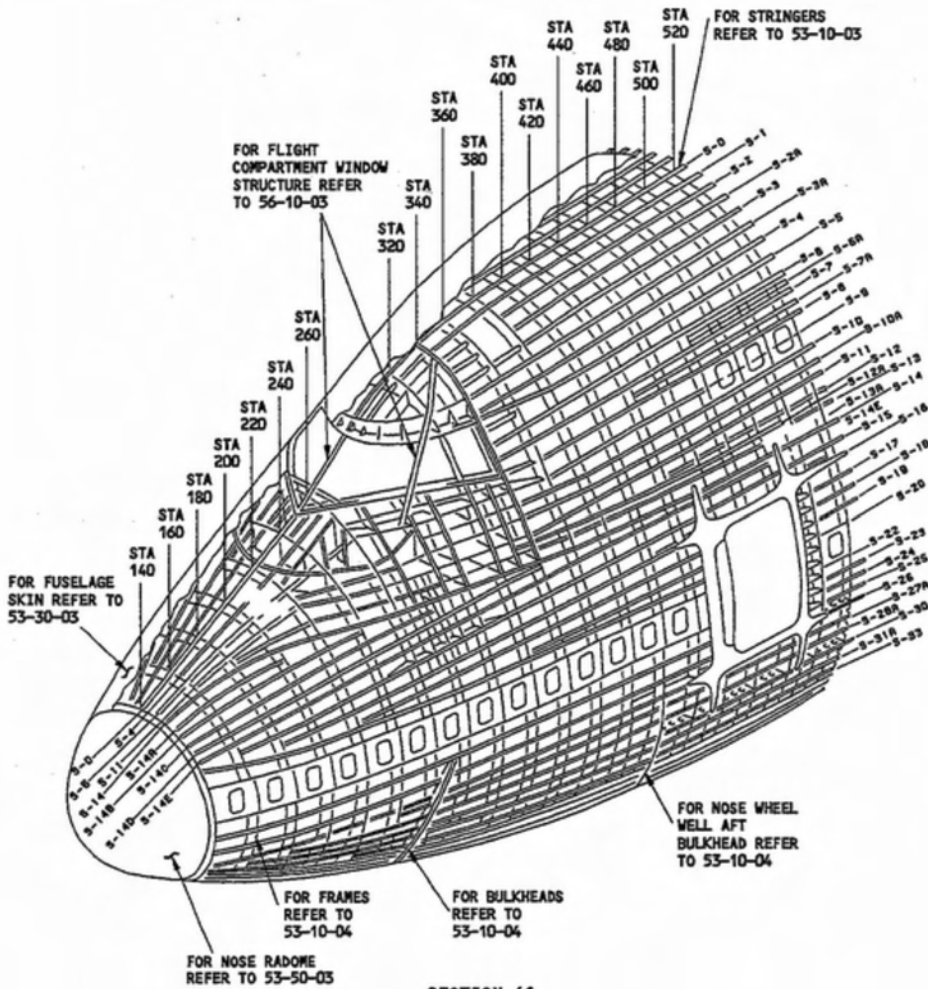

SECTION 41
AIRPLANES WITHOUT NOSE CARGO DOOR
DETAIL I

Fuselage Structure Repair Index
Figure 1 (Sheet 1)

611156

747 SRM

53-10-00

Page 1
Mar 15/94

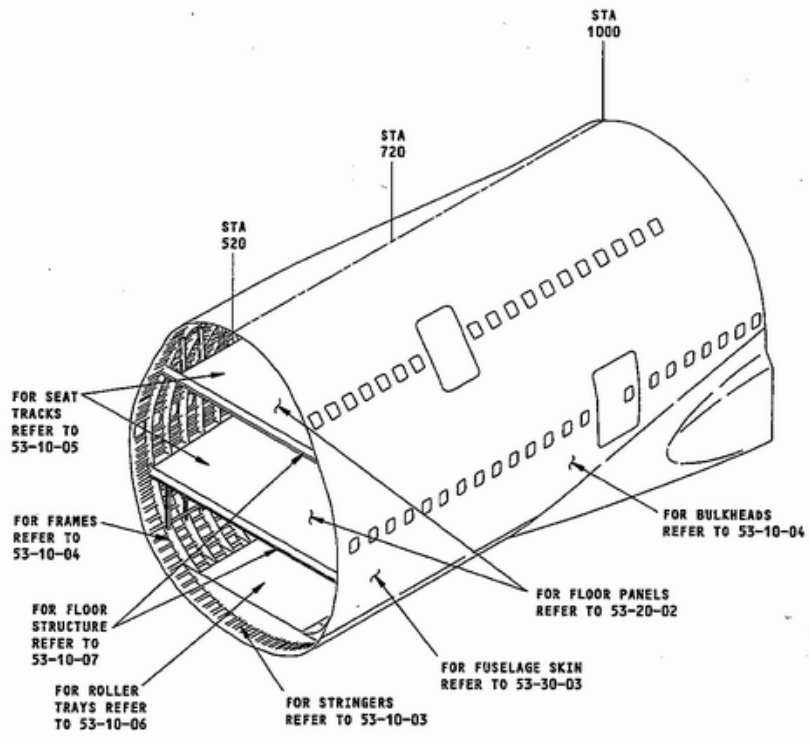

SECTION 42
DETAIL III

Fuselage Structure Repair Index
Figure 1 (Sheet 3)

611160

747 SRM

53-10-00
Page 3
Mar 15/94

BOEING
747
STRUCTURAL REPAIR

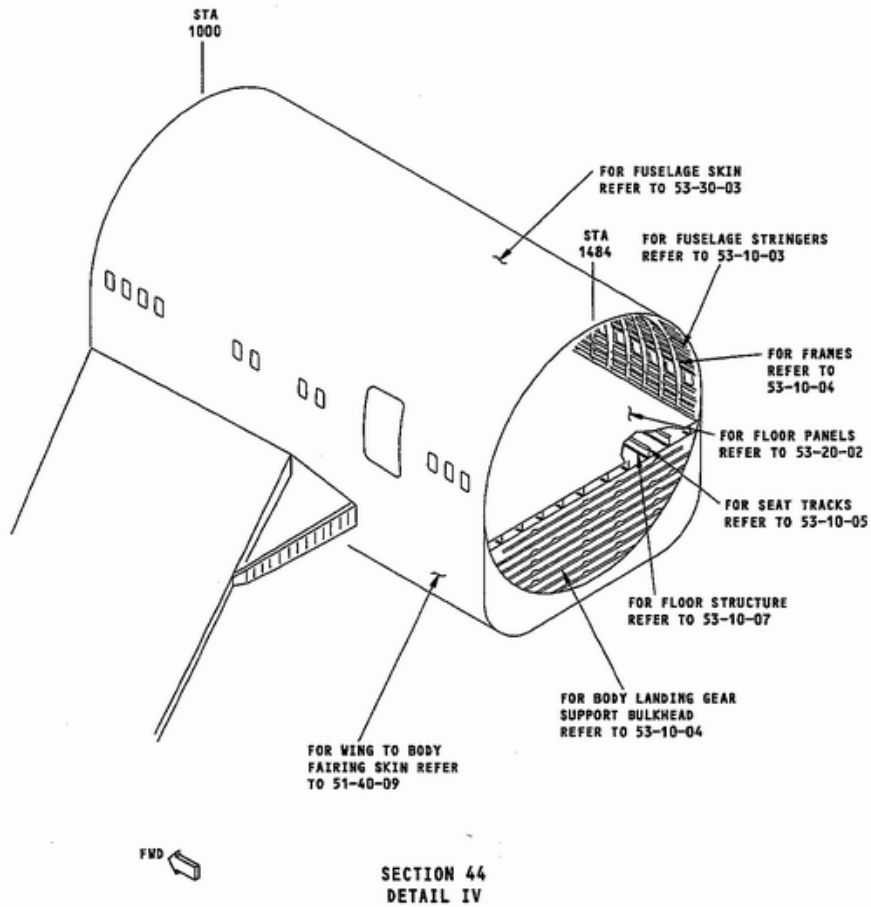

Fuselage Structure Repair Index
Figure 1 (Sheet 4)

611162

53-10-00
Page 4
Mar 15/94

747 SRM

BOEING
747 
STRUCTURAL REPAIR

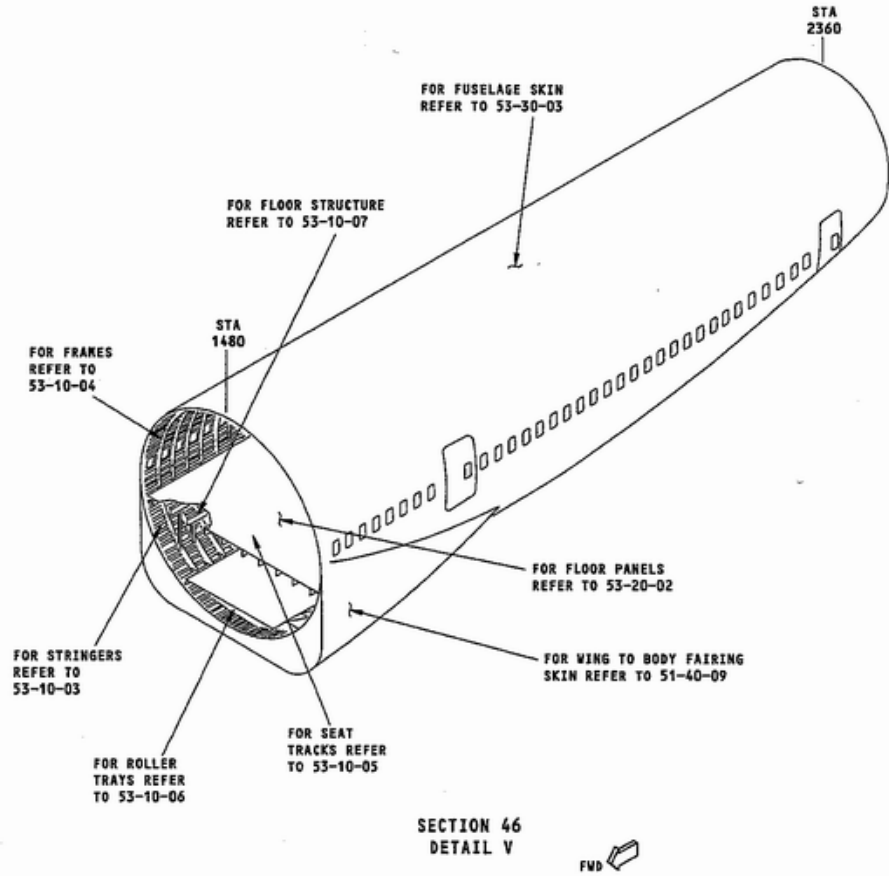

811164

Fuselage Structure Repair Index
Figure 1 (Sheet 5)

747 SRM

53-10-00
Page 5
Mar 15/94

BOEING
747
STRUCTURAL REPAIR

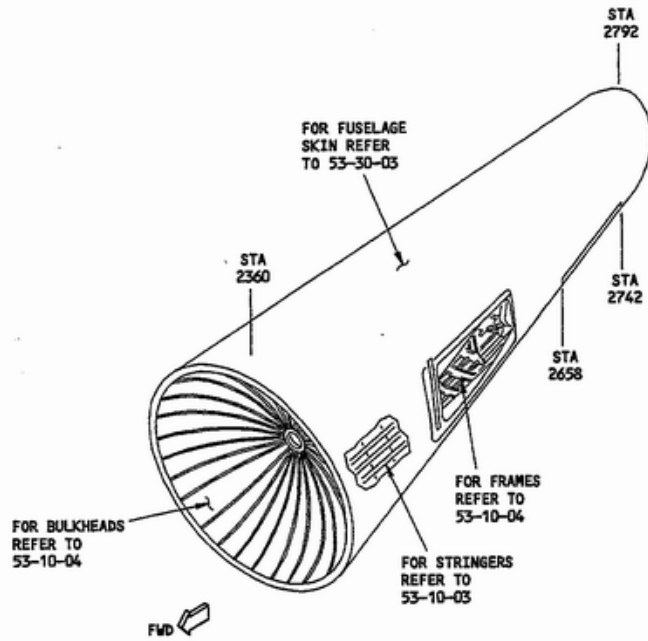

SECTION 48
DETAIL VI

Fuselage Structure Repair Index
Figure 1 (Sheet 6)

E11165

53-10-00

Page 6
Mar 15/94

747 SRM

BOEING
747
STRUCTURAL REPAIR

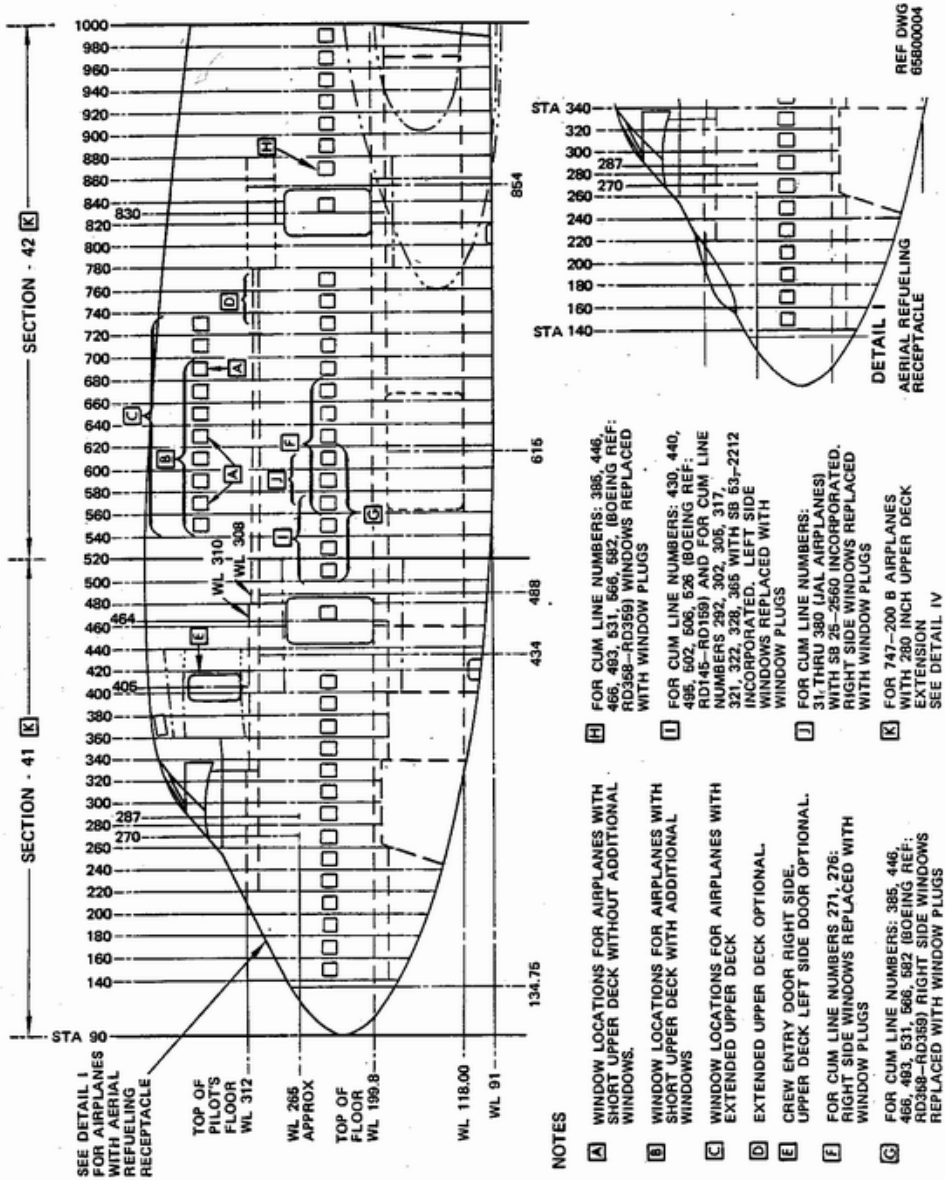

- NOTES**
- A** WINDOW LOCATIONS FOR AIRPLANES WITH SHORT UPPER DECK WITHOUT ADDITIONAL WINDOWS.
 - B** WINDOW LOCATIONS FOR AIRPLANES WITH SHORT UPPER DECK WITH ADDITIONAL WINDOWS
 - C** WINDOW LOCATIONS FOR AIRPLANES WITH EXTENDED UPPER DECK
 - D** EXTENDED UPPER DECK OPTIONAL.
 - E** CREW ENTRY DOOR RIGHT SIDE, UPPER DECK LEFT SIDE DOOR OPTIONAL.
 - F** FOR CUM LINE NUMBERS 271, 276; RIGHT SIDE WINDOWS REPLACED WITH WINDOW PLUGS
 - G** FOR CUM LINE NUMBERS: 385, 446, 466, 483, 531, 566, 592 (BOEING REF: RD388-RD389) RIGHT SIDE WINDOWS REPLACED WITH WINDOW PLUGS
 - H** FOR CUM LINE NUMBERS: 395, 446, 466, 483, 531, 566, 592 (BOEING REF: RD388-RD389) WINDOWS REPLACED WITH WINDOW PLUGS
 - I** FOR CUM LINE NUMBERS: 430, 440, 485, 502, 506, 526 (BOEING REF: RD145-RD159) AND FOR CUM LINE NUMBERS 292, 302, 306, 317, 321, 322, 328, 365 WITH SB 53-2212 INCORPORATED. LEFT SIDE WINDOWS REPLACED WITH WINDOW PLUGS
 - J** FOR CUM LINE NUMBERS: 311, 312, 321, 322, 328, 365 (BOEING REF: SB 53-2212) INCORPORATED. RIGHT SIDE WINDOWS REPLACED WITH WINDOW PLUGS
 - K** FOR 747-200 B AIRPLANES WITH 280 INCH UPPER DECK EXTENSION SEE DETAIL IV

Fuselage Station Diagram - 747-100 and 747-200B
Figure 1 (Sheet 1)

53-00-01
Page 1
Mar 15/85

747 SRM

BOEING
747
STRUCTURAL REPAIR

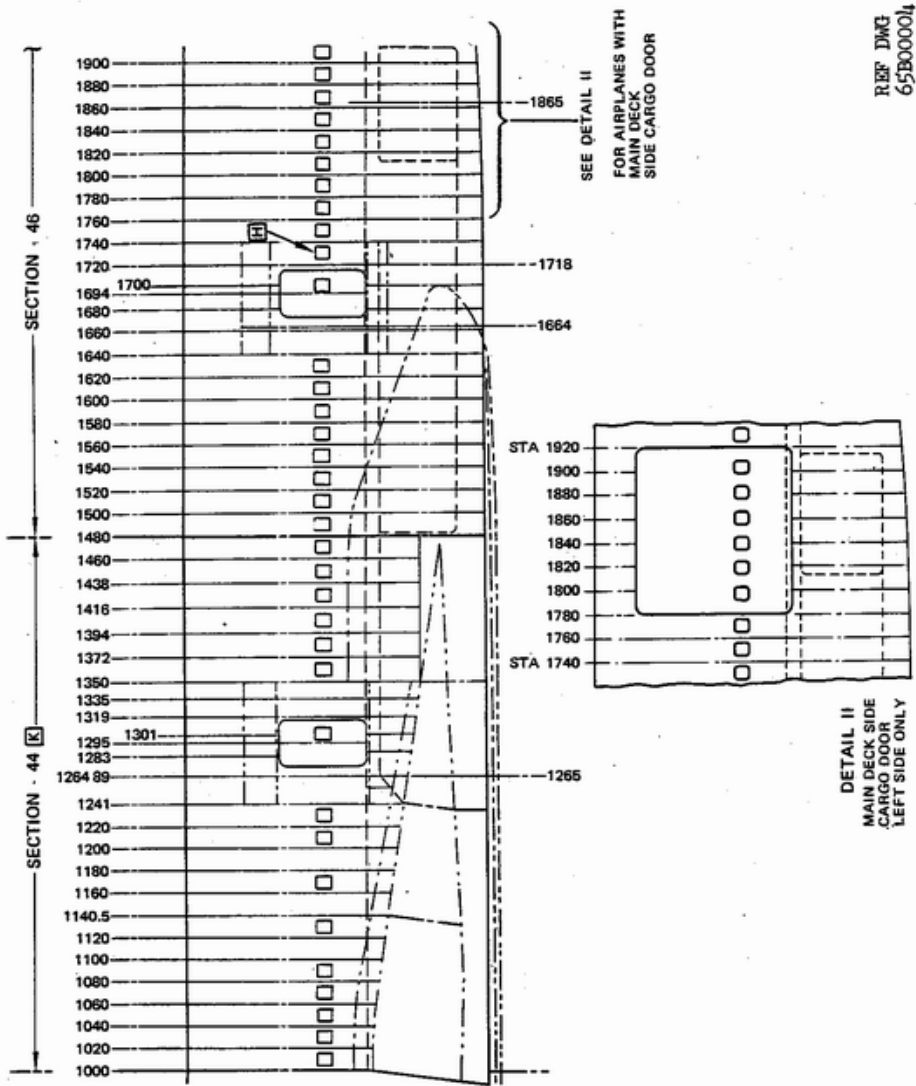

Fuselage Station Diagram - 747-100 and 747-200B
Figure 1 (Sheet 2)

53-00-01

Page 2
Sep 15/84

747 SRM

BOEING
747
STRUCTURAL REPAIR



REF DWG
65B00004

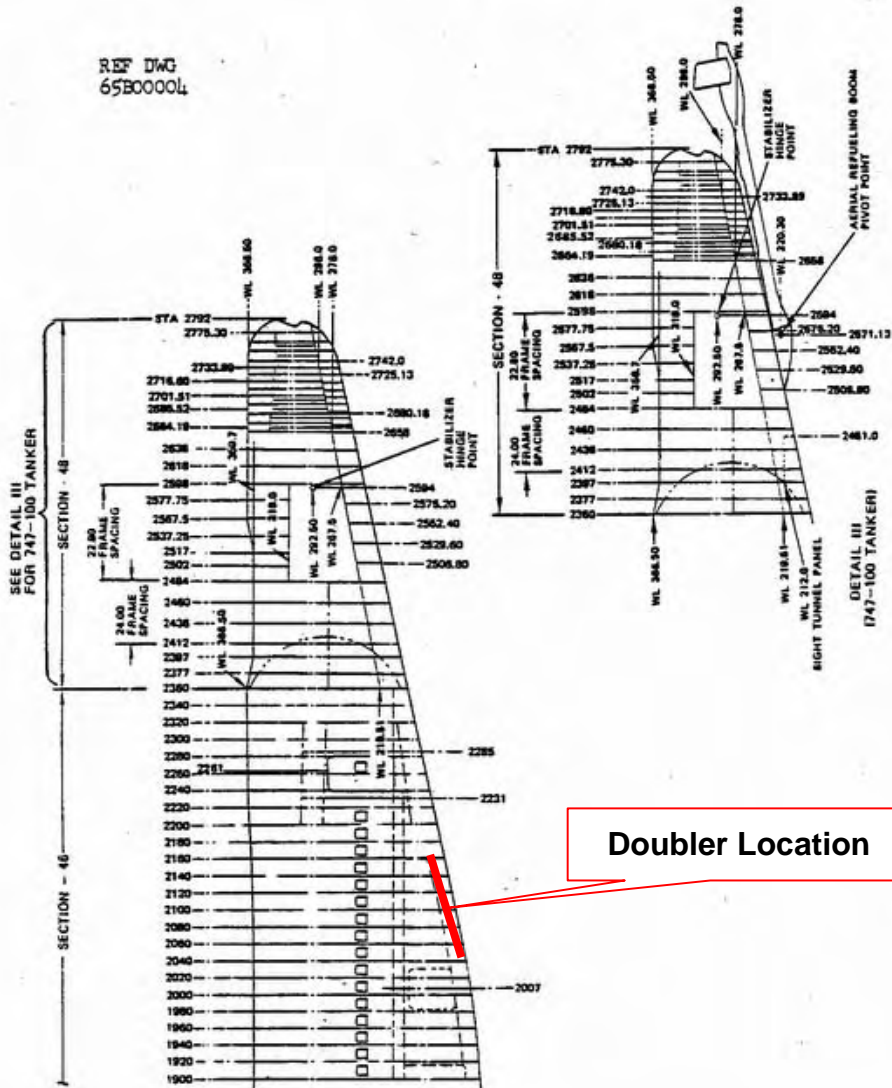

Fuselage Station Diagram - 747-100 and 747-200B
Figure 1 (Sheet 3)

53-00-01

Page 2A
Sep 15/84

747 SRM

BOEING
747
STRUCTURAL REPAIR

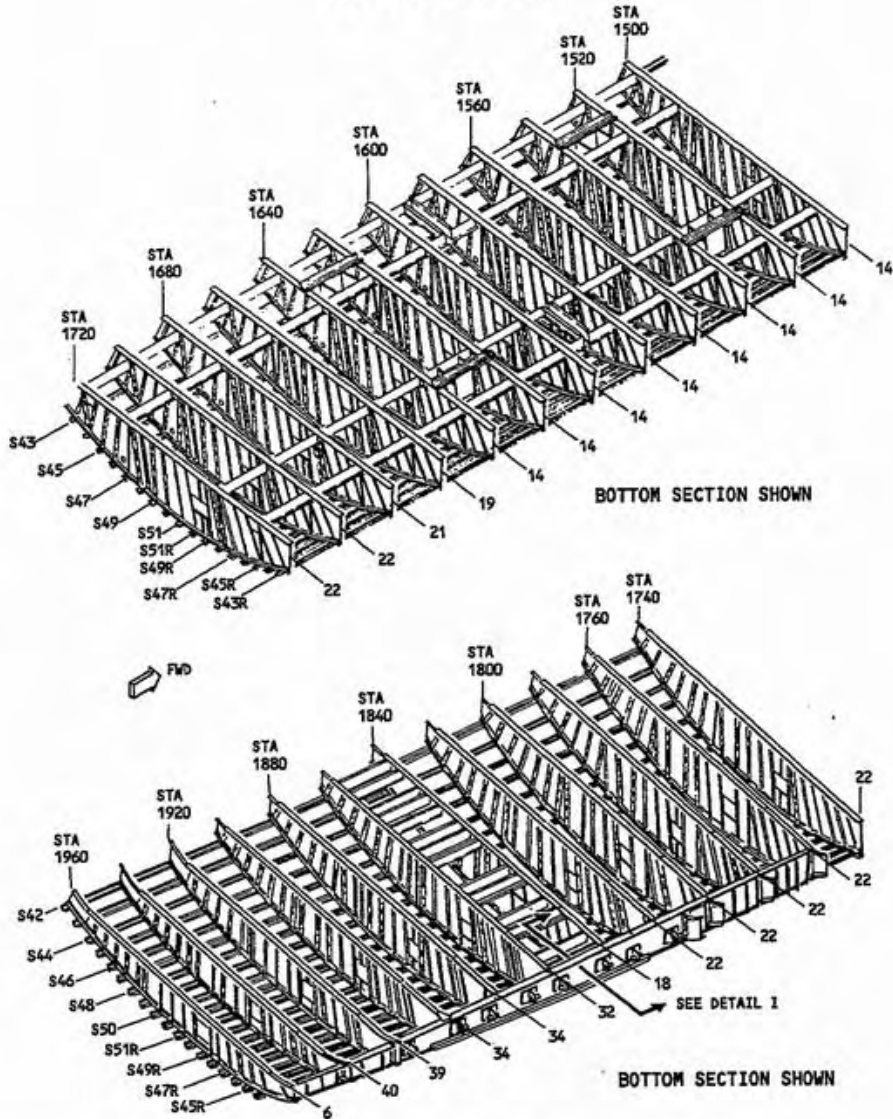

Structure Identification - Section 46 - 747-200C and 747-200F
Figure 1 (Sheet 15)

AS6945

747 SRM

53-11-23

Page 2N
Mar 15/94



ITEM	DESCRIPTION	GAGE	MATERIAL	EFFECTIVITY
1	UPR AUX SILL WEB	0.040	CLAD 7075-T62	
2	UPR MAIN SILL FWD AND AFT WEB CTR WEB SEAL DEPRESSOR INNER CHORD OUTER CHORD	0.040 0.090	CLAD 7075-T6 2024-T3 BAC1496-388 CLAD 7075-T6 BAC1514-2045 7075-T6511 OPTIONAL: BAC1514-1128 7075-T6 BAC1514-2097 2024-T3511 OPTIONAL: BAC1514-1128 2024-T42	
3	LWR MAIN SILL AFT WEB FWD WEB STR WEB FWD CTR WEB SEAL DEPRESSOR OUTBD CHORD INBD CHORD FWD STRAP AFT CTR STRAP AFT STRAP CTR STRAP	0.071 0.040 0.100 0.063 0.180 0.100 0.375 0.250	CLAD 7075-T6 CLAD 7075-T6 7075-T6 7075-T6 BAC1493-620 CLAD 7075-T6 BAC1514-2046 2024-T3511 OPTIONAL: BAC1514-1128 2024-T42 BAC1503-100213 7075-T6511 OPTIONAL: AND10133-2403 7075-T6511 7075-T6 CLAD 7075-T6 7075-T6 7075-T6	
4	LWR AUX SILL WEB ANGLE	0.040	CLAD 7075-T6 AND10133-0703 7075-T6511	
5	FWD STUB BEAM UPR CAP LWR CAP WEB STIFFENER	0.040	BAC1503-2772 7075-T6511 BAC1506-2450 7075-T6511 CLAD 7075-T6 AND10134-0601 7075-T6511	
6	AFT STUB BEAM UPR CAP LWR CAP WEB STIFFENER	0.040	BAC1503-2772 7075-T6511 BAC1510-856 7075-T6511 CLAD 7075-T6 AND10134-0601 7075-T6511	
7	FWD FRAME OUTER CHORD INNER CHORD WEB ANGLE	[A]	BAC1503-100370 2024-T42 OPTIONAL: BAC1514-1522 2024-T42 BAC1503-100369 7075-T6 OPTIONAL: BAC1514-15 7075-T6 7075-T6 AND10134-2001 7075-T6	
8	INTERCOSTAL	0.050	CLAD 7075-T6	
9	INTERCOSTAL	0.063	7075-T6	

LIST OF MATERIALS FOR DETAIL VI

Structure Identification - Section 46 - 747-200C and 747-200F
Figure 1 (Sheet 25)

ED08145

747 SRM

53-11-23

Page 2Y
Mar 15/94

此頁空白

附錄 3 華航工程建議 ERE (747) - AS062 文件

CHINA AIRLINES

FEBRUARY 8, 1980
REF: ERE(747)AS062

ENGINEERING RECOMMENDATION
747 B1866 ACFT

I. Description of Damage:

B-1866 low fuselage aft section damage occurred during landing with dragged tail on runway in HKG.

Preliminary inspection found the serious abrasion damages on fuselage tail portion bottom skin between F.S. 2080 and 2160 and between F.S. 2578 and 2638. The aft drain mast was missing. LH outflow valve door inb'd corner partially cut.

II. Recommended Actions: (Structural Repair)

1. Close visual inspect internal structure for any defects inside the abraded skin.
2. Install two reinforcing doublers, made of .063" 7075-T6 Alum. Alloy plates at two places of the abraded area, forward 23"x125" (to be sealed during installation on this pressurized area) and aft 15"x54". See attach Figure.
3. Aft water drain mast reinstalled and functional test.
4. LH outflow valve door cut area temporarily repaired with 6061-T6 Alum. Alloy and functional test.
5. Conduct permanent repair IAW 747 SEM within four months.
6. The said temporary repair was concurred by Boeing Rep.

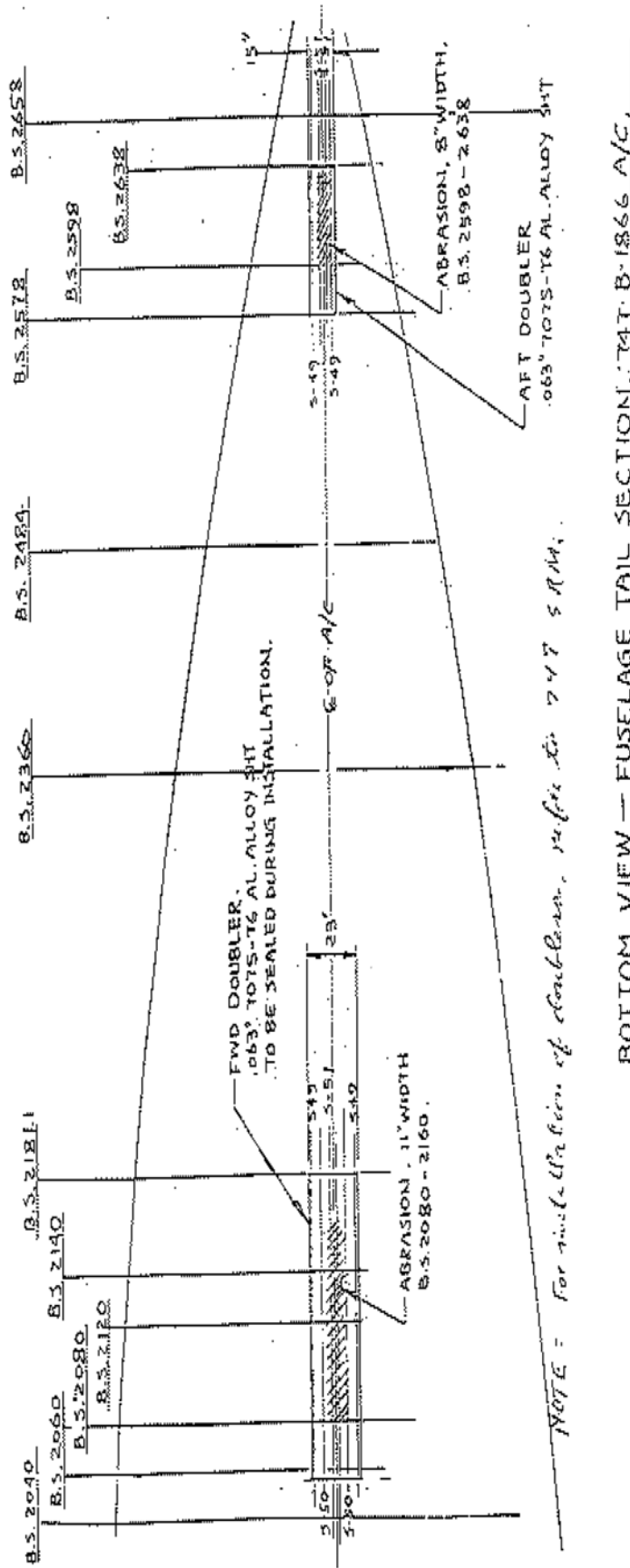

附錄 4 波音編號 BFSTPE CI-TPE-80-22TE 電報

FURTHER TO REF CMA B-1866 FERRIED TPE 2-7-80 WITH CABIN UNPRESSURIZED PRECAUTIONARY PD TPE LANDING UNEVENTFUL PD AT TPE CMA INSP FOUND TAIL SECT LWR SURFACE DAMAGED TO WHAT APPEAR TO HAVE BEEN SUSTAINED A LIGHTLY TAIL DRAGGED ORD ON RUNWAY DURING LANDING WITH ABRASION DAMAGES CENTERED AT AFT LWR FUSELAGE SKIN PNLS PD SKIN ABRASION DAMAGES WITH AVERAGE DEPTH OF .30IN AT STA 2080-2160 BETWEEN S-50R AND S-49L CMA STA 2484-2658 BETWEEN S-50R AND S-50L WITH AVERAGE DEPTH OF .25-.30 OF ABRASION PD AT STA 2086 AND 2598 CMA AN AREA OF .2X.4IN AND 4X8IN RESPECTIVELY THAT HEAVY ABRASION UP TO SKIN THICKNESS WERE SUSTAINED AT CL OF LWR FUSELAGE SKIN PNLS PD IN ADDITION CMA AFT WATER DRAIN FAST WAS BROKEN OFF AND LH OUTFLOW VALVE LWR GATE INBD LWR CORNER 2X4IN CUT-AWAY PD NO OTHER DAMAGES ON BOBY FRMS OR STRINGERS FOUND PD CI TEMP REPAIRED ABOVE BY ADDITION OF EXT TEMP SKIN PATCHES OF .063 CLAD 2024-T3 AT STA 2080-2131.1 BETWEEN S-49R AND S-49L AND AT STA 2579-2618 BETWEEN S-49R AND S-49L PD SKIN REPLACEMENT OR SKIN REPAIR PER SRM OF EXTERNAL PATCH METHOD TO TOTAL DAMAGED AREA TO BE MADE AT LATE DATE UPON REPLACEMENT P

RTS ORDERED THRU NORMAL CHANNEL PD THE AFT WATER DRAIN FAST REPLACED AND LH OUTFLOW VALVE LWR GATE DAMAGED AREA TEMP REPAIRED AND OUTFLOW VALVE LWR GATE TO BE REPLACED UPON REPLACEMENT P

RT ORDERED PD A/C RETURNED TO SERVICE ON 2-8-80 AS SCHED WITHOUT MAINT DELAY PD

此頁空白

附錄 5 波音 B-H200-17660-ASI 信函

9 May 2003

B-H200-17660-ASI

Aviation Safety Council

16th Floor, 99 Fu-Hsing North Road

Taipei 105, Taiwan, R.O.C

Subject: 1980 Tailstrike Event - China Airlines 747-200 B-18255 Accident
near Makung, Taiwan - 25 May 2002

Reference: a) Your email to Simon Lie, dated 24 February 2003
b) Telex CI-TPE-80-21TE, dated 7 February 1980
c) Telex CI-TPE-80-22TE, dated 8 February 1980
d) Telex CI-TPE-80-24TE, dated 11 February 1980

We received the reference a) email requesting information about communication between China Airlines and Boeing regarding the tailstrike event on 7 February 1980 in Hong Kong. Attached is our response to your questions.

The information included with this correspondence is considered confidential commercial information of Boeing and is provided on a confidential basis for the exclusive use of the ASC and other investigative parties in connection with

their investigative activities. Boeing does not authorize release of this information to the public.

If you have any questions, please don't hesitate to contact Simon Lie at +1 425 234-5471.

Very truly yours,

(original signed by)

Background

Since mid 2002, Boeing has been searching for records pertaining to the tailstrike event that occurred on 7 February 1980 in Hong Kong and the subsequent temporary and permanent repairs. Our search has included our field services offices in Hong Kong and Taipei, as well as our facilities in the Seattle area. We have searched through telexes from our field services offices, repair records and databases retained by our structural engineering group, and other files. Our search produced the reference b), c), and d) telexes which have previously been provided to the ASC. Also, we have spoken with Boeing Representatives stationed in Hong Kong and Taipei during February 1980. The Boeing Representative stationed in Taipei has since retired from the Boeing Company. Below are listed your questions followed by our answers, which are based on the records found during our search.

Question

Did Boeing Representative to China Airlines receive the information to the incident of tail strike from China Airlines?

Answer

According to reference a), the Boeing Representative in Hong Kong (BFSHKG) assisted China Airlines with the initial inspection of the damage in Hong Kong. We have found no records indicating whether the Boeing Representative to China Airlines (BFSTPE) received information regarding the initial inspection from BFSHKG, China Airlines, or both.

Question

Was there an official request/record of such request by China Airlines to Boeing in providing comments or recommendations to China Airlines regarding the tail strike repair? If comments / recommendations were provided by Boeing to CAL, could Boeing provide those records to ASC?

Answer

We have no record of any request by China Airlines for Boeing to comment or provide recommendations regarding the tail strike repair.

Note that China Airlines has provided the investigation with a copy of

“Engineering Recommendation Ref: ERE(747)AS062”, dated 8 February 1980.

That document states that the temporary repair was concurred by BFSTPE on 7 February 1980 and that a copy was provided to BFSTPE.

Question

After the repair was done, did Boeing Representative acknowledge the repair procedures done by China Airlines, and if so, could Boeing provide the record of such acknowledgement? If no acknowledgement was provided, please state the reason why.

Answer

In reference b), BFSTPE advised Boeing that China Airlines had accomplished a temporary repair consisting of temporary skin patches made from .063 clad 2024-T3. BFSTPE further advised that China Airlines intended to complete a skin replacement or external patch permanent repair per SRM at a later date.

We have found no record that indicates Boeing was advised that the permanent repair had been completed.

附錄 6 華航 B-1866 (B-18255) 航空器經歷簿民國 69 年紀錄

飛機 AIRCRAFT	747-B1866	裝置發動機 ENGINE(S) INSTALLED	序號 Serial No.	p695793	位置 Position	#1	序號 Serial No.	p695794	位置 Position	#2
			序號 Serial No.	p666057	位置 Position	#3	序號 Serial No.	p695753	位置 Position	#4
(1) 轉記時數 HOURS BROUGHT FORWARD		飛機總時數—小時 Time Since New - Hours		2181	分 Min	37	轉記著陸次數 LANDING NUMBERS BROUGHT FORWARD		519	
		上次翻修後時數 Time Since Last Overhaul - Hours		小時	分		本頁著陸次數 LANDING NUMBERS		35	
								PAGE TOTAL		35

日期 Date	留空時間 Time in Air (2)		著陸 次數 LDGS	(3) ※ 將檢查、小修及頒發之修妥簽證全部詳細資料登記於下欄內。 Enter full details of Inspections, Minor Repairs and Maintenance Release Certificates issued hereunder
	小時 Hrs.	分 Min.		
Feb. 1 '80	10	30	2	
2	13	37	2	
3	13	35	2	
4	15	27	2	
5	/	/		PFM 2 BOK
6	5	15	2	
7	2	21	2	
8	10	29	2	
9	12	51	2	
10	13	27	2	
11	15	08	2	
12	12	51	4	
13	13	34	2	
14	5	45	3	PFM 11 ACK
15	16	52	6	
本頁總計 Page Total	161	42		

※在登記事項之右方或下方簽名，以證明所登記之事項無訛。
A signature under or in line with the entry in this page will be taken as a certification that the entry is correct.

014

飛機 AIRCRAFT	747-B1866	裝置發動機 ENGINE(S) INSTALLED	序號 Serial No.	p695793	位置 Position	#1	序號 Serial No.	p695794	位置 Position	#2
			序號 Serial No.	p666057	位置 Position	#3	序號 Serial No.	p695753	位置 Position	#4
(1) 轉記時數 HOURS BROUGHT FORWARD		飛機總時數—小時 Time Since New - Hours		2343	分 Min	19	轉記著陸次數 LANDING NUMBERS BROUGHT FORWARD		554	
		上次翻修後時數 Time Since Last Overhaul - Hours		小時	分		本頁著陸次數 LANDING NUMBERS		35	
								PAGE TOTAL		35

日期 Date	留空時間 Time in Air (2)		著陸 次數 LDGS	(3) ※ 將檢查、小修及頒發之修妥簽證全部詳細資料登記於下欄內。 Enter full details of Inspections, Minor Repairs and Maintenance Release Certificates issued hereunder
	小時 Hrs.	分 Min.		
Feb. 16 '80	13	58	2	
17	13	18	2	
18	16	16	2	
19	12	47	4	
20	14	40	2	
21	5	43	3	
22	13	01	4	
23	14	12	2	
24	13	38	2	
25	16	13	2	
26	/	/		
27	5	27	2	
28	14	41	4	
29	11	57	4	
本頁總計 Page Total	165	51		

※在登記事項之右方或下方簽名，以證明所登記之事項無訛。
A signature under or in line with the entry in this page will be taken as a certification that the entry is correct.

015

飛機 747-B1368 裝置發動機 序號 P695793 位置 #1 序號 P695794 位置 #2
 AIRCRAFT ENGINE(S) INSTALLED 序號 P686057 位置 #3 序號 P695753 位置 #4

轉記時數 (1) HOURS BROUGHT FORWARD 飛機總時數—小時 2569 分 10 轉記看陸次數 LANDING NUMBERS BROUGHT FORWARD 589
 上次翻修復時數 小時 分 上次翻修復時數 小時 分 本頁看陸次數 LANDING NUMBERS PAGE TOTAL 91

日期 Date	留空時間 Time in Air (2)		著陸 次數 DGS	(3) * 將檢查、小修及頒發之修妥簽證全部詳細資料登記於下欄內。 Enter full details of Inspections, Minor Repairs and Maintenance Release Certificates issued hereunder
	小時 Hrs.	分 Min.		
Mar. 1 '80	5	57	2	
2	11	07	1	
3	15	39	2	
4	2	16	2	
5	5	36	2	
6	13	52	4	
7	12	29	4	
8	5	28	2	PFM 12 A CK
9	11	13	1	
10	14	57	2	
11	10	39	2	
12	13	21	2	
13	3	02	1	
14	10	51	2	
15	13	49	2	
本頁總計 Page Total	150	16		

※在登記事項之右方或下方簽名，以證明所登記之事項無訛。
 A signature under or in line with the entry in this page will be taken as a certification that the entry is correct.

016

飛機 747-B1368 裝置發動機 序號 P695793 位置 #1 序號 P695794 位置 #2
 AIRCRAFT ENGINE(S) INSTALLED 序號 P686057 位置 #3 序號 P695753 位置 #4

轉記時數 (1) HOURS BROUGHT FORWARD 飛機總時數—小時 2659 分 26 轉記看陸次數 LANDING NUMBERS BROUGHT FORWARD 620
 上次翻修復時數 小時 分 上次翻修復時數 小時 分 本頁看陸次數 LANDING NUMBERS PAGE TOTAL 33

日期 Date	留空時間 Time in Air (2)		著陸 次數 DGS	(3) * 將檢查、小修及頒發之修妥簽證全部詳細資料登記於下欄內。 Enter full details of Inspections, Minor Repairs and Maintenance Release Certificates issued hereunder
	小時 Hrs.	分 Min.		
Mar. 16 '80	13	48	2	
17	15	39	2	
18	5	23	2	
19	5	26	2	
20	13	17	2	
21	22	58	3	
22	15	03	2	
23	10	34	1	
24	14	08	2	
25	10	35	2	
26	12	46	2	
27	3	19	1	PFM 1A CK
28	13	01	4	
29	12	25	2	
30	14	00	2	
31	14	45	2	
本頁總計 Page Total	197	07		

※在登記事項之右方或下方簽名，以證明所登記之事項無訛。
 A signature under or in line with the entry in this page will be taken as a certification that the entry is correct.

017

飛機 AIRCRAFT **747-B1866** 裝置發動機 ENGINE(S) INSTALLED

序號 p695793 位置 # 1 序號 p695794 位置 # 2
 序號 p688057 位置 # 3 序號 p695753 位置 # 4

飛機總時數—小時 2856 分 33 轉記著陸次數 653
 上次翻修後時數 小時 分 本頁著陸次數 36
 Time Since Last Overhaul - Hours Min. LANDING NUMBERS BROUGHT FORWARD

(1) 轉記時數 (HOURS BROUGHT FORWARD)

日期 Date	留空時間 Time in Air (2)		著陸 次數 LDGS	(3) ※ 將檢查、小修及頒發之修妥簽證全部詳細資料登記於下欄內。 Enter full details of Inspections, Minor Repairs and Maintenance Release Certificates issued hereunder
	小時 Hrs.	分 Min.		
Apr. 1 '80	10	37	2	
2	12	23	2	
3	7	31	5	
4	13	04	4	
5	12	39	2	
6	13	26	2	
7	15	27	2	
8	10	19	2	
9	12	38	2	
10	3	05	1	
11	13	26	4	
12	12	15	2	
13	14	05	2	
14	15	16	2	
15	10	48	2	
本頁總計 Page Total	176	59		

※在登記事項之右方或下方簽名，以證明所登記之事項無訛。
 A signature under or in line with the entry in this page will be taken as a certification that the entry is correct.

018

飛機 AIRCRAFT **747-B1866** 裝置發動機 ENGINE(S) INSTALLED

序號 p695793 位置 # 1 序號 p695794 位置 # 2
 序號 p688057 位置 # 3 序號 p695753 位置 # 4

飛機總時數—小時 3033 分 32 轉記著陸次數 689
 上次翻修後時數 小時 分 本頁著陸次數 32
 Time Since Last Overhaul - Hours Min. LANDING NUMBERS BROUGHT FORWARD

(1) 轉記時數 (HOURS BROUGHT FORWARD)

日期 Date	留空時間 Time in Air (2)		著陸 次數 LDGS	(3) ※ 將檢查、小修及頒發之修妥簽證全部詳細資料登記於下欄內。 Enter full details of Inspections, Minor Repairs and Maintenance Release Certificates issued hereunder
	小時 Hrs.	分 Min.		
Apr. 16 '80	12	05	2	
17	3	03	1	PFM 2A OK
18	12	51	4	
19	12	02	2	
20	13	55	2	
21	15	09	2	
22	10	38	2	
23	12	32	2	
24	3	05	1	
25	12	36	4	
26	12	01	2	
27	13	55	2	
28	14	27	2	
29	5	17	2	
30	5	25	2	
本頁總計 Page Total	159	01		

※在登記事項之右方或下方簽名，以證明所登記之事項無訛。
 A signature under or in line with the entry in this page will be taken as a certification that the entry is correct.

019

飛機 AIRCRAFT **747-B1866** 裝置發動機 ENGINE(S) INSTALLED 序號 0695793 位置 #1 序號 0695794 位置 #2
 序號 0686057 位置 #3 序號 0695753 位置 #4

(1) 轉記時數 (HOURS BROUGHT FORWARD) 飛機總時數—小時 Time Since New - Hours 3192 分 33 轉記著陸次數 LANDING NUMBERS BROUGHT FORWARD 721
 上次翻修後時數 小時 Time Since Last Overhaul - Hours 分 本頁著陸次數 LANDING NUMBERS PAGE TOTAL 33

日期 Date	留空時間 Time in Air (2)		著陸 次數 DGS	(3) ※ 將檢查、小修及頒發之修安簽證全部詳細資料登記於下欄內。 Enter full details of Inspections, Minor Repairs and Maintenance Release Certificates issued hereunder
	小時 Hrs.	分 Min.		
May 1 '80	12	55	3	
2	12	22	3	
3	5	17	2	
4	12	32	3	
5	15	48	3	
6	13	32	3	
7	15	11	3	
8	/	/	/	PFM 3B + 3A CV
9	10	54	2	
10	12	25	2	
11	13	47	2	
12	14	55	2	
13	10	46	2	
14	11	45	2	
15	2	43	1	
本頁總計 Page Total	164	52		

※在登記事項之右方或下方簽名，以證明所登記之事項無訛。
 A signature under or in line with the entry in this page will be taken as a certification that the entry is correct.

020

飛機 AIRCRAFT **747-B1866** 裝置發動機 ENGINE(S) INSTALLED 序號 0695793 位置 #1 序號 0695794 位置 #2
 序號 0686057 位置 #3 序號 0695753 位置 #4

(1) 轉記時數 (HOURS BROUGHT FORWARD) 飛機總時數—小時 Time Since New - Hours 3357 分 25 轉記著陸次數 LANDING NUMBERS BROUGHT FORWARD 754
 上次翻修後時數 小時 Time Since Last Overhaul - Hours 分 本頁著陸次數 LANDING NUMBERS PAGE TOTAL 22

日期 Date	留空時間 Time in Air (2)		著陸 次數 DGS	(3) ※ 將檢查、小修及頒發之修安簽證全部詳細資料登記於下欄內。 Enter full details of Inspections, Minor Repairs and Maintenance Release Certificates issued hereunder
	小時 Hrs.	分 Min.		
May 16 '80	10	45	2	
17	10	52	2	
18	13	44	2	
19	14	25	2	
20	11	02	2	
21	12	11	2	
22	2	52	1	
23	/	/	/	1/2 GROUND FOR FUSELAGE BOTTOM REPAIR
24	/	/	/	
25	/	/	/	
26	/	/	/	
27	11	27	2	
28	11	40	2	
29	3	00	1	
30	11	06	2	
31	11	47	2	
本頁總計 Page Total	124	51		

※在登記事項之右方或下方簽名，以證明所登記之事項無訛。
 A signature under or in line with the entry in this page will be taken as a certification that the entry is correct.

021

附錄 7 華航 B-1866 (B-18255) 民國 69 年機尾觸地事件相關維修紀錄

重大修理及翻修紀錄
MAJOR REPAIR AND OVERHAUL RECORD

工 作 內 容 詳 情
Detail of Work Done, etc.

AFT BELLY SKIN SCRATCH (25, MAY '80)

1. PEEL AREA CUT OUT + TRIMMED.
2. PATCHED WITH DOUBLER
3. ACCOMPLISHED AFT BELLY SKIN REPAIR I.A.W. PAL ENGR. RECOMMENDATION & DRAWING
SNM 17-30-03 FIG. 1.

此頁空白

附錄 8 天氣資料

Wind Profile (MM5/ATS, ASC)			Wind Profile (MM5/RE, NTSB)		
Alt.	Wind dir.	Wind Speed	Alt.	Wind dir.	Wind Speed
0	20	16	306.4	11	10
1000	360	17	4921	90	3.8
2000	340	10	10266	278	15.2
3000	300	6	14417	276	18.8
4000	280	5	19189	270	23.5
5000	270	4	24837	266	27.4
6000	270	4	31788	263	33
7000	270	5	35977	260	35.3
8000	280	7	40871	257	37.2
9000	280	8			
10000	280	10			
11000	280	12			
12000	280	13			
13000	270	15			
14000	270	17			
15000	270	18			
16000	270	16			
17000	260	19			
18000	260	20			
19000	260	20			
20000	250	21			
21000	250	21			
22000	250	22			
23000	240	22			
24000	240	23			
25000	240	25			
26000	240	26			
27000	240	27			
28000	250	29			
29000	250	30			
31000	250	33			

Wind Profile (MM5/ATS, ASC)			Wind Profile (MM5/RE, NTSB)		
Alt.	Wind dir.	Wind Speed	Alt.	Wind dir.	Wind Speed
33000	250	36			
35000	250	38			
37000	250	40			
39000	250	40			
41000	250	38			
43000	250	35			
45000	250	32			
41000	250	38			
43000	250	35			
45000	250	32			

附錄 9 CI611 座艙語音紀錄器抄件

Legend

CM1: Captain

CM2: First Officer

CM3: Flight Engineer

RDO1: Radio transmission from CM1

RDO2: Radio transmission from CM2

RDO3: Radio transmission from CM3

MAINT: Gound marshall

GND: Taipei Ground Control

TWR: Taipei Tower Control

APP: Taipei Approach

ACC: Taipei Area Control Center

PRAM: Prerecorded announcement

FA: Flight attendant

VOLMET: Meteorological information for aircraft in flight

OPS: China Airlines' Operations Center

CAM: Cockpit Area Microphone

CAM1: CM1 through cockpit area microphone

CAM2: CM2 through cockpit area microphone

CAM3: CM3 through cockpit area microphone

MFXXX: an unknown flight of Xiamen Airlines

XX FOC: unknown airlines flight operations center

XX 057: unknown airlines flight 057

--: unintelligible words

ALL_TK: source including track1, track2, track3 and track4

() : remarks or translation

Local Time (radar time)	SOURCE	CONTENT
14:56:12		(beginning of record)
14:56:13	PRAM	您好歡迎搭乘華航...(Welcome on board China Airlines)
14:56:13	CAM	(sound similar to engine ignition switch movement)
14:56:14	CAM3	starter cutout
14:56:15	GND	(conversation with BR 802)
14:56:15	CAM1	after start items
14:56:17	CM1	ground cockpit
14:56:18	MAINT	go ahead
14:56:19	CM1	ready for flaps check leading edge
14:56:21	MAINT	roger ground cleared
14:56:21	BR 802	(conversation with TPE GND)
14:56:22	CAM1	flaps twenty
14:56:22	CAM	(sound similar to flap lever movement)
14:56:23	CAM2	twenty
14:56:29	CAM	(unidentified sound)
14:56:31	CAM1	ok after start check list
14:56:32	CAM2	after start anti ice
14:56:34	CAM1	off off
14:56:35	MAINT	yes sir we are confirm leading edge flaps extended
14:56:36	CAM2	electrical panel
14:56:37	CAM3	all check
14:56:38	CAM2	cargo heat
14:56:38	CAM3	normal
14:56:38	CM1	leading edge extended and prepared aircraft for taxi see your signal bye bye
14:56:39	CAM2	hydraulic system
14:56:39	CAM3	check
14:56:43	MAINT	yes sir -- bye bye
14:56:44	PRAM	--收發報--遙控器全程禁用—(transmitter.. remote control devices are prohibited at all time)
14:56:45	CAM2	after start check list complete
14:56:47	CAM	(unidentified sound)

Local Time (radar time)	SOURCE	CONTENT
14:56:48	CAM	(unidentified sound)
14:56:50	CAM	(sound similar to electric seat motor)
14:56:54	CAM	(unidentified sound)
14:57:02	CAM	--
14:57:06	RDO2	taipei dynasty six one one taxi
14:57:09	GND	dynasty six one one taxi via taxiway sierra sierra hold short taxiway sierra five
14:57:10	CAM	(sound similar to parking brake release)
14:57:15	RDO2	taxi via sierra sierra hold short sierra five dynasty six one one
14:57:20	CAM2	sierra papa 下面一個轉彎 (next turn)
14:57:21	GND	(conversation with BR 2196)
14:57:23	CAM	--
14:57:26	BR 2196	(conversation with TPE GND)
14:57:30	CAM1	taxi items flight controls
14:57:33	CAM3	ya left -- right one down
14:57:36	CAM3	left -- down right two up two down two up
14:57:38	CI 031	(conversation with OPS)
14:57:42	CAM1	rudder
14:57:44	CAM3	full left full right neutral
14:57:45	CI 031	(converation with OPS)
14:57:48	CAM	(sound similar to seat motor)
14:57:48	OPS	(conversation with CI 031)
14:57:49	CAM1	taxi check list please
14:57:50	CI 031	(conversation with OPS)
14:57:56	OPS	(conversation with CI 031)
14:57:56	CI 031	(conversation with OPS)
14:57:57	CAM1	taxi check list
14:57:58	CAM3	check list
14:58:04	CAM3	flight instruments
14:58:05	CAM1	check
14:58:06	CAM2	check
14:58:07	CAM3	flight controls

Local Time (radar time)	SOURCE	CONTENT
14:58:08	CAM1	check
14:58:08	CAM2	check
14:58:10	CAM3	flaps
14:58:11	CAM1	twenty twenty green
14:58:12	CAM2	twenty twenty green
14:58:13	CAM3	twenty twenty green
14:58:15	CAM3	trim
14:58:16	CAM1	four zero zero
14:58:18	NX628	(conversation with TPE GND)
14:58:19	CAM2	four zero zero
14:58:20	CAM3	ok apu out
14:58:22	CAM3	adp check
14:58:22	GND	(conversation with NX628)
14:58:23	CAM3	brake temp check
14:58:24	CAM3	taxi check completed
14:58:25	CAM1	thank you
14:58:28	CAM1	takeoff briefing
14:58:29	CAM2	okay
14:58:30	CAM2	okay after takeoff maintain runway heading until number two dme 四哩 (<i>four nautical miles</i>)
14:58:31	NX628	(conversation with TPE GND)
14:58:36	CAM2	左轉兩三五攔截 (<i>left turn 235 to intercept</i>)
14:58:37	CAM1	number one dme
14:58:38	CAM2	oh number one dme
14:58:38	GND	(conversation with BR 2196)
14:58:42	BR 2196	(conversation with TPE GND)
14:58:43	CAM2	四哩左轉兩三五攔截鞍部兩六洞 (<i>four nautical miles left turn 235 to intercept APU 260</i>)
14:58:46	CAM	(unidentified sound similar)
14:58:47	CAM2	到 (<i>to</i>) jessy after jessy direct 到 (<i>to</i>) chali 馬公 (<i>Makung</i>)
14:58:52	CAM2	我們的第一點改為 (<i>our first waypoint change to</i>) jessy
14:58:54	CAM1	Jessy

Local Time (radar time)	SOURCE	CONTENT
14:58:55	CAM2	第二點 (<i>second waypoint</i>) chali
14:58:55	GND	dynasty six one one continue taxi via taxiway whiskey charlie sierra papa to runway zero six
14:58:57	CAM	(unidentified sound)
14:59:02	RDO2	via whiskey charlie sierra papa to runway zero six dynasty six one one
14:59:06	CAM1	一直走 (<i>straight forward</i>)
14:59:10	CAM2	transition is
14:59:11	CAM3	等一下客艙誰廣播 (<i>later who will make passenger announcement</i>)
14:59:12	FA	cabin attendant complete safety check
14:59:13	CAM1	一萬呎 (<i>ten thousand feet</i>)
14:59:15	CAM3	我來我來我來好了 (<i>let me do it I will do it</i>)
14:59:16	CAM3	等一下起飛前要廣播 (<i>later make the announcement before take off</i>)
14:59:18	CAM2	okay 起飛以前 (<i>before take off</i>)
14:59:20	CAM3	我們很少飛容易忘記了 (<i>we seldom fly easy to forget</i>)
14:59:22	CAM2	現在改成起飛前通通是 CM2 廣播 (<i>Now it changed to CM2 making all passenger announcement before take off</i>)
14:59:24	CAM3	是要是要廣播 (<i>yes have to announce</i>)
14:59:28	CAM3	上次就忘了一次 ---- 會忘 (<i>last time we forgot---forgot</i>)
14:59:35	CAM1	常飛又-- (<i>fly often yet--</i>)
14:59:36	CAM3	多少架 一二三四五第五架 (<i>how many planes one two three four five the fifth</i>)
14:59:39	CAM3	好 又有落地的 (<i>ok one landing again</i>)
14:59:41	CAM1	試飛的第二架--六么-- (<i>the second test flight--six one-</i>)
14:59:43	CAM3	又有落地的 一二三第四架 (<i>another landing again one two three the fourth</i>)
15:00:09	CAM3	(sound of cough)
15:00:19	CAM1	那個你這擺 arm (<i>that you set at arm</i>)
15:00:21	CAM2	哦對好 什麼位置 (<i>oh right ok at position</i>)
15:00:25	CAM2	聲音比較大一點 (<i>sounds a little louder</i>)
15:00:26	CAM1	沒關係 -- (<i>no problem</i>)

Local Time (radar time)	SOURCE	CONTENT
15:00:42	CI 666	(conversation with OPS)
15:00:43	FA	組員請就座 (<i>cabin crew please be seated</i>)
15:00:46	CAM2	whiskey Charlie
15:00:48	CAM	(sound similar to high low chime)
15:00:48	OPS	(conversation with CI 666)
15:00:50	CI 666	(conversation with OPS)
15:00:50	CAM	(sound similar to handset being removed from cradle)
15:00:52	CAM3	請講 (<i>go ahead</i>) thank you cabin ready
15:00:55	CAM	(sound similar to handset being returned to cradle)
15:00:56	OPS	(conversation with CI 666)
15:01:01	CAM	(unidentified sounds)
15:01:20	CAM	(sound similar to yawn)
15:01:25	CAM	(sound similar to cough)
15:01:33	CAM	(unidentified sounds)
15:01:38	GND	dynasty six one one contact tower one one eight point seven good day
15:01:42	RDO2	one eighteen seven dynasty six one one good day ma'am.
15:01:47	CAM	(sound similar to switch being rotated)
15:01:47	TWR	(conversation with BR 817)
15:01:52	BR 817	(conversation with TPE TWR)
15:01:56	RDO2	taipei good afternoon dynasty six one one on sierra papa
15:02:00	TWR	dynasty six one one taipei tower hold short runway zero six
15:02:03	RDO2	hold short runway zero six dynasty six one one
15:02:16	CAM	(unidentified sounds)
15:02:22	TWR	(conversation with GE 354)
15:02:28	GE 354	(conversation with TPE TWR)
15:02:42	TWR	(conversation with BR 817)
15:02:46	BR 817	(conversation with TPE TWR)
15:03:01	CI 196	(conversation with TPE TWR)
15:03:07	TWR	(conversation with CI 196)
15:03:18	CI 196	(conversation with TPE TWR)
15:03:28	CAM	--

Local Time (radar time)	SOURCE	CONTENT
15:03:32	CAM	(unidentified sounds)
15:03:43	CAM	(unidentified sounds)
15:04:12	CAM	(sound similar to seat motor)
15:04:21	TWR	(conversation with BR 2196)
15:04:26	BR 2196	(conversation with TPE TWR)
15:04:44	TWR	(conversation with GE 354)
15:04:50	GE 354	(conversation with TPE TWR)
15:04:52	CAM	(unidentified sounds)
15:05:09	TWR	(conversation with BR 2196)
15:05:17	BR 2196	(conversation with TPE TWR)
15:05:31	CX 466	(conversation with TPE TWR)
15:05:36	TWR	(conversation with CX 466)
15:05:46	CX 466	(conversation with TPE TWR)
15:05:49	TWR	dynasty six one one runway zero six taxi into position and hold
15:05:52	CAM	(sound similar to handset being removed from cradle)
15:05:52	CM3	cabin crew please be seated for takeoff
15:05:53	RDO2	into position hold runway zero six dynasty six one one
15:05:56	CAM	(sound similar to handset being returned to cradle)
15:05:58	CAM1	before takeoff items
15:05:59	CAM	(sound similar to seat motor)
15:06:00	FA	各位貴賓我們即將準備起飛請您確實的將安全帶繫好謝謝 ladies and gentlemen we are ready for take off please make sure that your seatbelt is securely fastened
15:06:06	CAM	(unidentified sounds)
15:06:08	CAM1	before takeoff check list
15:06:11	CAM3	okay cabin report received takeoff data
15:06:14	CAM1	confirmed
15:06:15	CAM2	confirmed
15:06:15	CAM3	confirmed ignition flight start transponder
15:06:18	CAM2	on
15:06:18	CAM3	fuel panel set two packs on
15:06:23	TWR	(conversation with BR 2196)

Local Time (radar time)	SOURCE	CONTENT
15:06:28	BR 2196	(conversation with TPE TWR)
15:06:24	CAM	(sound similar to cough)
15:06:40	CAM3	body gear steering
15:06:40	CAM	(sound similar to switch movement)
15:06:41	CAM1	disarm
15:06:42	CAM3	annunciator lights
15:06:43	CAM1	check
15:06:44	CAM2	check
15:06:44	CAM3	check
15:06:45	CAM3	runway identification
15:06:46	CAM1	identification check
15:06:47	CAM3	check
15:06:47	CAM2	check
15:06:48	CAM3	takeoff clearance standby
15:06:51	CAM	(unidentified sounds)
15:06:53	CAM	(sounds similar to seat motor)
15:07:10	TWR	dynasty six one one runway zero six wind zero five zero at niner cleared for takeoff
15:07:16	RDO1	cleared for takeoff dynasty six one one
15:07:18	CAM3	okay received takeoff clearance
15:07:20	CAM1	takeoff
15:07:21	CAM3	takeoff checklist complete
15:07:23	CAM	(sound similar to engine noise increasing)
15:07:34	CAM3	takeoff thrust set
15:07:35	CAM1	check
15:07:44	CAM1	eighty
15:07:45	CAM2	check
15:07:52	CAM1	vee one
15:07:56	CAM1	rotate
15:07:57	CAM	(unidentified sounds)
15:08:01	CAM	(sound similar to landing gear unlock retract solenoid)
15:08:02	TWR	(conversation with CX 466)

Local Time (radar time)	SOURCE	CONTENT
15:08:07	CX 466	(conversation with TPE TWR)
15:08:03	CAM1	positive rate
15:08:04	CAM2	gears up
15:08:06	CAM	(sound similar to gear lever movement)
15:08:07	CAM2	ias
15:08:08	CAM1	ias
15:08:17	CAM	(unidentified sound)
15:08:19	TWR	(conversation with CI 196)
15:08:25	CI 196	(conversation with TPE TWR)
15:08:32	TWR	dynasty six one one contact taipei approach one two five point one good day
15:08:36	RDO1	good day
15:08:37	APP	(conversation with CI 682)
15:08:41	CI 682	(conversation with TPE APP)
15:08:43	APP	(conversation with B7 303)
15:08:46	CAM2	climb thrust vertical speed one thousand
15:08:49	B7 303	(conversation with TPE APP)
15:08:51	APP	(conversation with B7 303)
15:08:53	RDO1	taipei approach dynasty six one one airborne passing one thousand six hundred
15:08:57	APP	dynasty six one one taipei approach radar contact climb and maintain flight level two six zero cancel flight level two zero zero restriction
15:09:04	RDO1	reclear two six zero cancel two zero zero restriction dynasty six one one
15:09:07	CAM3	climb power set
15:09:09	APP	(conversation with 5X 6884)
15:09:09	CAM2	okay flap five flap ten
15:09:11	CAM	(sound similar to flap lever movement)
15:09:12	5X 6884	(conversation with TPE APP)
15:09:17	CAM3	ten ten
15:09:18	CAM2	flap five
15:09:19	CAM	(sound similar to seat motor)

Local Time (radar time)	SOURCE	CONTENT
15:09:21	CAM1	five
15:09:21	CAM	(sound similar to flap lever movement)
15:09:23	CAM2	左轉兩三五 (<i>left turn two three five</i>)
15:09:26	CAM3	five five
15:09:34	CAM2	flap one
15:09:36	APP	(conversation with EF 032)
15:09:36	CAM	(sound similar to flap lever movement)
15:09:40	EF 032	(conversation with TPE APP)
15:09:49	APP	(conversation with CI 321)
15:10:00	CI 321	(conversation with TPE APP)
15:10:07	APP	(conversation with CI 652)
15:10:10	CI 652	(conversation with TPE APP)
15:10:10	CAM3	one one green
15:10:10	CAM1	one one green
15:10:11	CAM2	okay flap up
15:10:13	CAM	(sound similar to flap lever movement)
15:10:19	APP	(conversation with EF 032)
15:10:21	CAM3	up up light out
15:10:23	EF 032	(conversation with TPE APP)
15:10:30	CAM3	(sound similar to seat motor)
15:10:34	APP	dynasty six one one proceed direct to chali resume own navigation
15:10:38	RDO1	proceed direct chali resume own navigation dynasty six one one
15:10:42	CAM2	第二點 (<i>second waypoint</i>)
15:10:47	CAM	--
15:10:49	APP	(conversation with CI 652)
15:10:51	CAM2	ias
15:10:53	CI 652	(conversation with TPE APP)
15:10:57	CAM	(sound similar to seat motor)
15:11:04	CI 321	(conversation with TPE APP)
15:11:08	APP	(conversation with CI 321)
15:11:11	CI 321	(conversation with TPE APP)

Local Time (radar time)	SOURCE	CONTENT
15:11:13	APP	(conversation with EF 032)
15:11:16	CAM2	autopilot b engage
15:11:19	CAM	(sound similar to autopilot engage switch)
15:11:20	EF 032	(conversation with TPE APP)
15:11:22	CAM3	我們起飛寫幾分啊 (<i>when did we take off</i>)
15:11:24	CAM1	那時忘了記洞七是不是 (<i>I forgot to write down the time, zero seven was it</i>)
15:11:27	CAM2	洞八 (<i>zero eight</i>)
15:11:30	APP	(conversation with EF 032)
15:11:31	CAM2	標準是洞八 (<i>that should be zero eight</i>)
15:11:32	APP	(conversation with BR 2196)
15:11:36	CAM	(unidentified sounds)
15:11:37	BR 2196	(conversation with TPE APP)
15:11:40	APP	(conversation with BR 2196)
15:11:52	CM3	cabin crew service check please
15:11:54	CAM	(sound similar to handset being returned to cradle)
15:12:01	CAM3	flight operation --
15:12:03	RDO3	taipei dynasty operation six one one
15:12:08	CAM	(sound similar to cough)
15:12:11	OPS	-- go ahead
15:12:12	RDO3	six one one taipei zero six five zero diagonal zero eight hongkong zero eight two eight
15:12:15	APP	(conversation with CI 682)
15:12:18	OPS	six one one roger zero six five zero diagonal zero eight hongkong zero eight two eight nice flight
15:12:25	CM3	謝謝 (<i>thanks you</i>)
15:12:28	CAM2	報一下 (<i>announce</i>) cabin service check
15:12:30	CI 682	(conversation with TPE APP)
15:12:30	CAM3	已經報過了 (<i>I did</i>)
15:12:31	CAM2	一萬呎 (<i>ten thousand feet</i>) check 過了 (<i>already</i>)
15:12:39	CAM2	one zero one tree
15:12:47	APP	(conversation with CI 652)

Local Time (radar time)	SOURCE	CONTENT
15:12:51	CI 652	(conversation with TPE APP)
15:12:55	CAM	(sound similar to autopilot mode selection movement)
15:12:55	CAM2	speed
15:12:57	SQ984	(conversation with TPE APP)
15:13:01	APP	(conversation with SQ984)
15:13:13	SQ984	(conversation with TPE APP)
15:13:28	BR 1852	(conversation with TPE APP)
15:13:35	APP	(conversation with BR 1852)
15:13:46	BR 1852	(conversation with TPE APP)
15:14:00	ALL_TK	(no signal for 0.3 seconds)
15:14:02	CI 196	(conversation with OPS)
15:14:07	CAM	(unidentified sounds)
15:14:07	OPS	(conversation with CI 196)
15:14:09	CI 196	(conversation with OPS)
15:14:11	CI 682	(conversation with TPE APP)
15:14:15	APP	(conversation with CI 682)
15:14:19	CI 682	(conversation with TPE APP)
15:14:21	APP	(conversation with CI 682)
15:14:26	PRAM	各位貴賓請繫安全帶的指示燈已經熄滅了 (<i>ladies and gentlemen the seat belt sign has been turned off</i>)
15:14:34	CAM	(sound similar to seat motor)
15:14:52	APP	(conversation with EF 032)
15:15:02	EF 032	(conversation with TPE APP)
15:15:19	APP	(conversation with SQ984)
15:15:23	SQ984	(conversation with TPE APP)
15:15:27	APP	(conversation with BR 1852)
15:15:30	BR 1852	(conversation with TPE APP)
15:15:41	VOLMET	(hongkong weather report)
15:15:46	APP	(conversation with CI 652)
15:15:57	CI 652	(conversation with TPE APP)
15:16:06	APP	dynasty six one one contact taipei control one two six point seven
15:16:10	RDO1	one two six seven dynasty six one one

Local Time (radar time)	SOURCE	CONTENT
15:16:18	RDO1	taipei control dynasty six one one passing level one eight seven continue two six zero
15:16:24	ACC	dynasty six one one taipei control ident climb and maintain flight level tree five zero from chali direct kadlo
15:16:30	CAM	(sound similar to seat motor)
15:16:31	RDO1	from chali direct to kadlo recleared tree five zero dynasty six one one
15:16:35	CAM3	香港 (<i>hong kong</i>)
15:16:37	CAM2	thank you
15:16:38	CAM1	-- 下一點 (<i>next waypoint</i>) -- kadlo --
15:16:41	CAM2	第三點我們改一下 (<i>we change the third waypoint</i>)
15:16:42	CAM3	-- 兩五跑道 (<i>runway two five</i>)
15:16:43	CAM2	第三點改為 (<i>the third waypoint changed to</i>) kadlo
15:16:55	CAM	-- 經過 (<i>via</i>) --
15:16:58	CAM1	三萬五 (<i>thirty-five thousand</i>)
15:16:58	CAM2	二二五七三 (<i>two two five seven three</i>)
15:17:05	CAM	么么八三二五 (<i>one one eight three two five</i>)
15:17:11	CAM2	么么八三二五 (<i>one one eight three two five</i>)
15:17:16	CAM	Okay
15:17:22	CAM1	兩八洞洞八 兩五跑道 (<i>two eight zero zero eight runway two five</i>)
15:17:24	CAM2	兩五跑道 (<i>runway two five</i>)
15:17:24	CAM	--
15:17:25	CAM3	兩五跑道這上面都有 (<i>runway two five is shown here</i>)
15:17:28	CAM2	多少度 溫度 (<i>how many degrees in temperature</i>)
15:17:30	CAM3	溫度二十八 (<i>temperature twenty-eight</i>)
15:17:30	CAM2	二十八謝謝 (<i>twenty-eight thank you</i>)
15:17:31	CAM	么洞洞 -- (<i>one zero zero</i>)
15:17:36	CAM1	thank you
15:17:55	CAM	(sound similar to singing)
15:18:28	CAM	(unidentified sounds)
15:18:35	CAM	(unidentified sounds)
15:18:58	CAM1	-- 要 direct 才對 (<i>direct is correct</i>)

Local Time (radar time)	SOURCE	CONTENT
15:19:01	CAM	--
15:19:02	CAM2	-- 就這樣子啦--那就是 chali 到--(<i>that's it that's from chali to</i>)
15:19:06	CAM	(unidentified sound)
15:19:07	CAM2	反過來我看少五哩--(<i>from the other end I see five nautical miles short</i>)
15:19:16	CAM	(sound similar to singing)
15:19:27	CAM	(unidentified sounds)
15:19:50	CAM	(sound similar to singing)
15:20:18	EF 126	(conversation with TPE ACC)
15:20:24	ACC	(conversation with EF 126)
15:20:27	EF 126	(conversation with TPE ACC)
15:20:31	B7 608	(conversation with TPE ACC)
15:20:34	CAM	(unidentified sounds)
15:20:35	ACC	(conversation with B7 608)
15:20:38	B7 608	(conversation with TPE ACC)
15:20:40	ACC	(conversation with B7 608)
15:20:53	CAM	(sound similar to signal interference)
15:21:03	CAM	(sound similar to signal interference)
15:21:04	CAM	(sound similar to signal interference)
15:21:07	CAM	(sound similar to signal interference)
15:21:07	CAM	(sound similar to signal interference)
15:21:11	CAM	(sound similar to signal interference)
15:21:14	CAM	(sound similar to signal interference)
15:21:50	CAM3	okay its okay
15:21:51	CAM1	thank you
15:21:51	TRACK2	(unidentified sound similar to squelch break)
15:21:54	TRACK2	(unidentified sound similar to squelch break)
15:22:00	TRACK2	(unidentified sound similar to squelch break)
15:22:06	TRACK2	(unidentified sound similar to squelch break)
15:22:10	TRACK2	(unidentified sound similar to squelch break)
15:22:13	TRACK2	(unidentified sound similar to squelch break)
15:22:17	GE 536	(conversation with TPE ACC)

Local Time (radar time)	SOURCE	CONTENT
15:22:21	MFXXX	(conversation with another unknown flight until 00:27:20)
15:22:22	CAM	(unidentified sound)
15:22:24	ACC	(conversation with GE 536)
15:22:29	GE 536	(conversation with TPE ACC)
15:22:43	CAM2	兩五 -- (two five)
15:23:03	CAM2	兩 -- 謝謝 (two-- thanks)
15:23:07	CAM1	thank you
15:23:08	CAM	(unidentified sound)
15:23:14	CAM2	收到 atis 以後再來調一點 大概就 direct 第八點第七點就不用如果是兩五的話 (after receiving atis then adjust most likely direct to waypoint eight waypoint seven no need if using two five)
15:23:20	ACC	(conversation with B7 608)
15:23:24	B7 608	(conversation with TPE ACC)
15:23:27	ACC	(conversation with BR 817)
15:23:31	BR 817	(conversation with TPE ACC)
15:23:34	ACC	(conversation with TG 7078)
15:23:40	TG 7078	(conversation with TPE ACC)
15:23:42	ACC	(conversation with AE271)
15:23:47	AE271	(conversation with TPE ACC)
15:24:10	CAM	(unidentified sound)
15:24:52	ACC	(conversation with B7 608)
15:24:55	B7 608	(conversation with TPE ACC)
15:24:56	CAM	(sound similar to yawn)
15:26:16	ACC	(conversation with EF 126)
15:26:21	EF 126	(conversation with TPE ACC)
15:26:24	ACC	(conversation with EF 126)
15:26:25	CAM1	two thousand
15:26:27	EF 126	(conversation with TPE ACC)
15:26:32	XX 057	(conversation with XX FOC)
15:26:36	ACC	(conversation with EF 126)
15:26:39	EF 126	(conversation with TPE ACC)

Local Time (radar time)	SOURCE	CONTENT
15:26:40	XX FOC	(conversation with XX 057)
15:26:43	XX 057	(conversation with XX FOC)
15:26:50	XX FOC	(conversation with XX 057)
15:26:54	XX 057	(conversation with XX FOC)
15:27:00	XX FOC	(conversation with XX 057)
15:27:06	CX 418	(conversation with TPE ACC)
15:27:09	ACC	(conversation with CX 418)
15:27:16	CAM	(unidentified sounds)
15:27:33	CAM	(unidentified sound)
15:27:37	ACC	(conversation with EF 126)
15:27:39	CAM	(sound similar to altitude alert)
15:27:40	CAM	(unidentified sounds)
15:27:40	EF 126	(conversation with TPE ACC)
15:27:46	CAM	(unidentified sound)
15:28:03	CAM	(unidentified sound, end of CVR)

附錄 10 CI611 座艙語音紀錄器聲紋

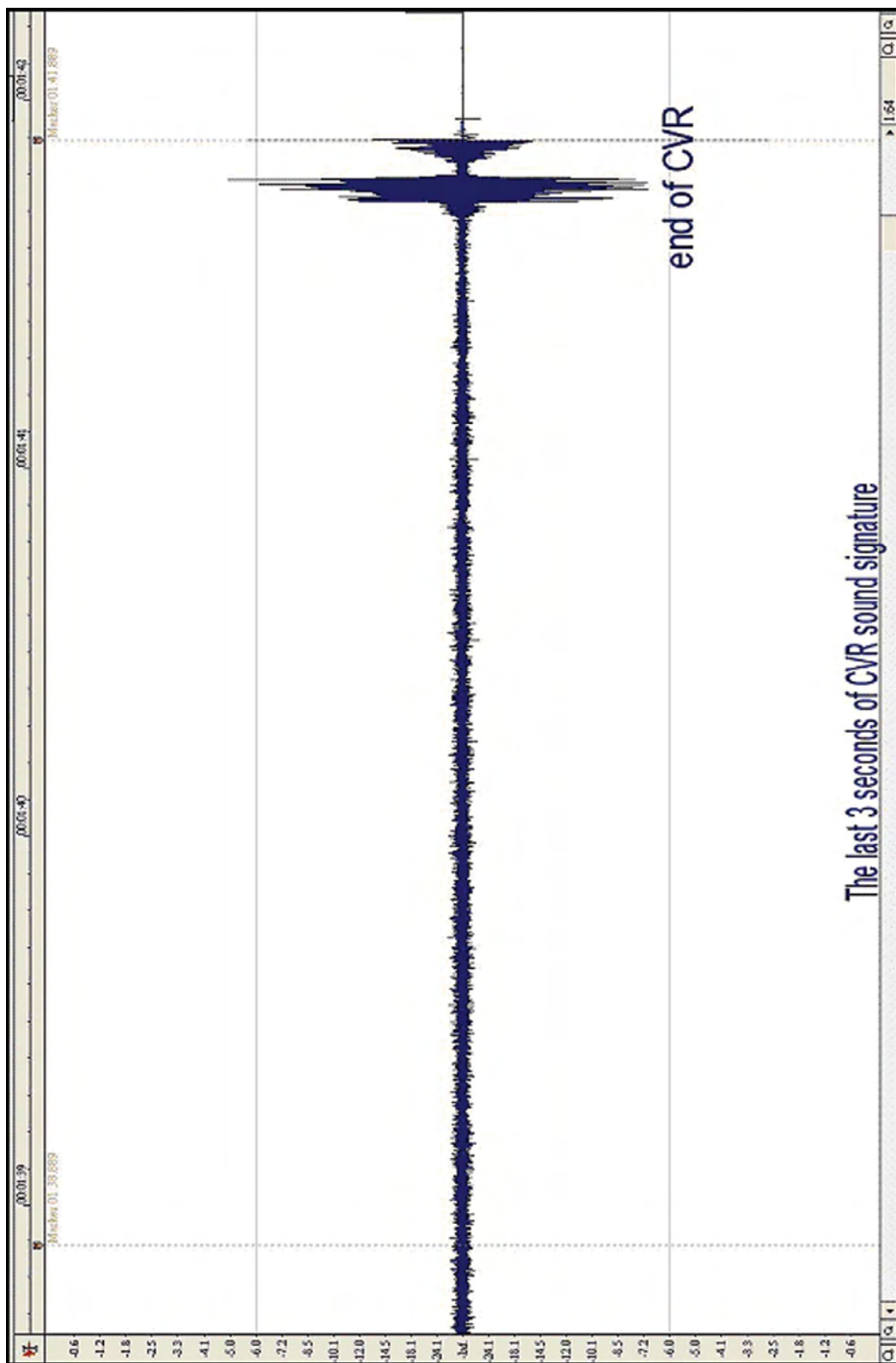

此頁空白

附錄 11 CI611 飛航資料紀錄器參數表

No.	Parameter Name	Resolution	Word Location(s)
1	Time	1/768 sec	1
2	Pressure Altitude Course	132.17 Ft	23 (S/F 1)
	Pressure Altitude Fine	4.88 Ft	5
3	Airspeed (IAS)	0.56 Knots	19
4	Vertical acceleration	0.00916 G	13, 29, 45, 61
5	Longitudinal acceleration	0.00195 G	2, 18, 34, 50
6	Lateral acceleration	0.00195 G	15, 31, 47, 63
7	Magnetic Heading	0.352 deg	3
8	Pitch	0.352 deg	51
9	Roll	0.352 deg	17
10	Control Column Position (CCP)	0.031 deg	41
11	Control Wheel Position (CWP)	0.797 deg	9
12	Engine Pressure Ratio (EPR)		
	EPR No.1	0.01 %	33 (S/F 1)
	EPR No.2	0.01 %	33 (S/F 2)
	EPR No.3	0.01 %	33 (S/F 3)
	EPR No.4	0.01 %	33 (S/F 4)
13	Flap position – L.E. (Extended R set 2)		
	Flap L.E. Extended R#1	Discrete value EXT= Extended NOT= Not Extended	11 (bit 1)
	Flap L.E. Extended R#2		28 (bit 1)
	Flap L.E. Extended R#3		43 (bit 1)
	Flap L.E. Extended R#4		59 (bit 1)
	Flap L.E. Extended L#1		63 (bit 1)
	Flap L.E. Extended L#2		29 (bit 1)
	Flap L.E. Extended L#3		8 (bit 1)
Flap L.E. Extended 2#4	17 (bit 1)		
14	Flap Position – T.E. (R. Inboard)	Non-Linear Parameter	39 (S/F 1,3)
15	Horizontal Stabilizer Position (Pitch Trim)	0.044 deg	55 (S/F 1,3)
16	Rudder Pedal Position	0.127 deg	27,59

No.	Parameter Name	Resolution	Word Location(s)
17	Thrust Reverser Position T/R in-transit ENG 1 T/R in-transit ENG 2 T/R in-transit ENG 3 T/R in-transit ENG 4 T/R Unlock ENG 1 T/R Unlock ENG 2 T/R Unlock ENG 3 T/R Unlock ENG 4	Discrete value Transit = Transit Not = Not Transit Unlock= Unlock Not = Not Unlock	22 51 45 41 7 (S/F 1) 7 (S/F 2) 7 (S/F 3) 7 (S/F 4)
18	VHF 1, 2,3 Transmitter Keying	Discrete value KEY= Keyed OFF= No Keyed	9
19	HF 1, 2 Transmitter Keying	Discrete value KEY= Keyed OFF= No Keyed	15
20	Angle of Airflow	0.352 deg	11 ,43

附錄 12 CI611 飛航資料紀錄器參數圖表

Figure 1	FDR data plots of CI611 (entire flight, digital parameters)
Figure 2	FDR data plots of CI611 (entire flight, with discrete signals)
Figure 3	FDR data plots of CI611 (pre-flight section with CVR transcripts)
Figure 4	FDR data plots of CI611 (Taxi section with CVR transcripts)
Figure 5	FDR data plots of CI611 (takeoff section with CVR transcripts)
Figure 6	FDR data plots of CI611 (pass through 18,000 ft with CVR transcripts)
Figure 7	FDR data plots of CI611 (during 22,000 ft and 28,000ft, with CVR unidentified sound and interference signal)
Figure 8	FDR data plots of CI611 (during 25,000 ft and 28,000ft, with CVR signal interference)
Figure 9	DR data plots of CI611 (during 27,000 ft and 32,000ft, with CVR squelch signal)
Figure 10	FDR data plots of CI611 (during 32,000 ft and 35,000ft, with CVR unidentified sound)
Figure 11	FDR data plots of CI611 (last 30 seconds, with CVR unidentified sound)

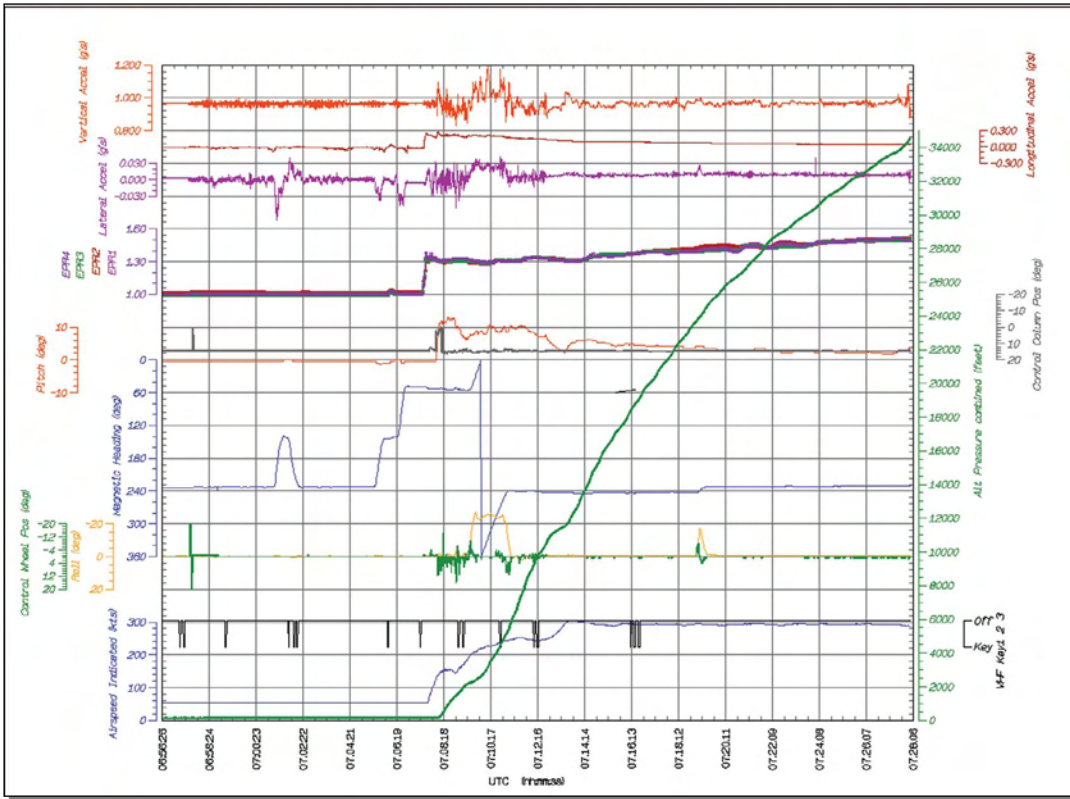

Figure 1 FDR data plots of CI611 (entire flight, digital parameters)

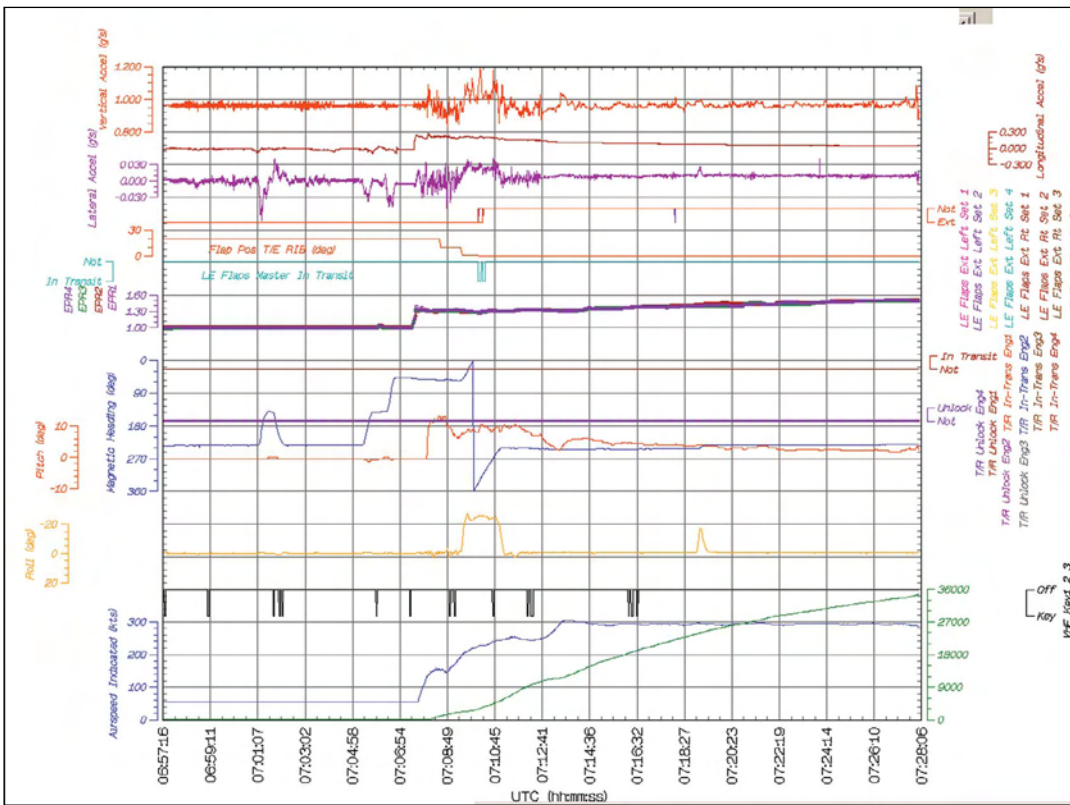

Figure 2 FDR data plots of CI611 (entire flight, with discrete signals)

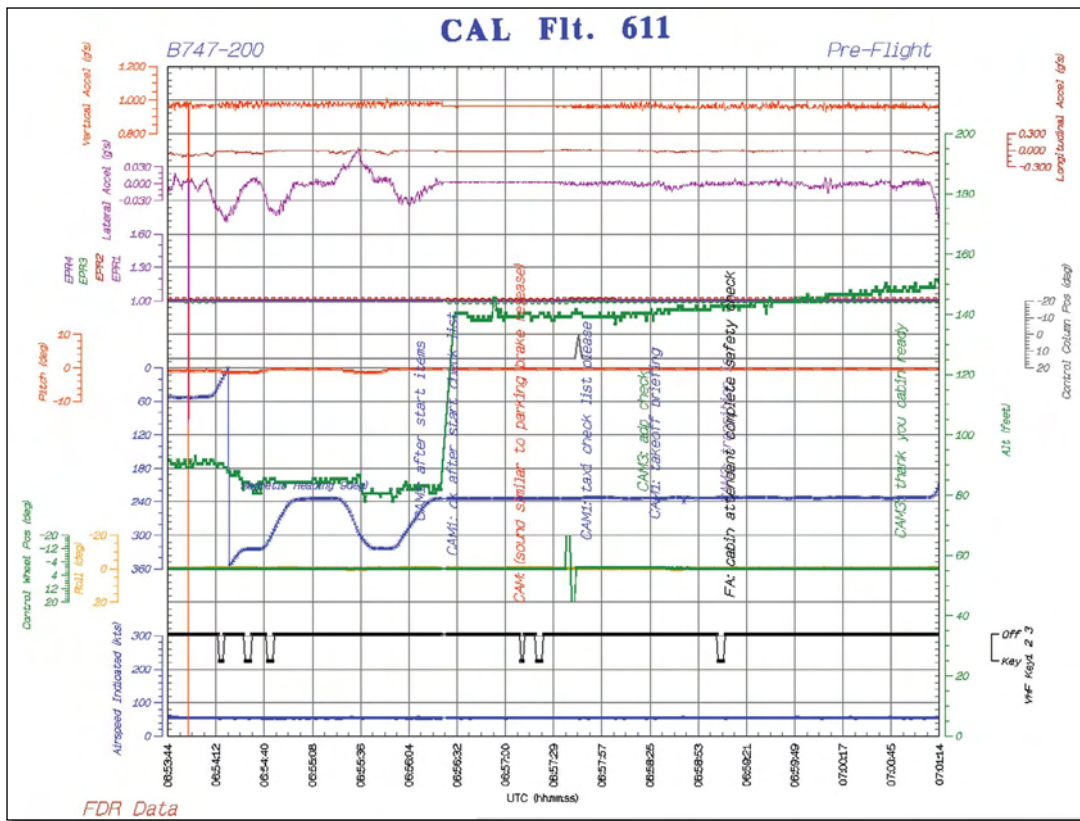

Figure 3 FDR data plots of CI611 (pre-flight section with CVR transcripts)

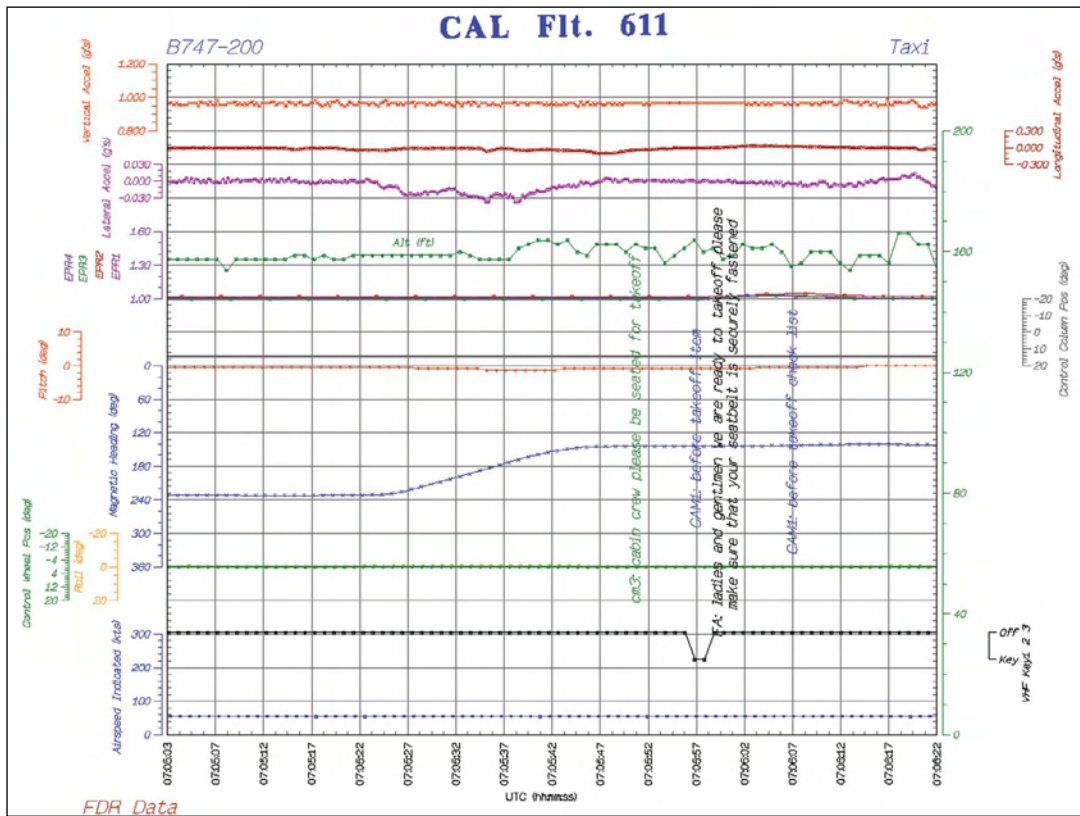

Figure 4 FDR data plots of CI611 (Taxi section with CVR transcripts)

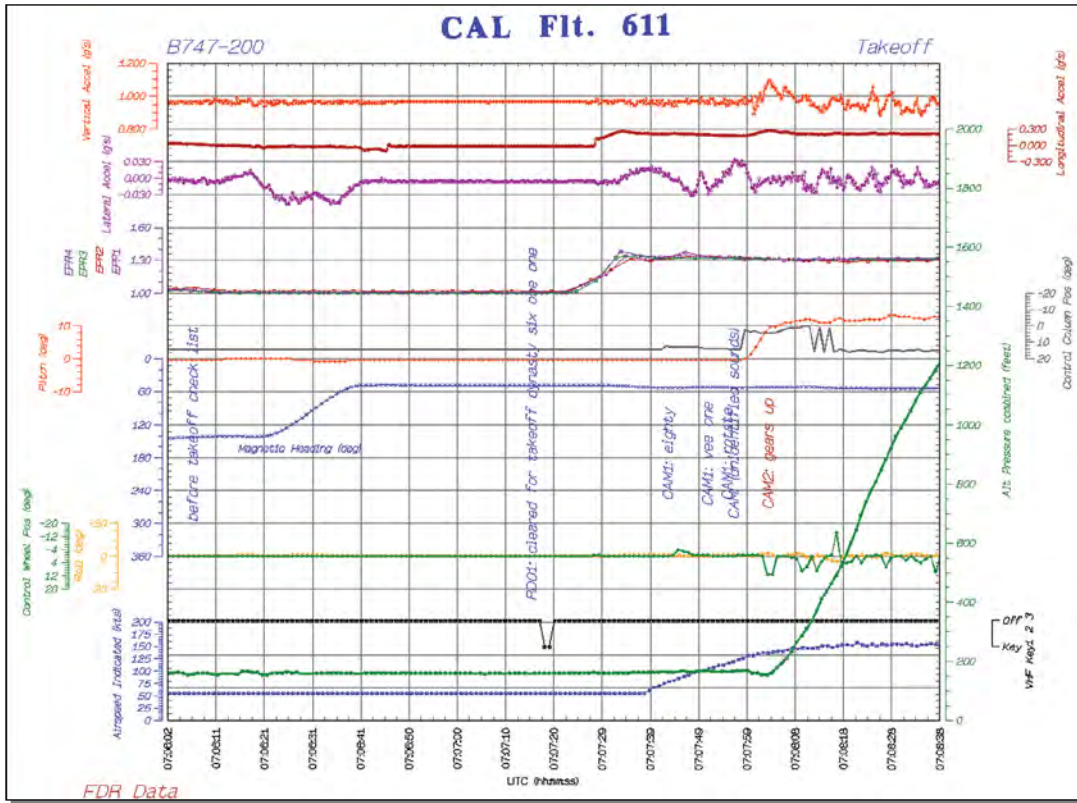

Figure 5 FDR data plots of CI611 (takeoff section with CVR transcripts)

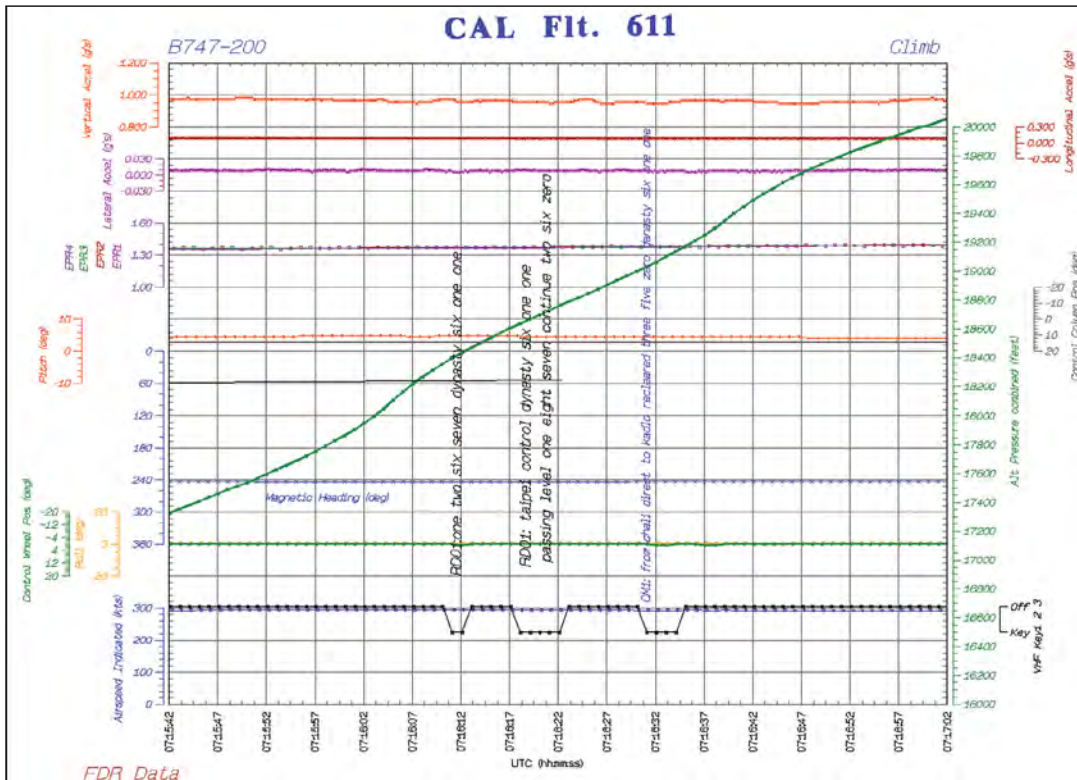

Figure 6 FDR data plots of CI611 (pass though 18,000 ft with CVR transcripts)

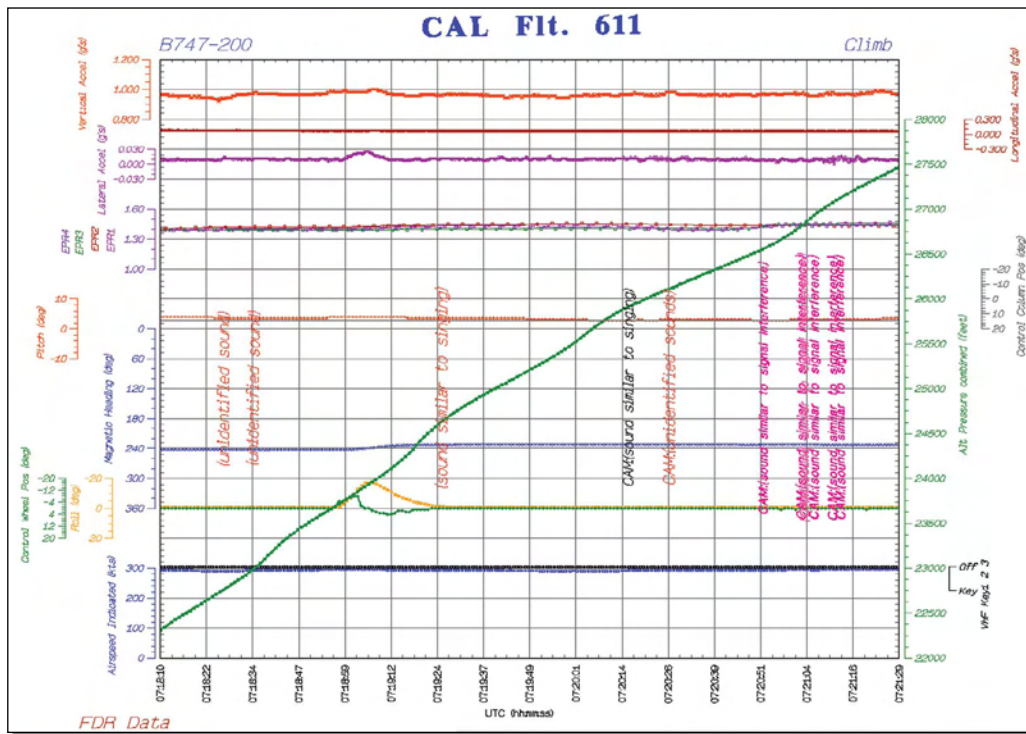

Figure 7 FDR data plots of CI611 (during 22,000 ft and 28,000ft, with CVR unidentified sound and interference signal)

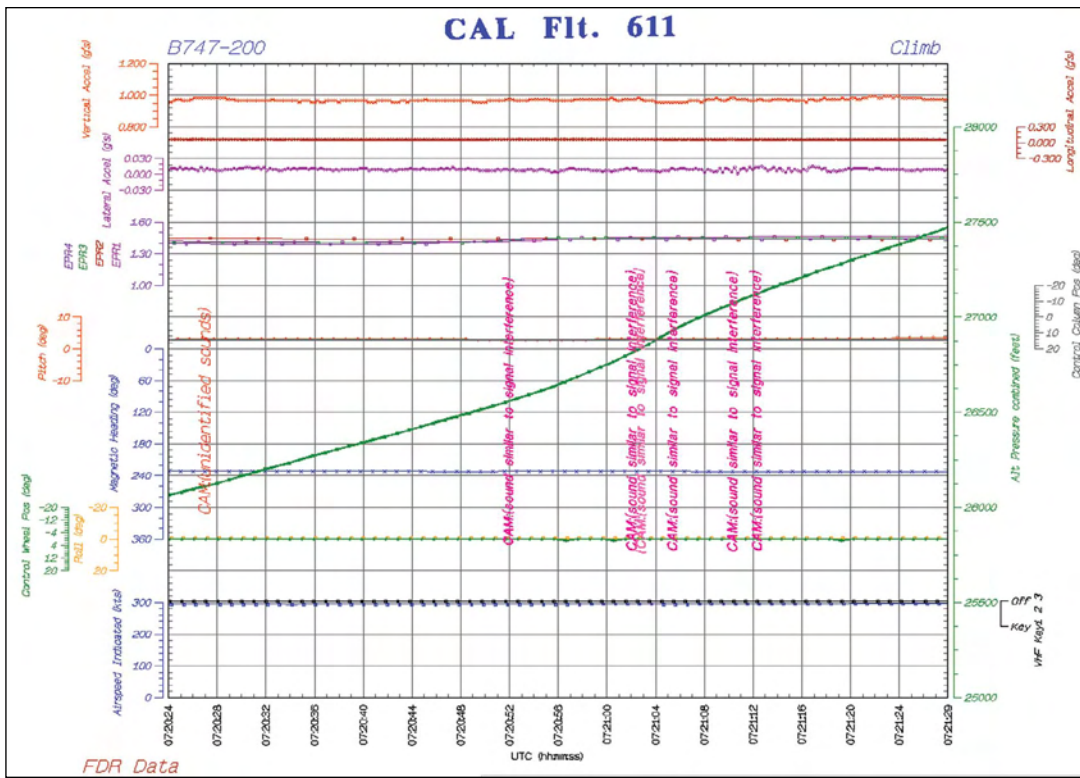

Figure 8 FDR data plots of CI611 (during 25,000 ft and 28,000ft, with CVR signal interference)

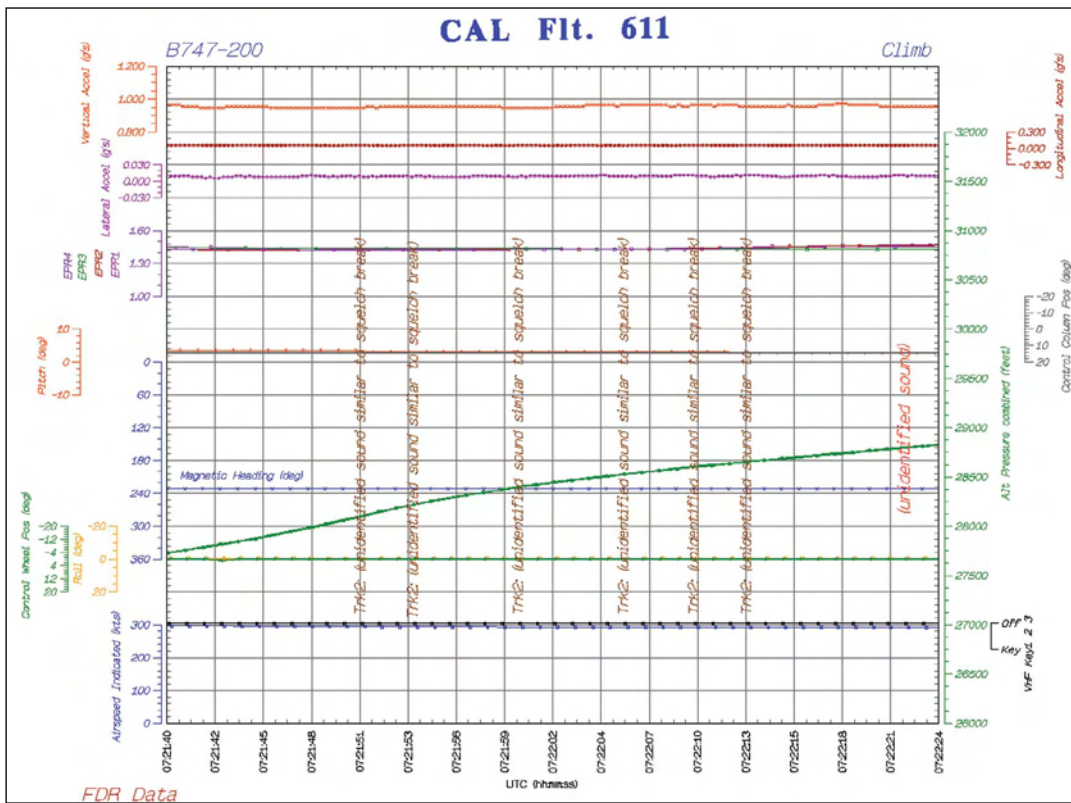

Figure 9 FDR data plots of CI611 (during 27,000 ft and 32,000ft, with CVR squelch signal)

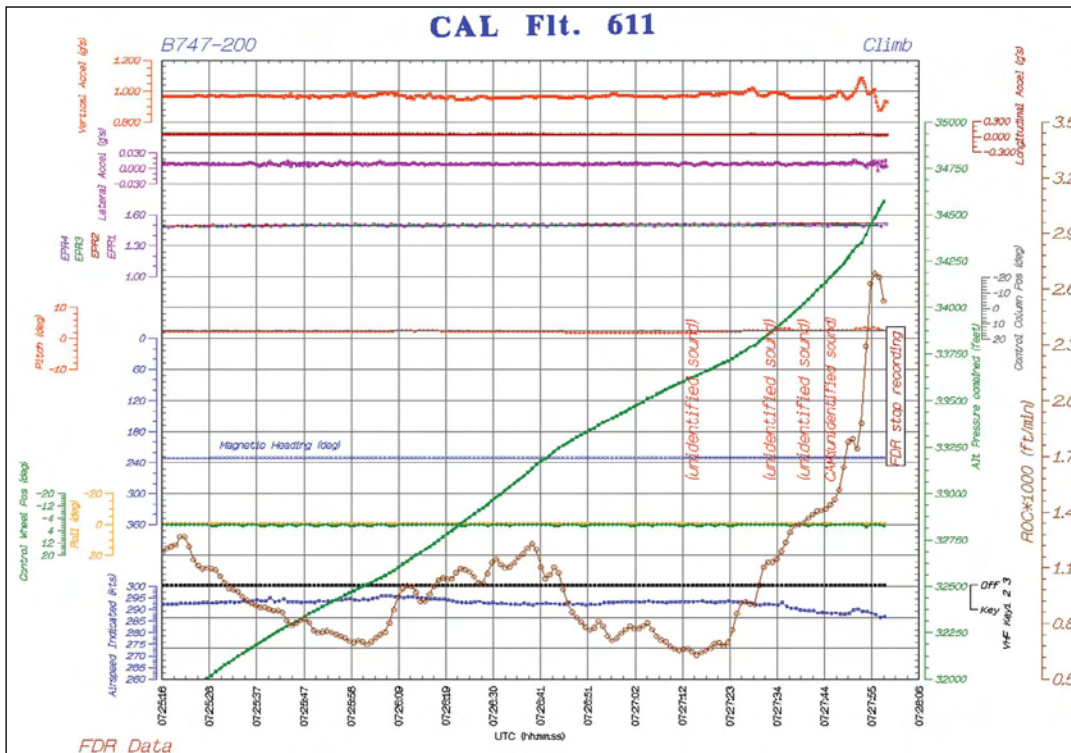

Figure 10 FDR data plots of CI611 (during 32,000 ft and 35,000ft, with CVR unidentified sound)

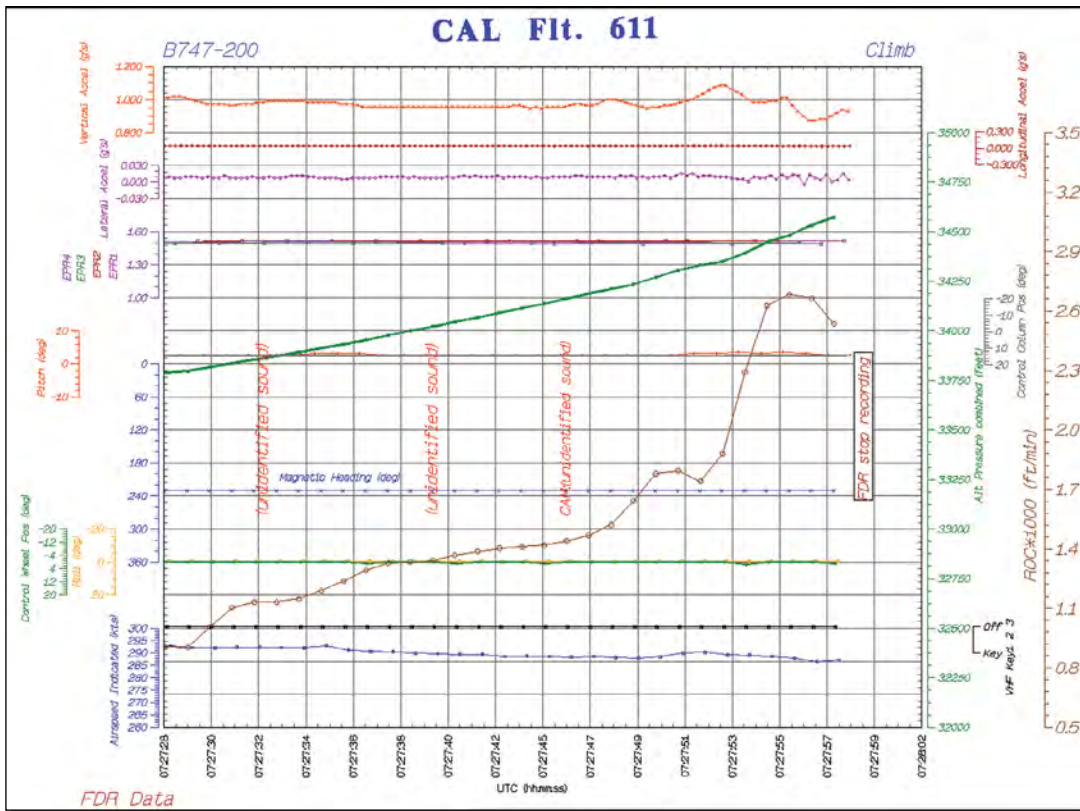

Figure 11 FDR data plots of CI611 (last 30 seconds, with CVR unidentified sound)

此頁空白

附錄 13 飛安會 CI611 殘骸資料庫

Tag No.	Date	Latitude	Longitude	Zone	Description	ATA	Major Zone	Station From	Station To	Section From/To	Stringer From/To	Length	Width	Height	Remarks
1	N/A	N/A	N/A	N/A	Composite Fixed Panel	57	500/600	N/A	N/A	N/A	N/A	18.0"	35.0"	N/A	Fractured
2	N/A	N/A	N/A	N/A	Composite Panel, Steric "Aileron" Sidewall Insulation Blanket	57	500/600	N/A	N/A	N/A	N/A	14.0"	25.0"	N/A	Fractured
3	N/A	N/A	N/A	N/A	Passenger Hand Bag (FIONA)	25	100/200	N/A	N/A	N/A	N/A	60.0"	26.0"	N/A	Smell Fuel Packaged, Non-aircraft Parts (Return to Aviation Police Bureau)
4	N/A	N/A	N/A	N/A	Infant Life Vest, Qty: 4 EA	0	N/A	N/A	N/A	N/A	N/A	10.0"	18.0"	N/A	One Integrated Piece
5	N/A	N/A	N/A	N/A	Jump Seat Back Frame	25	200	N/A	N/A	N/A	N/A	60.0"	36.0"	N/A	Deformed and 2EA Punch Holes
6	N/A	N/A	N/A	N/A	RH FWD Side Panel, Galley G4	25	200	N/A	N/A	N/A	N/A	36.0"	96.0"	N/A	Fractured Piece Panel with Deform and Cracks, Bell Linkage Broken
7	N/A	N/A	N/A	N/A	LH IB T/E Fore flap, P/N: 65B39011-17, S/N: 000446	27	500	N/A	N/A	N/A	N/A	N/A	N/A	N/A	Peeled off
8	N/A	N/A	N/A	N/A	LH IB T/E Fore flap T/E wedge strip with Bulkhead (P/N: 65B51523-20)	27	500	N/A	N/A	N/A	N/A	20.0"	1.0"	0.3"	Fractured and Bent
9	N/A	N/A	N/A	N/A	Attendant Seat Frame, Door #1	25	200	N/A	N/A	N/A	N/A	N/A	N/A	N/A	N/A
10	N/A	N/A	N/A	N/A	Wheel, Cargo PDU	25	200	N/A	N/A	N/A	N/A	72.0"	42.5"	19.0"	N/A
11	N/A	N/A	N/A	N/A	1/2 Stowage Bin	25	200	N/A	N/A	N/A	N/A	N/A	N/A	N/A	N/A
12	N/A	N/A	N/A	N/A	RH Escape Slide	25	200	N/A	N/A	N/A	N/A	31.5"	13.0"	N/A	Fractured
13	N/A	N/A	N/A	N/A	Composite Fairing (Panel P/N: 65B03107-011, Angle: 65B03280-501)	25	200	N/A	N/A	N/A	N/A	N/A	N/A	N/A	Fractured
14	N/A	N/A	N/A	N/A	Composite Door (P/N: 65B67588-33, 65B67589-17)	N/A	N/A	N/A	N/A	N/A	N/A	38.5"	18.0"	N/A	N/A
15	N/A	N/A	N/A	N/A	Composite Shield with Closet Lights Partition	25	200	N/A	N/A	N/A	N/A	2.5"	18.0"	N/A	Fractured
16	N/A	N/A	N/A	N/A	Stowage Bin	25	200	N/A	N/A	N/A	N/A	38.0"	42.0"	N/A	Fractured
17	N/A	N/A	N/A	N/A	Support Beam with Inbd Spoiler (Actuator P/N: 60B60085-5)	25	200	N/A	N/A	N/A	N/A	38.0"	18.5"	N/A	Fractured
18	N/A	N/A	N/A	N/A	Vertical Fin (P/N: 65B03234 - 65B03236-015, -016)	57	500/600	N/A	N/A	N/A	N/A	122.0"	61.0"	N/A	Spar Fractured and Panel Cracked and Delaminated
19	N/A	N/A	N/A	N/A	Vertical Fin (P/N: 65B03237 - 65B03239-015, -016)	55	300	N/A	N/A	N/A	N/A	88.0"	66.0"	N/A	Fractured and Punched Many Places
20	N/A	N/A	N/A	N/A	LH Fan Cowl, #4 Engine	55	300	N/A	N/A	N/A	N/A	71.0"	82.0"	N/A	Fractured and Punched Many Places
21	N/A	N/A	N/A	N/A	Stowage Bin (Row 38-41 H/J)	54	400	N/A	N/A	N/A	N/A	141.0"	35.0"	N/A	Cracked and Bent
22	N/A	N/A	N/A	N/A	LH OB Aileron (P/N: 65B02160-901)	25	200	N/A	N/A	N/A	N/A	139.0"	32.0"	24.0"	N/A
23	N/A	N/A	N/A	N/A	Duct (P/N: BAC27EAC-68)	57	500	N/A	N/A	N/A	N/A	36.0"	18.0"	N/A	Piece of Part
24	N/A	N/A	N/A	N/A	RH Wing T/E Flap Movable Fairing Aft Part	36	200	N/A	N/A	N/A	N/A	18.0"	N/A	N/A	Cracked and Broken
25	N/A	N/A	N/A	N/A	RH Wing L/E Fairing (611FB)	57	600	N/A	N/A	N/A	N/A	61.0"	31.0"	N/A	Fairing and Linkages Fractured
26	N/A	N/A	N/A	N/A	RH OB Wing Gear Door (744AB)	57	600	N/A	N/A	N/A	N/A	14.5"	16.5"	N/A	Fractured
27	N/A	N/A	N/A	N/A	Floor Panel (B24/B28)	57	600	N/A	N/A	N/A	N/A	31.0"	25.0"	N/A	Fractured
28	N/A	N/A	N/A	N/A	Floor Panel Section	25	200	N/A	N/A	N/A	N/A	120.0"	38.0"	N/A	Torsion
29	N/A	N/A	N/A	N/A	Trey Table	25	200	N/A	N/A	N/A	N/A	19.0"	20.0"	N/A	N/A
30	N/A	N/A	N/A	N/A	Trey Table	25	200	N/A	N/A	N/A	N/A	N/A	N/A	N/A	N/A
31	N/A	N/A	N/A	N/A	Galley Chiller Duct	25	200	N/A	N/A	N/A	N/A	37.0"	16.0"	N/A	N/A
32	N/A	N/A	N/A	N/A	Baby Bassinette	25	200	N/A	N/A	N/A	N/A	N/A	N/A	N/A	N/A
33	N/A	N/A	N/A	N/A	Galley Stowage Cart Top	25	200	N/A	N/A	N/A	N/A	49.0"	31.0"	N/A	N/A
34	N/A	N/A	N/A	N/A	Duct with Insulation (P/N: 65B4777)	25	200	N/A	N/A	N/A	N/A	27.0"	N/A	N/A	N/A
35	N/A	N/A	N/A	N/A	Body Fairing Panel with Frames	53	100	N/A	N/A	N/A	N/A	39.0"	87.0"	N/A	N/A
36	N/A	N/A	N/A	N/A	Tire/Wheel	32	700	N/A	N/A	N/A	N/A	N/A	N/A	N/A	N/A
37	N/A	N/A	N/A	N/A	IB Spoiler (including spoiler control package)	57	500/600	N/A	N/A	N/A	N/A	70.0"	91.0"	6.5"	N/A
38	N/A	N/A	N/A	N/A	Panel-Bin	25	200	N/A	N/A	N/A	N/A	N/A	N/A	N/A	N/A
39	N/A	N/A	N/A	N/A	Duct-Composite	36	200	N/A	N/A	N/A	N/A	N/A	N/A	N/A	Fracture
40	N/A	N/A	N/A	N/A	Slide/Raft-#5 Door LH	25	200	N/A	N/A	N/A	N/A	N/A	N/A	N/A	unfolded without cylinder
41	N/A	N/A	N/A	N/A	Flap track Fairing	57	500/600	N/A	N/A	N/A	N/A	69.6"	N/A	N/A	Fracture
42	N/A	N/A	N/A	N/A	LH Wing Inbd Aft T/E Flap attached Middle Flap	57	500	N/A	N/A	N/A	N/A	97.2"	N/A	N/A	Fractured (aft flap 8.1, mid flap 3.6')

47	N/A	N/A	N/A	N/A	N/A	N/A	N/A	N/A	N/A	N/A	N/A	N/A	N/A	N/A	N/A	N/A	N/A	N/A	N/A	112.8"	N/A	N/A	Fore 8.6" Mid 9.4" Alt 8.2"
48	N/A	N/A	N/A	N/A	N/A	N/A	N/A	N/A	N/A	500	500	N/A	N/A	N/A	N/A	N/A	N/A	N/A	N/A	162.0"	N/A	N/A	N/A
49	N/A	N/A	N/A	N/A	N/A	N/A	N/A	N/A	N/A	25	200	N/A	N/A	N/A	N/A	N/A	N/A	N/A	N/A	N/A	N/A	N/A	Unfolded
50	N/A	N/A	N 24 15.90.000	N/A	E 119 23.40.000	none	N/A	N/A	N/A	25	200	N/A	N/A	N/A	N/A	N/A	N/A	N/A	N/A	N/A	N/A	N/A	with reservoir pressure indicated Ops
51	N/A	N/A	N/A	N/A	N/A	N/A	N/A	N/A	N/A	25	200	N/A	N/A	N/A	N/A	N/A	N/A	N/A	N/A	N/A	N/A	N/A	reservoir missing
52	N/A	N/A	N 26 06.10.000	N/A	E 119 27.27.000	none	N/A	N/A	N/A	25	200	N/A	N/A	N/A	N/A	N/A	N/A	N/A	N/A	36.0"	N/A	N/A	AL Honeycomb panel Deform and broken
53	N/A	N/A	N/A	N/A	N/A	N/A	N/A	N/A	N/A	25	200	N/A	N/A	N/A	N/A	N/A	N/A	N/A	N/A	N/A	N/A	N/A	N/A
54	N/A	N/A	N/A	N/A	N/A	N/A	N/A	N/A	N/A	25	200	N/A	N/A	N/A	N/A	N/A	N/A	N/A	N/A	85.2"	N/A	N/A	twist/deform
55	N/A	N/A	N/A	N/A	N/A	none	N/A	N/A	N/A	25	200	N/A	N/A	N/A	N/A	N/A	N/A	N/A	N/A	13.2"	N/A	N/A	N/A
56	N/A	N/A	N 24 09.36.000	N/A	E 119 28.90.000	none	N/A	N/A	N/A	25	200	N/A	N/A	N/A	N/A	N/A	N/A	N/A	N/A	N/A	N/A	N/A	N/A
57	N/A	N/A	N 24 12.27.000	N/A	E 119 30.43.000	none	N/A	N/A	N/A	25	200	N/A	N/A	N/A	N/A	N/A	N/A	N/A	N/A	111.6"	N/A	N/A	N/A
58	N/A	N/A	N 24 01.00.000	N/A	E 119 29.00.000	none	N/A	N/A	N/A	25	200	N/A	N/A	N/A	N/A	N/A	N/A	N/A	N/A	N/A	N/A	N/A	Fracture
59	N/A	N/A	N/A	N/A	N/A	none	N/A	N/A	N/A	57	500/600	N/A	N/A	N/A	N/A	N/A	N/A	N/A	N/A	30.0"	N/A	N/A	Fracture
60	N/A	N/A	N/A	N/A	N/A	none	N/A	N/A	N/A	25	200	N/A	N/A	N/A	N/A	N/A	N/A	N/A	N/A	N/A	N/A	N/A	pressure indicator missing
61	N/A	N/A	N/A	N/A	N/A	N/A	N/A	N/A	N/A	25	200	N/A	N/A	N/A	N/A	N/A	N/A	N/A	N/A	N/A	N/A	N/A	N/A
62	N/A	N/A	N/A	N/A	N/A	N/A	N/A	N/A	N/A	25	200	N/A	N/A	N/A	N/A	N/A	N/A	N/A	N/A	N/A	N/A	N/A	Pressure indicated-opsi
63	N/A	N/A	N/A	N/A	N/A	N/A	N/A	N/A	N/A	25	200	N/A	N/A	N/A	N/A	N/A	N/A	N/A	N/A	N/A	N/A	N/A	Broken
64	N/A	N/A	N/A	N/A	N/A	N/A	N/A	N/A	N/A	25	200	N/A	N/A	N/A	N/A	N/A	N/A	N/A	N/A	35.0"	N/A	N/A	Fracture
66	N/A	N/A	N/A	N/A	N/A	N/A	N/A	N/A	N/A	25	200	N/A	N/A	N/A	N/A	N/A	N/A	N/A	N/A	37.0"	N/A	N/A	N/A
67	N/A	N/A	N/A	N/A	N/A	N/A	N/A	N/A	N/A	53	200	N/A	N/A	N/A	N/A	N/A	N/A	N/A	N/A	147.0"	N/A	N/A	Fracture
68	N/A	N/A	N/A	N/A	N/A	N/A	N/A	N/A	N/A	53	200	N/A	N/A	N/A	N/A	N/A	N/A	N/A	N/A	30.0"	N/A	N/A	Composite
69	N/A	N/A	N/A	N/A	N/A	N/A	N/A	N/A	N/A	27	500/600	N/A	N/A	N/A	N/A	N/A	N/A	N/A	N/A	33.0"	N/A	N/A	N/A
70	not use																						
71	N/A	N/A	N/A	N/A	N/A	N/A	N/A	N/A	N/A	25	200	N/A	N/A	N/A	N/A	N/A	N/A	N/A	N/A	6.7"	N/A	N/A	N/A
72	not use																						
73	N/A	N/A	N/A	N/A	N/A	N/A	N/A	N/A	N/A	25	200	N/A	N/A	N/A	N/A	N/A	N/A	N/A	N/A	N/A	N/A	N/A	N/A
74	N/A	N/A	N/A	N/A	N/A	N/A	N/A	N/A	N/A	25	200	N/A	N/A	N/A	N/A	N/A	N/A	N/A	N/A	N/A	N/A	N/A	N/A
75	N/A	N/A	N/A	N/A	N/A	N/A	N/A	N/A	N/A	25	200	N/A	N/A	N/A	N/A	N/A	N/A	N/A	N/A	N/A	N/A	N/A	N/A
76	N/A	N/A	N/A	N/A	N/A	N/A	N/A	N/A	N/A	53	200	N/A	N/A	N/A	N/A	N/A	N/A	N/A	N/A	40.8"	N/A	N/A	Fracture
77	N/A	N/A	N/A	N/A	N/A	N/A	N/A	N/A	N/A	25	200	N/A	N/A	N/A	N/A	N/A	N/A	N/A	N/A	N/A	N/A	N/A	N/A
78	N/A	N/A	N/A	N/A	N/A	N/A	N/A	N/A	N/A	57	500/600	N/A	N/A	N/A	N/A	N/A	N/A	N/A	N/A	27.6"	N/A	N/A	Broken
79	N/A	N/A	N/A	N/A	N/A	N/A	N/A	N/A	N/A	25	200	N/A	N/A	N/A	N/A	N/A	N/A	N/A	N/A	15.6"	N/A	N/A	Broken
80	N/A	N/A	N/A	N/A	N/A	N/A	N/A	N/A	N/A	57	500/600	N/A	N/A	N/A	N/A	N/A	N/A	N/A	N/A	38.4"	N/A	N/A	Fracture
81	N/A	N/A	N/A	N/A	N/A	N/A	N/A	N/A	N/A	53	200	N/A	N/A	N/A	N/A	N/A	N/A	N/A	N/A	85.2"	N/A	N/A	N/A
82	N/A	N/A	N/A	N/A	N/A	N/A	N/A	N/A	N/A	21	200	N/A	N/A	N/A	N/A	N/A	N/A	N/A	N/A	1.6*12	N/A	N/A	N/A
83	N/A	N/A	N/A	N/A	N/A	N/A	N/A	N/A	N/A	57	500/600	N/A	N/A	N/A	N/A	N/A	N/A	N/A	N/A	32.4"	N/A	N/A	Fracture
84	N/A	N/A	N/A	N/A	N/A	N/A	N/A	N/A	N/A	57	500/600	N/A	N/A	N/A	N/A	N/A	N/A	N/A	N/A	82.8"	N/A	N/A	Fracture
85	N/A	N/A	N/A	N/A	N/A	N/A	N/A	N/A	N/A	25	200	N/A	N/A	N/A	N/A	N/A	N/A	N/A	N/A	28.0"	N/A	N/A	composite
86	N/A	N/A	N/A	N/A	N/A	N/A	N/A	N/A	N/A	53	100	N/A	N/A	N/A	N/A	N/A	N/A	N/A	N/A	32.0"	N/A	N/A	Broken
87	N/A	N/A	N/A	N/A	N/A	N/A	N/A	N/A	N/A	57	500/600	N/A	N/A	N/A	N/A	N/A	N/A	N/A	N/A	32.0"	N/A	N/A	Fracture/Composite
88	N/A	N/A	N/A	N/A	N/A	N/A	N/A	N/A	N/A	25	200	N/A	N/A	N/A	N/A	N/A	N/A	N/A	N/A	20.0"	N/A	N/A	Deform/Composite
89	N/A	N/A	N/A	N/A	N/A	N/A	N/A	N/A	N/A	21	200	N/A	N/A	N/A	N/A	N/A	N/A	N/A	N/A	11.0"	N/A	N/A	composite
90	N/A	N/A	N/A	N/A	N/A	N/A	N/A	N/A	N/A	25	200	N/A	N/A	N/A	N/A	N/A	N/A	N/A	N/A	35.0"	N/A	N/A	composite
91	N/A	N/A	N/A	N/A	N/A	N/A	N/A	N/A	N/A	25	200	N/A	N/A	N/A	N/A	N/A	N/A	N/A	N/A	36.0"	N/A	N/A	composite
92	N/A	N/A	N/A	N/A	N/A	N/A	N/A	N/A	N/A	25	200	N/A	N/A	N/A	N/A	N/A	N/A	N/A	N/A	17.0"	N/A	N/A	composite
93	N/A	N/A	N/A	N/A	N/A	N/A	N/A	N/A	N/A	21	200	N/A	N/A	N/A	N/A	N/A	N/A	N/A	N/A	24.0"	N/A	N/A	composite
94	N/A	N/A	N/A	N/A	N/A	N/A	N/A	N/A	N/A	54	400	N/A	N/A	N/A	N/A	N/A	N/A	N/A	N/A	15.0"	N/A	N/A	composite
95	N/A	N/A	N/A	N/A	N/A	N/A	N/A	N/A	N/A	25	200	N/A	N/A	N/A	N/A	N/A	N/A	N/A	N/A	90.0"	N/A	N/A	composite-deform/fracture
96	N/A	N/A	N/A	N/A	N/A	N/A	N/A	N/A	N/A	53	200	N/A	N/A	N/A	N/A	N/A	N/A	N/A	N/A	22.0"	N/A	N/A	Fracture/Composite
97	N/A	N/A	N/A	N/A	N/A	N/A	N/A	N/A	N/A	21	200	N/A	N/A	N/A	N/A	N/A	N/A	N/A	N/A	144.0"	0.4"	N/A	part/composite
98	N/A	N/A	N/A	N/A	N/A	N/A	N/A	N/A	N/A	57	500/600	N/A	N/A	N/A	N/A	N/A	N/A	N/A	N/A	42.0"	N/A	N/A	composite
99	N/A	N/A	N/A	N/A	N/A	N/A	N/A	N/A	N/A	57	500/600	N/A	N/A	N/A	N/A	N/A	N/A	N/A	N/A	15.0"	N/A	N/A	composite
100	N/A	N/A	N/A	N/A	N/A	N/A	N/A	N/A	N/A	26	200	N/A	N/A	N/A	N/A	N/A	N/A	N/A	N/A	N/A	N/A	N/A	N/A

157	N/A	N/A	N/A	N/A	N/A	N/A	N/A	N/A	N/A	N/A	N/A	N/A	N/A	47.0"	34.0"	N/A	N/A	composite
158	not use	N/A	N/A	N/A	N/A	N/A	N/A	N/A	N/A	N/A	N/A	N/A	N/A	40.0"	58.0"	N/A	N/A	Fracture
159	N/A	N/A	N/A	N/A	N/A	N/A	N/A	N/A	N/A	N/A	N/A	N/A	N/A	40.0"	58.0"	N/A	N/A	Fracture
160	not use	N/A	N/A	N/A	N/A	N/A	N/A	N/A	N/A	N/A	N/A	N/A	N/A	19.0"	16.0"	N/A	N/A	composite
161	N/A	N/A	N/A	N/A	N/A	N/A	N/A	N/A	N/A	N/A	N/A	N/A	N/A	72.0"	3.0"	N/A	N/A	Fracture
162	not use	N/A	N/A	N/A	N/A	N/A	N/A	N/A	N/A	N/A	N/A	N/A	N/A	60.0"	23.0"	N/A	N/A	N/A
163	N/A	N/A	N/A	N/A	N/A	N/A	N/A	N/A	N/A	N/A	N/A	N/A	N/A	35.0"	19.0"	N/A	N/A	N/A
164	not use	N/A	N/A	N/A	N/A	N/A	N/A	N/A	N/A	N/A	N/A	N/A	N/A	35.0"	19.0"	N/A	N/A	N/A
165	not use	N/A	N/A	N/A	N/A	N/A	N/A	N/A	N/A	N/A	N/A	N/A	N/A	60.0"	23.0"	N/A	N/A	N/A
166	N/A	N/A	N/A	N/A	N/A	N/A	N/A	N/A	N/A	N/A	N/A	N/A	N/A	35.0"	19.0"	N/A	N/A	N/A
167	N/A	N/A	N/A	N/A	N/A	N/A	N/A	N/A	N/A	N/A	N/A	N/A	N/A	35.0"	19.0"	N/A	N/A	N/A
168	not use	N/A	N/A	N/A	N/A	N/A	N/A	N/A	N/A	N/A	N/A	N/A	N/A	18.5"	18.5"	N/A	N/A	N/A
169	N/A	N/A	N/A	N/A	N/A	N/A	N/A	N/A	N/A	N/A	N/A	N/A	N/A	47.0"	25.0"	N/A	N/A	Fracture
170	N/A	N/A	N/A	N/A	N/A	N/A	N/A	N/A	N/A	N/A	N/A	N/A	N/A	36.0"	13.0"	N/A	N/A	N/A
171	N/A	N/A	N/A	N/A	N/A	N/A	N/A	N/A	N/A	N/A	N/A	N/A	N/A	53.0"	27.0"	N/A	N/A	Fracture
172	N/A	N/A	N/A	N/A	N/A	N/A	N/A	N/A	N/A	N/A	N/A	N/A	N/A	40.0"	12.0"	N/A	N/A	Fracture/Composite
173	N/A	N/A	N/A	N/A	N/A	N/A	N/A	N/A	N/A	N/A	N/A	N/A	N/A	81.0"	41.5"	N/A	N/A	N/A
174	N/A	N/A	N/A	N/A	N/A	N/A	N/A	N/A	N/A	N/A	N/A	N/A	N/A	25.0"	12.0"	N/A	N/A	Fracture/Composite
175	not use	N/A	N/A	N/A	N/A	N/A	N/A	N/A	N/A	N/A	N/A	N/A	N/A	50.0"	34.0"	N/A	N/A	N/A
176	N/A	N/A	N/A	N/A	N/A	N/A	N/A	N/A	N/A	N/A	N/A	N/A	N/A	70.0"	20.0"	N/A	N/A	N/A
177	not use	N/A	N/A	N/A	N/A	N/A	N/A	N/A	N/A	N/A	N/A	N/A	N/A	80.0"	31.0"	N/A	N/A	N/A
178	N/A	N/A	N/A	N/A	N/A	N/A	N/A	N/A	N/A	N/A	N/A	N/A	N/A	110.0"	63.0"	N/A	N/A	Fracture
179	not use	N/A	N/A	N/A	N/A	N/A	N/A	N/A	N/A	N/A	N/A	N/A	N/A	66.0"	22.0"	N/A	N/A	Fracture
180	not use	N/A	N/A	N/A	N/A	N/A	N/A	N/A	N/A	N/A	N/A	N/A	N/A	N/A	N/A	N/A	N/A	N/A
181	N/A	N/A	N/A	N/A	N/A	N/A	N/A	N/A	N/A	N/A	N/A	N/A	N/A	N/A	N/A	N/A	N/A	N/A
182	N/A	N/A	N/A	N/A	N/A	N/A	N/A	N/A	N/A	N/A	N/A	N/A	N/A	N/A	N/A	N/A	N/A	N/A
183	N/A	N/A	N/A	N/A	N/A	N/A	N/A	N/A	N/A	N/A	N/A	N/A	N/A	N/A	N/A	N/A	N/A	N/A
184	N/A	N/A	N/A	N/A	N/A	N/A	N/A	N/A	N/A	N/A	N/A	N/A	N/A	N/A	N/A	N/A	N/A	N/A
185	not use	N/A	N/A	N/A	N/A	N/A	N/A	N/A	N/A	N/A	N/A	N/A	N/A	N/A	N/A	N/A	N/A	N/A
186	N/A	N/A	N/A	N/A	N/A	N/A	N/A	N/A	N/A	N/A	N/A	N/A	N/A	N/A	N/A	N/A	N/A	twist
187	N/A	N/A	N/A	N/A	N/A	N/A	N/A	N/A	N/A	N/A	N/A	N/A	N/A	N/A	N/A	N/A	N/A	N/A
188	N/A	N/A	N/A	N/A	N/A	N/A	N/A	N/A	N/A	N/A	N/A	N/A	N/A	120.0"	74.0"	N/A	N/A	Fracture
189	N/A	N/A	N/A	N/A	N/A	N/A	N/A	N/A	N/A	N/A	N/A	N/A	N/A	165.0"	14.0"	N/A	N/A	N/A
190	N/A	N/A	N/A	N/A	N/A	N/A	N/A	N/A	N/A	N/A	N/A	N/A	N/A	N/A	N/A	N/A	N/A	Fracture
191	N/A	N/A	N/A	N/A	N/A	N/A	N/A	N/A	N/A	N/A	N/A	N/A	N/A	39.0"	30.0"	N/A	N/A	Fracture/Composite
192	N/A	N/A	N/A	N/A	N/A	N/A	N/A	N/A	N/A	N/A	N/A	N/A	N/A	40.0"	36.0"	N/A	N/A	Fracture
193	N/A	N/A	N/A	N/A	N/A	N/A	N/A	N/A	N/A	N/A	N/A	N/A	N/A	204.0"	34.0"	N/A	N/A	Fracture/Composite/Support
194	not use	N/A	N/A	N/A	N/A	N/A	N/A	N/A	N/A	N/A	N/A	N/A	N/A	40.5"	24.0"	N/A	N/A	composite
195	N/A	N/A	N/A	N/A	N/A	N/A	N/A	N/A	N/A	N/A	N/A	N/A	N/A	34.0"	32.0"	N/A	N/A	N/A
196	N/A	N/A	N/A	N/A	N/A	N/A	N/A	N/A	N/A	N/A	N/A	N/A	N/A	40.0"	28.0"	N/A	N/A	Fracture
197	not use	N/A	N/A	N/A	N/A	N/A	N/A	N/A	N/A	N/A	N/A	N/A	N/A	29.0"	19.0"	N/A	N/A	Fracture/Composite
198	N/A	N/A	N/A	N/A	N/A	N/A	N/A	N/A	N/A	N/A	N/A	N/A	N/A	67.0"	35.0"	N/A	N/A	Fracture/Composite
199	N/A	N/A	N/A	N/A	N/A	N/A	N/A	N/A	N/A	N/A	N/A	N/A	N/A	50.0"	43.0"	N/A	N/A	Fracture/Composite
200	N/A	N/A	N/A	N/A	N/A	N/A	N/A	N/A	N/A	N/A	N/A	N/A	N/A	N/A	N/A	N/A	N/A	twist/Fracture
201	N/A	N/A	N/A	N/A	N/A	N/A	N/A	N/A	N/A	N/A	N/A	N/A	N/A	75.0"	N/A	N/A	N/A	Fracture
202	N/A	N/A	N/A	N/A	N/A	N/A	N/A	N/A	N/A	N/A	N/A	N/A	N/A	24.0"	12.0"	N/A	N/A	Fracture/Composite
203	N/A	N/A	N/A	N/A	N/A	N/A	N/A	N/A	N/A	N/A	N/A	N/A	N/A	32.0"	19.0"	N/A	N/A	Composite
204	N/A	N/A	N/A	N/A	N/A	N/A	N/A	N/A	N/A	N/A	N/A	N/A	N/A	17.0"	20.0"	N/A	N/A	N/A
205	N/A	N/A	N/A	N/A	N/A	N/A	N/A	N/A	N/A	N/A	N/A	N/A	N/A	37.0"	37.0"	N/A	N/A	Fracture
206	N/A	N/A	N/A	N/A	N/A	N/A	N/A	N/A	N/A	N/A	N/A	N/A	N/A	35.0"	32.0"	N/A	N/A	Fracture
207	N/A	N/A	N/A	N/A	N/A	N/A	N/A	N/A	N/A	N/A	N/A	N/A	N/A	25.0"	15.0"	N/A	N/A	Fracture/Composite
208	N/A	N/A	N/A	N/A	N/A	N/A	N/A	N/A	N/A	N/A	N/A	N/A	N/A	103.0"	31.0"	N/A	N/A	N/A
209	N/A	N/A	N/A	N/A	N/A	N/A	N/A	N/A	N/A	N/A	N/A	N/A	N/A	53.0"	42.0"	N/A	N/A	Composite
210	N/A	N/A	N/A	N/A	N/A	N/A	N/A	N/A	N/A	N/A	N/A	N/A	N/A	N/A	N/A	N/A	N/A	not aircraft part
211	N/A	N/A	N/A	N/A	N/A	N/A	N/A	N/A	N/A	N/A	N/A	N/A	N/A	N/A	N/A	N/A	N/A	N/A
212	N/A	N/A	N/A	N/A	N/A	N/A	N/A	N/A	N/A	N/A	N/A	N/A	N/A	N/A	N/A	N/A	N/A	N/A

213	N/A	N/A	N/A	N/A	N/A	L/G Door partial portion-AL Composite	32	700	N/A	N/A	N/A	N/A	35.0"	24.0"	N/A	Fracture
214	N/A	N/A	N/A	N/A	N/A	Vent Duct-Plastic	21	200	N/A	N/A	N/A	N/A	29.0"	19.0"	N/A	Fracture
215	N/A	N/A	N/A	N/A	N/A	Bin panel	25	200	N/A	N/A	N/A	N/A	N/A	N/A	N/A	Fracture/Composite
216	N/A	N/A	N/A	N/A	N/A	Floor panel	25	200	N/A	N/A	N/A	N/A	56.0"	39.0"	N/A	Fracture
217	not use	N/A	N/A	N/A	N/A	trolley panel	25	200	N/A	N/A	N/A	N/A	31.0"	31.0"	N/A	twist
219	N/A	N/A	N/A	N/A	N/A	Decoration panel(one set)	25	200	N/A	N/A	N/A	N/A	N/A	N/A	N/A	N/A
220	N/A	N/A	N/A	N/A	N/A	Composite panel	25	200	N/A	N/A	N/A	N/A	42.0"	11.0"	N/A	Fracture
221	N/A	N/A	N/A	N/A	N/A	Floor panel-Honeycomb	25	200	N/A	N/A	N/A	N/A	49.0"	2.0"	N/A	N/A
222	N/A	N/A	N/A	N/A	N/A	Composite panel	25	200	N/A	N/A	N/A	N/A	22.0"	11.0"	N/A	Fracture
223	not use	N/A	N/A	N/A	N/A	Bin & Bin support	25	200	N/A	N/A	N/A	N/A	52.0"	21.0"	N/A	Fracture
224	N/A	N/A	N/A	N/A	N/A	Composite panel	25	200	N/A	N/A	N/A	N/A	35.0"	20.0"	N/A	Fracture
226	not use	N/A	N/A	N/A	N/A	Composite panel	N/A	N/A	N/A	N/A	N/A	N/A	46.0"	34.0"	N/A	Fracture
227	N/A	N/A	N/A	N/A	N/A	Bin Door-Composite	25	200	N/A	N/A	N/A	N/A	45.0"	22.0"	N/A	Composite
228	N/A	N/A	N/A	N/A	N/A	Bin Door-Composite	25	200	N/A	N/A	N/A	N/A	45.0"	22.0"	N/A	Composite
229-230	not use	N/A	N/A	N/A	N/A	Outpod LH Fore Flap partial portion	57	500/600	N/A	N/A	N/A	N/A	79.0"	24.0"	N/A	Fracture
231	N/A	N/A	N/A	N/A	N/A	Vent Duct(Galley)-plastic	25	200	N/A	N/A	N/A	N/A	41.0"	28.0"	N/A	Fracture
232	N/A	N/A	N/A	N/A	N/A	Partition	21	200	N/A	N/A	N/A	N/A	63.0"	13.0"	N/A	Fracture/Composite
234	N/A	N/A	N/A	N/A	N/A	Manifold Duct-plastic	21	200	N/A	N/A	N/A	N/A	N/A	N/A	N/A	Broken
235	N/A	N/A	N/A	N/A	N/A	Bin Door 22"x68"	25	200	N/A	N/A	N/A	N/A	25.0"	22.0"	N/A	Fracture/Composite
236-237	not use	N/A	N/A	N/A	N/A	LH Outboard Aileron(x)	57	500	N/A	N/A	N/A	N/A	N/A	N/A	N/A	N/A
238	N/A	N/A	N/A	N/A	N/A	Floor panel/Seat track	25	200	N/A	N/A	N/A	N/A	66.0"	46.0"	N/A	N/A
240	N/A	N/A	N/A	N/A	N/A	Composite panel	57	500/600	N/A	N/A	N/A	N/A	N/A	N/A	N/A	Fracture/composite
241	N/A	N/A	N/A	N/A	N/A	Law/Galley Floor Panel	53	200	N/A	N/A	N/A	N/A	21.0"	25.0"	N/A	Fracture
242	N/A	N/A	N/A	N/A	N/A	Floor Panel-cockpit	53	200	N/A	N/A	N/A	N/A	25.0"	24.0"	N/A	Twist/Fracture
243	N/A	N/A	N/A	N/A	N/A	Composite panel	N/A	N/A	N/A	N/A	N/A	N/A	20.0"	22.0"	N/A	Fracture
244	N/A	N/A	N/A	N/A	N/A	LH Wing lip-T/E Panel & Fuel Dump tub	57	500	N/A	N/A	N/A	N/A	34.0"	20.0"	N/A	Fracture
245	N/A	N/A	N/A	N/A	N/A	Composite panel	57	500/600	N/A	N/A	N/A	N/A	27.0"	13.0"	N/A	Fracture
246	N/A	N/A	N/A	N/A	N/A	Partition	25	200	N/A	N/A	N/A	N/A	N/A	N/A	N/A	Fracture/Composite
247	N/A	N/A	N/A	N/A	N/A	Composite panel	53	100	N/A	N/A	N/A	N/A	30.5"	17.0"	N/A	Fracture
248	N/A	N/A	N/A	N/A	N/A	Ceiling panel	25	200	N/A	N/A	N/A	N/A	N/A	N/A	N/A	Fracture/Composite
249	N/A	N/A	N/A	N/A	N/A	Filler Failing Horizontal Stab(x)	55	300	N/A	N/A	N/A	N/A	N/A	N/A	N/A	N/A
250	N/A	N/A	N/A	N/A	N/A	Frame STA 1940	53	200	1940	1940	46	3L/11L	84.0"	5.0"	N/A	N/A
251	N/A	N/A	N/A	N/A	N/A	CTR Support Beam	25	200	N/A	N/A	N/A	N/A	13.5"	10.0"	N/A	N/A
252	N/A	N/A	N/A	N/A	N/A	CTR Support Beam	25	200	N/A	N/A	N/A	N/A	80.0"	17.0"	N/A	N/A
253	N/A	N/A	N/A	N/A	N/A	Container Door	25	200	N/A	N/A	N/A	N/A	59.0"	54.0"	N/A	N/A
254	N/A	N/A	N/A	N/A	N/A	CTR Storage Bin Support	25	200	N/A	N/A	N/A	N/A	46.0"	16.0"	N/A	N/A
255	N/A	N/A	N/A	N/A	N/A	Non-Aircraft part(Foreign object)	x	N/A	N/A	N/A	N/A	N/A	N/A	N/A	N/A	N/A
256	N/A	N/A	N/A	N/A	N/A	Pax window sun shade	25	200	N/A	N/A	N/A	N/A	20.0"	13.0"	N/A	N/A
257	N/A	N/A	N/A	N/A	N/A	CTR Storage Bin	25	200	N/A	N/A	N/A	N/A	31.0"	25.0"	N/A	N/A
258	N/A	N/A	N/A	N/A	N/A	Floor Panel	25	200	N/A	N/A	N/A	N/A	40.0"	15.0"	N/A	N/A
259	N/A	N/A	N/A	N/A	N/A	Pax Seat 280E	25	500	N/A	N/A	N/A	N/A	44.0"	42.0"	N/A	N/A
260	N/A	N/A	N/A	N/A	N/A	LH INBD Aileron	57	200	N/A	N/A	N/A	N/A	74.0"	52.0"	N/A	N/A
261	N/A	N/A	N/A	N/A	N/A	CTR Support Beam	25	200	N/A	N/A	N/A	N/A	15.0"	13.5"	N/A	N/A
262	N/A	N/A	N/A	N/A	N/A	Floor Panel	25	200	N/A	N/A	N/A	N/A	57.0"	17.0"	N/A	N/A
263	N/A	N/A	N/A	N/A	N/A	Outbd upper Fix Panel	57	500/600	N/A	N/A	N/A	N/A	66.0"	17.0"	N/A	N/A
264	N/A	N/A	N/A	N/A	N/A	Side wall Panel(LAV)	25	200	N/A	N/A	N/A	N/A	79.0"	35.0"	N/A	N/A
265	N/A	N/A	N/A	N/A	N/A	Galley Door & composite panel	25	200	N/A	N/A	N/A	N/A	N/A	N/A	N/A	Fracture
266	N/A	N/A	N/A	N/A	N/A	Lav Door	25	200	N/A	N/A	N/A	N/A	70.0"	19.5"	N/A	N/A
267	N/A	N/A	N/A	N/A	N/A	PylonAccess Door	54	400	N/A	N/A	N/A	N/A	11.0"	6.5"	N/A	N/A
268	N/A	N/A	N/A	N/A	N/A	Aft & Bulk Cargo Divider	25	100	N/A	N/A	N/A	N/A	43.0"	22.0"	N/A	N/A
269	not use	N/A	N/A	N/A	N/A	Fuseläge skin STA 1920-1940/S-22-25	53	200	N/A	N/A	N/A	N/A	23.0"	25.0"	N/A	N/A
270	N/A	N/A	N/A	N/A	N/A	Fuseläge skin STA 1920-1940/S-22-25	53	200	N/A	N/A	N/A	N/A	23.0"	25.0"	N/A	N/A

328	N/A	N/A	N/A	N/A	25	200	N/A	N/A	N/A	N/A	N/A	44.0"	21.0"	N/A	N/A
329	N/A	N/A	N/A	N/A	25	200	N/A	N/A	N/A	N/A	N/A	41.0"	11.0"	N/A	N/A
330	N/A	N/A	N/A	N/A	53	100	1800	46	30L/39L	N/A	N/A	62.0"	10.0"	N/A	N/A
331	N/A	N/A	N/A	N/A	53	100	2160	46	32R/36R	N/A	N/A	35.0"	9.0"	N/A	N/A
332	N/A	N/A	N/A	N/A	25	200	N/A	N/A	N/A	N/A	N/A	47.0"	20.0"	N/A	deform/fracture
333	N/A	N/A	N/A	N/A	54	400	N/A	N/A	N/A	N/A	N/A	63.0"	35.0"	N/A	N/A
334	N/A	N/A	N/A	N/A	25	200	N/A	N/A	N/A	N/A	N/A	27.0"	N/A	N/A	N/A
335	N/A	N/A	N/A	N/A	25	200	N/A	N/A	N/A	N/A	N/A	44.0"	42.0"	N/A	N/A
336	N/A	N/A	N/A	N/A	25	200	N/A	N/A	N/A	N/A	N/A	23.0"	17.0"	N/A	N/A
337	N/A	N/A	N/A	N/A	25	200	N/A	N/A	N/A	N/A	N/A	67.0"	32.0"	N/A	N/A
338	N/A	N/A	N/A	N/A	21	200	N/A	N/A	N/A	N/A	N/A	65.0"	N/A	N/A	N/A
339	N/A	N/A	N/A	N/A	27	500/600	N/A	N/A	N/A	N/A	N/A	54.0"	53.0"	N/A	N/A
340	N/A	N/A	N/A	N/A	35	100	N/A	N/A	N/A	N/A	N/A	N/A	N/A	N/A	N/A
341	N/A	N/A	N/A	N/A	25	200	N/A	N/A	N/A	N/A	N/A	31.0"	22.0"	N/A	N/A
342	N/A	N/A	N/A	N/A	25	200	N/A	N/A	N/A	N/A	N/A	28.0"	2.0"	N/A	N/A
343	N/A	N/A	N/A	N/A	53	500/600	N/A	N/A	N/A	N/A	N/A	36.0"	23.0"	N/A	N/A
344	N/A	N/A	N/A	N/A	25	200	N/A	N/A	N/A	N/A	N/A	54.0"	6.0"	N/A	N/A
345	N/A	N/A	N/A	N/A	25	200	N/A	N/A	N/A	N/A	N/A	35.0"	36.0"	N/A	N/A
346	N/A	N/A	N/A	N/A	21	200	N/A	N/A	N/A	N/A	N/A	60.0"	N/A	N/A	N/A
347	N/A	N/A	N/A	N/A	25	200	N/A	N/A	N/A	N/A	N/A	34.0"	25.0"	N/A	N/A
348	N/A	N/A	N/A	N/A	25	200	N/A	N/A	N/A	N/A	N/A	46.0"	24.0"	N/A	N/A
349	N/A	N/A	N/A	N/A	25	200	N/A	N/A	N/A	N/A	N/A	49.0"	39.0"	N/A	N/A
350	N/A	N/A	N/A	N/A	55	300	N/A	N/A	N/A	N/A	N/A	54.0"	36.0"	N/A	N/A
351	N/A	N/A	N/A	N/A	25	200	N/A	N/A	N/A	N/A	N/A	26.0"	19.0"	N/A	N/A
352	N/A	N/A	N/A	N/A	25	200	N/A	N/A	N/A	N/A	N/A	22.0"	19.0"	N/A	N/A
353	N/A	N/A	N/A	N/A	53	200	N/A	N/A	N/A	N/A	N/A	76.0"	46.0"	N/A	N/A
354	N/A	N/A	N/A	N/A	25	200	N/A	N/A	N/A	N/A	N/A	10.5"	40.0"	N/A	N/A
355	N/A	N/A	N/A	N/A	25	200	N/A	N/A	N/A	N/A	N/A	15.0"	16.0"	N/A	N/A
356	N/A	N/A	N/A	N/A	25	200	N/A	N/A	N/A	N/A	N/A	39.0"	16.5"	N/A	N/A
357	N/A	N/A	N/A	N/A	25	200	N/A	N/A	N/A	N/A	N/A	30.0"	42.0"	N/A	N/A
358	N/A	N/A	N/A	N/A	25	200	N/A	N/A	N/A	N/A	N/A	23.0"	18.0"	N/A	N/A
359	N/A	N/A	N/A	N/A	25	200	N/A	N/A	N/A	N/A	N/A	38.0"	19.5"	N/A	N/A
360	N/A	N/A	N/A	N/A	57	500/600	N/A	N/A	N/A	N/A	N/A	18.5"	23.0"	N/A	N/A
361	N/A	N/A	N/A	N/A	25	200	N/A	N/A	N/A	N/A	N/A	39.0"	27.0"	N/A	N/A
362	N/A	N/A	N/A	N/A	25	200	N/A	N/A	N/A	N/A	N/A	27.0"	21.0"	N/A	N/A
363	N/A	N/A	N/A	N/A	25	200	N/A	N/A	N/A	N/A	N/A	34.0"	34.0"	N/A	N/A
364	N/A	N/A	N/A	N/A	25	200	N/A	N/A	N/A	N/A	N/A	21.0"	14.0"	N/A	N/A
365	N/A	N/A	N/A	N/A	25	200	N/A	N/A	N/A	N/A	N/A	44.0"	26.0"	N/A	N/A
366	N/A	N/A	N/A	N/A	21	200	N/A	N/A	N/A	N/A	N/A	25.0"	N/A	N/A	N/A
367	N/A	N/A	N/A	N/A	25	200	N/A	N/A	N/A	N/A	N/A	39.0"	27.0"	N/A	N/A
368	N/A	N/A	N/A	N/A	25	200	N/A	N/A	N/A	N/A	N/A	27.0"	20.0"	N/A	N/A
369	N/A	N/A	N/A	N/A	25	200	N/A	N/A	N/A	N/A	N/A	59.0"	26.0"	N/A	N/A
370	N/A	N/A	N/A	N/A	25	200	N/A	N/A	N/A	N/A	N/A	21.0"	29.0"	N/A	N/A
371	N/A	N/A	N/A	N/A	21	200	N/A	N/A	N/A	N/A	N/A	65.0"	16.0"	N/A	N/A
372	N/A	N/A	N/A	N/A	57	500/600	N/A	N/A	N/A	N/A	N/A	40.0"	15.5"	N/A	N/A
373	N/A	N/A	N/A	N/A	25	200	N/A	N/A	N/A	N/A	N/A	82.0"	16.0"	8.0"	N/A
374	N/A	N/A	N/A	N/A	25	200	N/A	N/A	N/A	N/A	N/A	33.0"	20.0"	N/A	N/A
375	N/A	N/A	N/A	N/A	25	200	N/A	N/A	N/A	N/A	N/A	80.0"	41.0"	N/A	N/A
376	N/A	N/A	N/A	N/A	25	200	N/A	N/A	N/A	N/A	N/A	19.0"	14.0"	N/A	N/A
377	N/A	N/A	N/A	N/A	53	100	N/A	N/A	N/A	N/A	N/A	37.0"	28.0"	N/A	N/A
378	N/A	N/A	N/A	N/A	25	200	N/A	N/A	N/A	N/A	N/A	43.0"	27.0"	N/A	N/A
379	N/A	N/A	N/A	N/A	25	200	N/A	N/A	N/A	N/A	N/A	40.0"	33.0"	N/A	N/A
380	N/A	N/A	N/A	N/A	25	200	N/A	N/A	N/A	N/A	N/A	66.0"	17.0"	N/A	N/A
381	N/A	N/A	N/A	N/A	25	200	N/A	N/A	N/A	N/A	N/A	25.0"	33.0"	N/A	N/A
382	N/A	N/A	N/A	N/A	25	200	N/A	N/A	N/A	N/A	N/A	38.0"	40.0"	N/A	N/A
383	N/A	N/A	N/A	N/A	25	200	N/A	N/A	N/A	N/A	N/A	40.0"	36.0"	N/A	N/A

440	N/A	N/A	N/A	N/A	Floor Panel	25	200	N/A	N/A	N/A	N/A	48.0"	35.0"	N/A	N/A	
441	N/A	N/A	N/A	N/A	Coupling manifold(PIN:AV748801-3)	38	200	N/A	N/A	N/A	N/A	44.0"	17.0"	N/A	N/A	
442	N/A	N/A	N/A	N/A	Partition Panel	25	200	N/A	N/A	N/A	N/A	23.0"	60.0"	N/A	N/A	
443	not use															
444	N/A	N/A	N/A	N/A	Partition Panel	25	200	N/A	N/A	N/A	N/A	13.0"	60.0"	N/A	N/A	
445	N/A	N 24 21 00.000	E 119 16 00.000	none	Rudder Trailing edge	55	300	N/A	N/A	N/A	N/A	26.0"	9.0"	N/A	N/A	
446	N/A	N 24 21 00.000	E 119 16 00.000	none	LH LE upper Fix panel(NO.3 PDU)	57	500	N/A	N/A	N/A	N/A	39.0"	49.0"	N/A	N/A	
447	N/A	N/A	N/A	N/A	Floor Panel	25	200	N/A	N/A	N/A	N/A	29.0"	27.0"	N/A	N/A	
448	N/A	N/A	N/A	N/A	Fuselage Fairing	53	100	N/A	N/A	N/A	N/A	28.0"	15.0"	N/A	N/A	
449	N/A	N/A	N/A	N/A	Galley Side wall Panel	25	200	N/A	N/A	N/A	N/A	51.0"	20.0"	N/A	N/A	
450	N/A	N/A	N/A	N/A	Strap	25	200	N/A	N/A	N/A	N/A	45.0"	3.0"	N/A	N/A	
451	N/A	N/A	N/A	N/A	Floor Panel	25	200	N/A	N/A	N/A	N/A	44.0"	62.0"	N/A	N/A	
452	N/A	N/A	N/A	N/A	Wing upper FWD Fixed Panel	57	500/600	N/A	N/A	N/A	N/A	40.0"	54.0"	N/A	N/A	
453	N/A	N 24 32-18-000	120.04.24	none	Partition Panel	25	200	N/A	N/A	N/A	N/A	36.0"	50.0"	N/A	N/A	
454	N/A	N/A	N/A	N/A	0.02"web(to be identified TBI)	N/A	N/A	N/A	N/A	N/A	N/A	7.0"	7.0"	N/A	N/A	
455	N/A	N/A	N/A	N/A	Hyd bracket strut mount(USED ON 65690170)	54	400	N/A	N/A	N/A	N/A	3.5"	3.5"	N/A	N/A	
456	N/A	N/A	N/A	N/A	Flap track fairing	27	500/600	N/A	N/A	N/A	N/A	41.0"	23.0"	N/A	N/A	
457	N/A	N/A	N/A	N/A	Wing LE upper fixed panel,rib,LE Flap Nose Flap rotary & torque tub	57	500/600	N/A	N/A	N/A	N/A	68.0"	44.0"	N/A	N/A	
458	N/A	N/A	N/A	N/A	Wing LE upper fixed panel,rib,LE Flap Nose Flap rotary & torque tub	57	500/600	N/A	N/A	N/A	N/A	44.0"	40.0"	N/A	N/A	
459	N/A	N/A	N/A	N/A	Wing LE upper fixed panel,tube	57	500/600	N/A	N/A	N/A	N/A	57.0"	41.0"	N/A	N/A	
460	N/A	N/A	N/A	N/A	Storage bin panel	25	200	N/A	N/A	N/A	N/A	34.0"	7.0"	N/A	N/A	
461	N/A	N/A	N/A	N/A	Storage bin panel	25	200	N/A	N/A	N/A	N/A	34.0"	13.0"	N/A	N/A	
462	N/A	N 23 05 80.960	E 119 40 33.700	none	55" Cargo loading pullet,tickdown fracture	25	100	N/A	N/A	N/A	N/A	N/A	N/A	N/A	N/A	
463	not use															
464	N/A	N/A	N/A	N/A	Storage bin panel	25	200	N/A	N/A	N/A	N/A	60.0"	11.0"	N/A	N/A	
465	N/A	N 24 34 00.000	E 120 20 00.000	none	Floor panel-Honeycomb composite	25	200	N/A	N/A	N/A	N/A	61.0"	22.0"	N/A	N/A	
466	N/A	N/A	N/A	N/A	Air condition pack, pneumatic-Duct	21	21	N/A	N/A	N/A	N/A	29.0"		N/A	N/A	
467	N/A	N/A	N/A	N/A	Composite panel-storage bin panel	25	200	N/A	N/A	N/A	N/A	37.0"	19.0"	N/A	N/A	
468	N/A	N/A	N/A	N/A	Storage bin panel	25	200	N/A	N/A	N/A	N/A	30.0"	12.0"	N/A	N/A	
469	N/A	N/A	N/A	N/A	Storage bin panel	25	200	N/A	N/A	N/A	N/A	39.0"	23.0"	N/A	N/A	
470	N/A	N/A	N/A	N/A	Life jacket(2EA) one has inflated other one is not	25	200	N/A	N/A	N/A	N/A	N/A	N/A	N/A	N/A	
471	N/A	N/A	N/A	N/A	Floor panel-Honeycomb composite	25	200	N/A	N/A	N/A	N/A	46.0"	24.0"	N/A	N/A	
472	N/A	N/A	N/A	N/A	Wing LE Nose lip skin	57	500/600	N/A	N/A	N/A	N/A	27.0"	5.5"	N/A	N/A	
473	N/A	N/A	N/A	N/A	Wing LE upper fixed panel	57	500/600	N/A	N/A	N/A	N/A	17.0"	11.0"	N/A	N/A	
474	N/A	N/A	N/A	N/A	Floor panel-Honeycomb composite	25	200	N/A	N/A	N/A	N/A	31.0"	18.0"	N/A	N/A	
475	N/A	N/A	N/A	N/A	#1 Hyd ADP Pump	29	400	N/A	N/A	N/A	N/A	23.0"	10.0"	N/A	N/A	
476	N/A	N/A	N/A	N/A	Vent Duct	21	200	N/A	N/A	N/A	N/A	N/A	N/A	N/A	N/A	
477	N/A	N/A	N/A	N/A	#1 Hyd ADP Driver	29	400	N/A	N/A	N/A	N/A	N/A	N/A	N/A	N/A	
478	N/A	N/A	N/A	N/A	Ftn panel	55	300	N/A	N/A	N/A	N/A	N/A	N/A	N/A	N/A	
479	N/A	N/A	N/A	N/A	Wing Nose Lip	57	500/600	N/A	N/A	N/A	N/A	N/A	N/A	N/A	N/A	N/A
480	N/A	N/A	N/A	N/A	Stow bin panel	25	200	N/A	N/A	N/A	N/A	35.0"	13.0"	N/A	N/A	
481	N/A	N/A	N/A	N/A	Stow bin panel	25	200	N/A	N/A	N/A	N/A	20.0"	10.0"	N/A	N/A	
482	N/A	N/A	N/A	N/A	Composite panel	25	200	N/A	N/A	N/A	N/A	22.0"	12.0"	N/A	N/A	
483	N/A	N/A	N/A	N/A	Preu. Duct	36	200	N/A	N/A	N/A	N/A	8.0"	18.5"	N/A	N/A	
484	N/A	N/A	N/A	N/A	Floor panel-Honeycomb composite	25	200	N/A	N/A	N/A	N/A	26.5"	13.7"	N/A	N/A	
485	N/A	N/A	N/A	N/A	Overhead bin pnl	25	200	N/A	N/A	N/A	N/A	28.0"	21.3"	8.5"	N/A	
486	N/A	N/A	N/A	N/A	Partition pnl	25	200	N/A	N/A	N/A	N/A	16.8"	12.0"	N/A	N/A	
487	N/A	N 23 56 04.740	E 119 40 22.500	Yellow	Fuselage(station 60 to 800)	53	200	600	800	42	23L20R	180.0"	384.0"	N/A	N/A	
488	N/A	N/A	N/A	N/A	Storage bin door	25	200	N/A	N/A	N/A	N/A	34.0"	24.0"	N/A	N/A	
489	N/A	N/A	N/A	N/A	Storage bin cover	25	200	N/A	N/A	N/A	N/A	15.0"	7.0"	N/A	N/A	
490	N/A	N/A	N/A	N/A	Floor pnl with seat track	25	200	N/A	N/A	N/A	N/A	20.0"	16.0"	N/A	N/A	
491	N/A	N/A	N/A	N/A	Floor pnl(two pieces)	25	200	N/A	N/A	N/A	N/A	36.0"	60.0"	N/A	N/A	

492	N/A	N/A	N/A	N/A	25	200	N/A	N/A	N/A	N/A	60.0"	N/A	N/A
493	N/A	N/A	N/A	N/A	25	200	N/A	N/A	N/A	N/A	57.0"	N/A	N/A
494	N/A	N/A	N/A	N/A	25	200	N/A	N/A	N/A	N/A	60.0"	N/A	N/A
495	N/A	N/A	N/A	N/A	25	200	N/A	N/A	N/A	N/A	60.0"	N/A	N/A
496	N/A	N/A	N/A	N/A	25	200	N/A	N/A	N/A	N/A	42.0"	N/A	N/A
497	N/A	N/A	N/A	N/A	25	200	N/A	N/A	N/A	N/A	31.0"	N/A	N/A
498	N/A	N/A	N/A	N/A	25	200	N/A	N/A	N/A	N/A	48.0"	N/A	N/A
499	N/A	N/A	N/A	N/A	25	200	N/A	N/A	N/A	N/A	40.0"	N/A	N/A
500	N/A	N/A	N/A	N/A	25	200	N/A	N/A	N/A	N/A	39.0"	N/A	N/A
501	N/A	N/A	N/A	N/A	25	200	N/A	N/A	N/A	N/A	60.0"	N/A	N/A
502	N/A	N/A	N/A	N/A	25	200	N/A	N/A	N/A	N/A	60.0"	N/A	N/A
503	N/A	N/A	N/A	N/A	25	200	N/A	N/A	N/A	N/A	11.0"	N/A	N/A
504	N/A	N/A	N/A	N/A	25	200	N/A	N/A	N/A	N/A	33.0"	N/A	N/A
505	N/A	N/A	N/A	N/A	53	200	N/A	N/A	N/A	N/A	30.0"	N/A	N/A
506	N/A	N/A	N/A	N/A	57	500	N/A	N/A	N/A	N/A	102.0"	N/A	N/A
507	N/A	N/A	N/A	N/A	34	100	N/A	N/A	N/A	N/A	58.0"	N/A	N/A
508	N/A	N/A	N/A	N/A	29	400	N/A	N/A	N/A	N/A	N/A	N/A	N/A
509	N/A	N/A	N/A	N/A	25	200	N/A	N/A	N/A	N/A	103.0"	N/A	N/A
510	N/A	N/A	N/A	N/A	25	200	N/A	N/A	N/A	N/A	50.0"	N/A	N/A
511	N/A	N/A	N/A	N/A	25	200	N/A	N/A	N/A	N/A	43.0"	N/A	N/A
512	N/A	N/A	N/A	N/A	25	200	N/A	N/A	N/A	N/A	39.0"	N/A	N/A
513	N/A	N/A	N/A	N/A	53	200	N/A	N/A	N/A	N/A	45.0"	N/A	N/A
514	N/A	N/A	N/A	N/A	25	200	N/A	N/A	N/A	N/A	45.0"	N/A	N/A
515	N/A	N/A	N/A	N/A	25	200	N/A	N/A	N/A	N/A	140.0"	N/A	N/A
516	N/A	N/A	N/A	N/A	26	200	N/A	N/A	N/A	N/A	39.0"	N/A	N/A
517	N/A	N/A	N/A	N/A	25	200	N/A	N/A	N/A	N/A	N/A	N/A	N/A
518	N/A	N/A	N/A	N/A	25	200	N/A	N/A	N/A	N/A	30.0"	N/A	N/A
519	N/A	N/A	N/A	N/A	25	200	N/A	N/A	N/A	N/A	12.0"	N/A	N/A
520	N/A	N/A	N/A	N/A	25	200	N/A	N/A	N/A	N/A	32.0"	N/A	N/A
521	N/A	N/A	N/A	N/A	25	200	N/A	N/A	N/A	N/A	34.0"	N/A	N/A
522	N/A	N/A	N/A	N/A	25	200	N/A	N/A	N/A	N/A	28.0"	N/A	N/A
523	N/A	N/A	N/A	N/A	25	200	N/A	N/A	N/A	N/A	50.0"	N/A	N/A
524	N/A	N/A	N/A	N/A	25	200	N/A	N/A	N/A	N/A	36.0"	N/A	N/A
525	N/A	N/A	N/A	N/A	53	200	N/A	N/A	N/A	N/A	60.0"	N/A	N/A
526	N/A	N 23 58 04 680	E 119 40 22 320	Yellow	57	600	1700	N/A	N/A	N/A	35.0"	N/A	No longer exists, cut into 526C1 to C4
527	N/A	N/A	N/A	N/A	25	200	N/A	N/A	N/A	N/A	76.0"	N/A	N/A
528	N/A	N/A	N/A	N/A	25	200	N/A	N/A	N/A	N/A	25.0"	N/A	N/A
529	N/A	N 23 58 54 000	E 119 41 24 000	Red	25	200	N/A	N/A	N/A	N/A	12.0"	N/A	N/A
530	N/A	N 23 58 54 000	E 119 41 24 000	Red	25	200	N/A	N/A	N/A	N/A	84.0"	N/A	N/A
531	N/A	N 23 58 54 000	E 119 41 24 000	Red	25	200	N/A	N/A	N/A	N/A	35.0"	N/A	N/A
532	N/A	N 23 58 54 000	E 119 41 24 000	Red	25	200	N/A	N/A	N/A	N/A	12.0"	N/A	N/A
533	N/A	N 23 58 54 000	E 119 41 24 000	Red	25	200	N/A	N/A	N/A	N/A	24.0"	N/A	N/A
534	N/A	N 23 58 54 000	E 119 41 24 000	Red	25	200	N/A	N/A	N/A	N/A	23.0"	N/A	N/A
535	N/A	N/A	N/A	N/A	21	100	N/A	N/A	N/A	N/A	78.0"	N/A	N/A
536	N/A	N/A	N/A	N/A	25	100	N/A	N/A	N/A	N/A	N/A	N/A	mark as 527
537	N/A	N/A	N/A	N/A	57	500/600	N/A	N/A	N/A	N/A	N/A	N/A	mark as 528
538	N/A	N/A	N/A	N/A	53	100/200	N/A	N/A	N/A	N/A	N/A	N/A	mark as 529
539	N/A	N/A	N/A	N/A	53	100/200	N/A	N/A	N/A	N/A	N/A	N/A	mark as 530
540	N/A	N/A	N/A	N/A	25	100	N/A	N/A	N/A	N/A	N/A	N/A	mark as 531
541	N/A	N/A	N/A	N/A	57	600	N/A	N/A	N/A	N/A	N/A	N/A	mark as 532
542	N/A	N/A	N/A	N/A	53	200	N/A	N/A	N/A	N/A	N/A	N/A	mark as *542
543	N/A	N/A	N/A	N/A	54	400	N/A	N/A	N/A	N/A	N/A	N/A	mark as *543
544	N/A	N/A	N/A	N/A	53	100/200	N/A	N/A	N/A	N/A	N/A	N/A	mark as *544/Dassault Aviation Engine Part mark as *545

545	N/A	N 23 58 04.380	E 119 40 22.800	Yellow	Cockpit	53	200	250	450	41	18L/15R	200.0"	240.0"	N/A	N/A
546	N/A	N 23 58 04.380	E 119 40 22.800	Yellow	Left Wing Gear with partial Fuselage Fuselage LH 3 Door with 3 Frame	32	700	960	1400	44	N/A	N/A	N/A	N/A	N/A
547	N/A	N/A	N/A	N/A	Left Wing	57	500	N/A	N/A	N/A	N/A	N/A	N/A	N/A	N/A
548	N/A	N/A	N/A	N/A	Wing Stringer	57	500/600	N/A	N/A	N/A	N/A	N/A	N/A	N/A	N/A
549	N/A	N/A	N/A	N/A	Center Tank lower skin PNL with Partial front beam across heel beam	53	100	N/A	N/A	N/A	N/A	N/A	N/A	N/A	N/A
550	N/A	N 23 57 33.960	E 119 39 52.140	Green	#4 Engine	70	400	N/A	N/A	N/A	N/A	N/A	N/A	N/A	N/A
551	N/A	N 23 57 18.000	E 119 38 52.440	Green	Nose Cowl	70	400	N/A	N/A	N/A	N/A	N/A	N/A	N/A	N/A
552	N/A	N 23 57 38.340	E 119 39 20.580	Green	Tail Pipe	70	400	N/A	N/A	N/A	N/A	N/A	N/A	N/A	N/A
553	N/A	N/A	N/A	N/A	Fuel Filter	70	400	N/A	N/A	N/A	N/A	N/A	N/A	N/A	N/A
554	N/A	N 23 57 34.380	E 119 39 52.440	Green	Reverser Track ASSY	70	400	N/A	N/A	N/A	N/A	N/A	N/A	N/A	N/A
555	N/A	N 23 57 34.380	E 119 39 52.440	Green	Angle Gear Box	70	400	N/A	N/A	N/A	N/A	N/A	N/A	N/A	N/A
556	N/A	N 23 57 34.380	E 119 39 52.440	Green	Main Gear Box	70	400	N/A	N/A	N/A	N/A	N/A	N/A	N/A	N/A
557	N/A	N/A	N/A	N/A	ADP	29	400	N/A	N/A	N/A	N/A	N/A	N/A	N/A	N/A
558	N/A	N 23 57 34.380	E 119 39 52.440	Green	Fuel Pump P/N:70501-37-3634 S/N:2384A	70	400	N/A	N/A	N/A	N/A	N/A	N/A	N/A	N/A
559	N/A	N/A	N/A	N/A	Case Drain Module	29	400	N/A	N/A	N/A	N/A	N/A	N/A	N/A	N/A
560	N/A	N/A	N/A	N/A	Engine Pneumatic Duct	70	400	N/A	N/A	N/A	N/A	N/A	N/A	N/A	N/A
561	N/A	N 23 57 34.320	E 119 39 51.840	Green	CSD	24	400	N/A	N/A	N/A	N/A	N/A	N/A	N/A	N/A
562	N/A	N/A	N/A	N/A	Reverse Drive Machinzen	78	400	N/A	N/A	N/A	N/A	N/A	N/A	N/A	N/A
563	N/A	N/A	N/A	N/A	Eng inlet cowl	70	400	N/A	N/A	N/A	N/A	N/A	N/A	N/A	N/A
564	N/A	N 25 57 38.340	E 119 39 20.580	none	Eng Fan Case P/N 803402 S/N JK9554	70	400	N/A	N/A	N/A	N/A	N/A	N/A	N/A	N/A
565	N/A	N/A	N/A	N/A	Left Inlet Cowl	70	400	N/A	N/A	N/A	N/A	N/A	N/A	N/A	N/A
566	N/A	N/A	N/A	N/A	Right Inlet cowl	70	400	N/A	N/A	N/A	N/A	N/A	N/A	N/A	N/A
567	N/A	N/A	N/A	N/A	Wing Leading Edge	57	500/600	N/A	N/A	N/A	N/A	N/A	N/A	N/A	N/A
568	N/A	N 23 57 34.320	E 119 39 50.640	Green	Main Gear Box	70	400	N/A	N/A	N/A	N/A	N/A	N/A	N/A	N/A
569	N/A	N 23 57 34.380	E 119 39 52.440	Green	Eng Thrust Reverse	78	400	N/A	N/A	N/A	N/A	N/A	N/A	N/A	N/A
570	N/A	N/A	N/A	N/A	Eng Part	70	400	N/A	N/A	N/A	N/A	N/A	N/A	N/A	N/A
571	N/A	N/A	N/A	N/A	Eng Fire Loop	26	400	N/A	N/A	N/A	N/A	N/A	N/A	N/A	N/A
572	N/A	N/A	N/A	N/A	Eng Pylon	70	400	N/A	N/A	N/A	N/A	N/A	N/A	N/A	N/A
573	N/A	N/A	N/A	N/A	Eng Case	70	400	N/A	N/A	N/A	N/A	N/A	N/A	N/A	N/A
574	N/A	N/A	N/A	N/A	Eng Parts	70	400	N/A	N/A	N/A	N/A	N/A	N/A	N/A	N/A
575	N/A	N/A	N/A	N/A	Eng Fan ext strut	70	400	N/A	N/A	N/A	N/A	N/A	N/A	N/A	N/A
576	N/A	N/A	N/A	N/A	Eng Heat Exchanger	70	400	N/A	N/A	N/A	N/A	N/A	N/A	N/A	N/A
577	N/A	N/A	N/A	N/A	Eng Nose Cowl rear	70	400	N/A	N/A	N/A	N/A	N/A	N/A	N/A	N/A
578	N/A	N/A	N/A	N/A	Fan Case part	70	400	N/A	N/A	N/A	N/A	N/A	N/A	N/A	N/A
579	N/A	N/A	N/A	N/A	Eng Reverser Drive Frame	78	400	N/A	N/A	N/A	N/A	N/A	N/A	N/A	N/A
580	N/A	N 23 57 38.700	E 119 39 21.180	Green	Eng Tank Pipe Inner	70	400	N/A	N/A	N/A	N/A	N/A	N/A	N/A	N/A
581	N/A	N/A	N/A	N/A	Reverser parts	78	400	N/A	N/A	N/A	N/A	N/A	N/A	N/A	N/A
582	N/A	N/A	N/A	N/A	Eng Fan Cowl upper	70	400	N/A	N/A	N/A	N/A	N/A	N/A	N/A	N/A
583	N/A	N/A	N/A	N/A	Reading Light Assembly	33	200	N/A	N/A	N/A	N/A	N/A	N/A	N/A	N/A
584	N/A	N/A	N/A	N/A	3.5 Bleed Exhaust	70	400	N/A	N/A	N/A	N/A	N/A	N/A	N/A	N/A
585	N/A	N/A	N/A	N/A	Fan Case upper	70	400	N/A	N/A	N/A	N/A	N/A	N/A	N/A	N/A
586	N/A	N/A	N/A	N/A	Window Assy	53	200	N/A	N/A	N/A	N/A	N/A	N/A	N/A	N/A
587	N/A	N/A	N/A	N/A	Landing Gear proximit Sensor Support	32	700	N/A	N/A	N/A	N/A	N/A	N/A	N/A	N/A
588	N/A	N/A	N/A	N/A	Eng Fan Case	70	400	N/A	N/A	N/A	N/A	N/A	N/A	N/A	N/A
589	N/A	N/A	N/A	N/A	3.5 Bleed Exhaust	70	400	N/A	N/A	N/A	N/A	N/A	N/A	N/A	N/A
590	N/A	N/A	N/A	N/A	Eng Fan Reverser	78	400	N/A	N/A	N/A	N/A	N/A	N/A	N/A	N/A
591	N/A	N/A	N/A	N/A	Wing LE	57	500/600	N/A	N/A	N/A	N/A	N/A	N/A	N/A	N/A
592	N/A	N/A	N/A	N/A	Eng Reverser cowl part	78	400	N/A	N/A	N/A	N/A	N/A	N/A	N/A	N/A
593	N/A	N/A	N/A	N/A	Eng FEGV Fan ext guide vane	70	400	N/A	N/A	N/A	N/A	N/A	N/A	N/A	N/A
594	N/A	N/A	N/A	N/A	Eng Fuel Heater	70	400	N/A	N/A	N/A	N/A	N/A	N/A	N/A	N/A
595	N/A	N/A	N/A	N/A	Fan exit	70	400	N/A	N/A	N/A	N/A	N/A	N/A	N/A	N/A
596	N/A	N/A	N/A	N/A	Eng Inlet dome	70	400	N/A	N/A	N/A	N/A	N/A	N/A	N/A	N/A
597	N/A	N/A	N/A	N/A	Eng Nose Cowl	70	400	N/A	N/A	N/A	N/A	N/A	N/A	N/A	N/A

643	N/A	N/A	N/A	N/A	N/A	N/A	RH fuselage skin with #2 Entry Door	53	200	720	860	42	16R/26R	N/A	N/A	N/A	N/A	N/A	Items previously identified as 644-n are now separately numbered as 941 and on
644	N/A	N/A	N/A	N/A	N/A	N/A	A lot of small fuselage part which are putted into wooden box.	53	100	N/A	N/A	N/A	N/A	N/A	N/A	N/A	N/A	N/A	N/A
645	N/A	N/A	N/A	N/A	N/A	N/A	A lot of small parts of main cabin which are putted into wooden box.	25	200	N/A	N/A	N/A	N/A	N/A	N/A	N/A	N/A	N/A	N/A
646	N/A	N/A	N/A	Red	E 119 41 38-409	N/A	Partial fuselage bottom skin	53	100	2350	2460	46/48	38L/51R	N/A	N/A	N/A	N/A	N/A	N/A
647	N/A	N/A	Red	E 119 41 39-301	N/A	N/A	Partial fuselage bottom skin from BS 2480 to 2517	53	100	2480	2571	48	4R/51R	N/A	N/A	N/A	N/A	N/A	N/A
648	N/A	N/A	Red	E 119 41 38-409	N/A	N/A	Partial fuselage skin of Sec.48	53	100	2370	2484	48	N/A	N/A	N/A	N/A	N/A	N/A	N/A
649	N/A	N/A	N/A	N/A	N/A	N/A	N/L/G wheel/strut and partial N/W/W structure	32	100	N/A	N/A	N/A	N/A	N/A	N/A	N/A	N/A	N/A	N/A
650	N/A	N/A	Yellow	E 119 40 21-912	N/A	N/A	Partial fuselage skin B.S. 320 to 480 door R1 fwd to aft vertical door frame	53	200	320	480	41	N/A	N/A	N/A	N/A	N/A	N/A	Ship ID 670
651	2002/7/2	N/A	Yellow	E 119 40 21-757	N/A	N/A	Wing I/e RIB	57	500/600	N/A	N/A	N/A	N/A	N/A	N/A	N/A	N/A	N/A	N/A
652	2002/7/2	N/A	Yellow	E 119 40 21-757	N/A	N/A	Partial fuselage skin Sta. 420 to 500, S-16R to 38R	53	200	420	500	41	N/A	N/A	N/A	N/A	N/A	N/A	Ship ID 689
653	2002/7/2	N/A	Yellow	E 119 40 21-757	N/A	N/A	Wing L/E structure and VCK	57	500/600	N/A	N/A	N/A	N/A	N/A	N/A	N/A	N/A	N/A	Ship ID 671
654	N/A	N/A	N/A	N/A	N/A	N/A	Floor longitudinal beam	53	100	N/A	N/A	N/A	N/A	N/A	N/A	N/A	N/A	N/A	N/A
655	N/A	N/A	Yellow	N/A	N/A	N/A	Partial fus. Bottom skin sta. 250 to 300, S-34L to 41L	53	100	250	300	41	N/A	N/A	N/A	N/A	N/A	N/A	N/A
656	N/A	N/A	Yellow	E 119 40 21-757	N/A	N/A	Partial fus. Skin Sta. 340 to 380, S-23R to -34R	53	100	340	380	41	N/A	N/A	N/A	N/A	N/A	N/A	N/A
657	N/A	N/A	N/A	N/A	N/A	N/A	Partial fus. skin Sta. to , S-19R to -22R	53	100	N/A	N/A	N/A	N/A	N/A	N/A	N/A	N/A	N/A	N/A
658	N/A	N/A	N/A	N/A	N/A	N/A	Wing L/E lower panel	57	500/600	N/A	N/A	N/A	N/A	N/A	N/A	N/A	N/A	N/A	N/A
659	N/A	N/A	Green	E 119 39 20-000	N/A	N/A	Eng case(fan case) partially 15"x64"	71	400	N/A	N/A	N/A	N/A	N/A	N/A	N/A	N/A	N/A	N/A
660	N/A	N/A	Green	E 119 39 20-000	N/A	N/A	Pylon panel 14"x40"	54	400	N/A	N/A	N/A	N/A	14.0"	40.0"	N/A	N/A	N/A	N/A
661	N/A	N/A	Green	E 119 39 20-000	N/A	N/A	Eng side cowl rear rim	54	400	N/A	N/A	N/A	N/A	N/A	N/A	N/A	N/A	N/A	N/A
662	N/A	N/A	Green	E 119 39 20-000	N/A	N/A	Eng nose cowl anti-icing duct 3"x15"with pressure SW/PN 21SN41-5A, S/N B128 and Pressure SW/PN 60B00021-7 S/N V206	71	400	N/A	N/A	N/A	N/A	N/A	3.0"	15.0"	N/A	N/A	N/A
663	N/A	N/A	Green	E 119 39 20-000	N/A	N/A	Eng sleeve angle partially 4"x48" P/N 65B97235-179, S/N 002905	71	400	N/A	N/A	N/A	N/A	N/A	4.0"	48.0"	N/A	N/A	N/A
664	N/A	N/A	Green	E 119 39 20-000	N/A	N/A	Eng sleeve flange 3"x31"	71	400	N/A	N/A	N/A	N/A	N/A	3.0"	31.0"	N/A	N/A	N/A
665	N/A	N/A	Green	E 119 39 20-000	N/A	N/A	Eng case partially 7"x48" at 9 to 10 o'clock position	71	400	N/A	N/A	N/A	N/A	N/A	7.0"	48.0"	N/A	N/A	N/A
666	N/A	N/A	Green	E 119 39 20-000	N/A	N/A	Eng pre-cooler control viv	75	400	N/A	N/A	N/A	N/A	N/A	N/A	N/A	N/A	N/A	N/A
667	N/A	N/A	Green	E 119 39 20-000	N/A	N/A	Eng #8slage check viv assy P/N 65B80100 S/N QADF 933	75	400	N/A	N/A	N/A	N/A	N/A	N/A	N/A	N/A	N/A	N/A
668	N/A	N/A	Green	E 119 39 20-000	N/A	N/A	Parts of gear box of eng	71	400	N/A	N/A	N/A	N/A	N/A	N/A	N/A	N/A	N/A	N/A
669	N/A	N/A	Green	E 119 39 20-000	N/A	N/A	Parts of gear box of eng	71	400	N/A	N/A	N/A	N/A	N/A	N/A	N/A	N/A	N/A	N/A
670	N/A	N/A	Green	E 119 39 20-000	N/A	N/A	Eng blt sys relieve viv P/N 60B90102-9 S/N 1580	N/A	400	N/A	N/A	N/A	N/A	N/A	N/A	N/A	N/A	N/A	N/A
671	N/A	N/A	Green	E 119 39 20-000	N/A	N/A	Eng cowl partially	71	400	N/A	N/A	N/A	N/A	N/A	N/A	N/A	N/A	N/A	N/A
672	N/A	N/A	Green	E 119 39 20-000	N/A	N/A	Main gear box 13"x28"x15"	71	400	N/A	N/A	N/A	N/A	13.0"	28.0"	15.0"	N/A	N/A	N/A
673	N/A	N/A	Green	E 119 39 20-000	N/A	N/A	Parts of gear box	71	400	N/A	N/A	N/A	N/A	N/A	N/A	N/A	N/A	N/A	N/A
674	N/A	N/A	Green	E 119 39 20-000	N/A	N/A	Eng cowl flange	71	400	N/A	N/A	N/A	N/A	N/A	N/A	N/A	N/A	N/A	N/A
675	N/A	N/A	Green	E 119 39 20-000	N/A	N/A	Eng cowl strip	54	400	N/A	N/A	N/A	N/A	N/A	N/A	N/A	N/A	N/A	N/A
676	N/A	N/A	Green	E 119 39 20-000	N/A	N/A	Small parts of eng (one bag)	71	400	N/A	N/A	N/A	N/A	N/A	N/A	N/A	N/A	N/A	N/A
677	N/A	N/A	Green	E 119 39 20-000	N/A	N/A	Fuel supply tube	71	400	N/A	N/A	N/A	N/A	N/A	N/A	N/A	N/A	N/A	N/A
678	N/A	N/A	Green	E 119 39 20-000	N/A	N/A	Fan blade 4EA	71	400	N/A	N/A	N/A	N/A	N/A	N/A	N/A	N/A	N/A	N/A
679	N/A	N/A	Green	E 119 39 20-000	N/A	N/A	Eng case ring partially	71	400	N/A	N/A	N/A	N/A	N/A	N/A	N/A	N/A	N/A	N/A
680	N/A	N/A	Green	E 119 39 20-000	N/A	N/A	Eng sleeve partially	71	400	N/A	N/A	N/A	N/A	N/A	N/A	N/A	N/A	N/A	N/A
681	N/A	N/A	Green	E 119 39 20-000	N/A	N/A	Eng HP bid duct 4"x15"	71	400	N/A	N/A	N/A	N/A	N/A	4.0"	15.0"	N/A	N/A	N/A
682	N/A	N/A	Green	E 119 39 20-000	N/A	N/A	Eng thrust sys control drum	71	400	N/A	N/A	N/A	N/A	N/A	N/A	N/A	N/A	N/A	N/A
683	N/A	N/A	Green	E 119 39 20-000	N/A	N/A	Eng strut partially - cowl latch support	54	400	N/A	N/A	N/A	N/A	N/A	N/A	N/A	N/A	N/A	N/A

725	2002/7/11	N 23 58 03.909	E 119 40 22.464	Yellow	WING CENT. SEC. LWR SKIN(L/H)	57	100	1000	1060	44	N/A	140.0"	50.0"	N/A	N/A
726	2002/7/11	N 23 58 11.022	E 119 40 20.523	Yellow	WING CENT. SEC. FRONT SPAR BLKHD	57	100	1000	1000	42/44	N/A	120.0"	70.0"	N/A	N/A
727	2002/7/11	N 23 58 03.747	E 119 40 21.927	Yellow	MOST FWD UPPER WING & SKIN (RH)	57	600	N/A	N/A	N/A	N/A	36.0"	44.0"	N/A	N/A
728	2002/7/11	N 23 58 03.909	E 119 40 22.464	Yellow	LH FUSELAGE SKIN	53	200	520	660	42	N/A	140.0"	270.0"	N/A	N/A
729	2002/7/11	N 23 58 11.022	E 119 40 20.523	Yellow	L/E FWD SPAR PARTIAL	57	500/600	N/A	N/A	N/A	N/A	40.0"	35.0"	N/A	N/A
730	2002/7/11	N 23 58 11.022	E 119 40 20.523	Yellow	LWR COMP	53	100	680	740	N/A	N/A	72.0"	80.0"	N/A	N/A
731	2002/7/11	N 23 58 09.536	E 119 40 18.386	Yellow	UPPER FUSELAGE WITH BEACON LT ASSY	53	200	520	600	42	N/A	140.0"	270.0"	N/A	N/A
732	2002/7/12	N/A	N/A	N/A	WOOD BOX WITH A LOT PIECES	N/A	N/A	N/A	N/A	N/A	N/A	N/A	N/A	N/A	N/A
733	2002/7/12	N/A	N/A	N/A	CENTER FUEL TANK INSIDE FRAME P/N:65801050-116	57	100	N/A	WS411.4 2	N/A	N/A	72.0"	90.0"	30.0"	N/A
734	2002/7/12	N/A	N/A	N/A	E/E COMP C/B PNL & WIRING	53	100	N/A	N/A	N/A	N/A	N/A	N/A	N/A	N/A
735	2002/7/12	N/A	N/A	N/A	FUEL TANK FRAME	57	500/600	N/A	WS499.0 2	N/A	N/A	36.0"	50.0"	N/A	N/A
736	2002/7/12	N/A	N/A	N/A	FUEL TANK FRAME	57	500/600	N/A	WS499.0 2	N/A	N/A	34.0"	54.0"	N/A	N/A
737	2002/6/17	N 23 58 04.680	E 119 40 22.320	Yellow	RH FUSELAGE SKIN WITH DRAG SPLICE FITTINGS	53	100	950	1000	42	N/A	50.0"	20.0"	N/A	N/A
738	2002/7/14	N 23 59 31.600	E 119 43 07.800	Red	L4 DOOR FRAME WITH PARTIAL L/H FUSELAGE SKIN	53	100/200	1580	1920	46	6L/38L	N/A	N/A	N/A	N/A
739	2002/7/14	N 23 58 52.000	E 119 41 48.600	Red	MAIN DECK SEAT TRACK INTERCOSTAL LBL 33.99 (P/N 65823461-2)	53	200	1540	1600	46	N/A	67.0"	3.0"	3.0"	N/A
740	2002/7/14	N 23 59 07.300	E 119 44 04.600	Red	STA 2040 CARGO FLOOR FRAME S-42R-50L	53	100	2040	2040	46	50L/42R	64.0"	16.0"	N/A	N/A
741	2002/7/14	N 23 58 21.800	E 119 41 30.100	Red	AFT CGO LOADING PANEL WITH PARTIAL CGO DOOR P/N 2358218	53	100	1741.1	1910	46	29R/50R	N/A	N/A	N/A	N/A
742	2002/7/15	N 24 02 22.400	E 119 37 33.300	none	GOVERNOR UNIT/OIL PUMP DRY FOR STRUT MOUNTED ADP	29	500/600	N/A	N/A	N/A	N/A	N/A	N/A	N/A	N/A
743	2002/7/15	N 24 02 22.400	E 119 37 33.300	none	L/H T/E FLAP OUTBD MID FLAP	57	500	N/A	N/A	N/A	N/A	N/A	N/A	N/A	N/A
744	2002/7/15	N 24 02 22.400	E 119 37 33.300	none	SEAT TRACK	53	200	N/A	N/A	N/A	N/A	96.0"	N/A	N/A	N/A
745	2002/7/15	N 24 02 22.400	E 119 37 33.300	Blue	FUSELAGE FRAME	53	200	1500	1500	46	12L/16L	55.0"	N/A	N/A	N/A
746	2002/7/15	N 24 02 22.400	E 119 37 33.300	none	ENG INLET COWL P/N 65891521-2	70	400	N/A	N/A	N/A	N/A	60.0"	24.0"	N/A	N/A
747	2002/7/15	N 24 02 22.400	E 119 37 33.300	none	INLET COWL/ACOUSTIC PNL	70	400	N/A	N/A	N/A	N/A	48.0"	20.0"	N/A	N/A
748	2002/7/15	N 24 02 22.400	E 119 37 33.300	none	DR 3 OFF WING SLIDE INFLATION PRESS VESSEL	25	200	N/A	N/A	N/A	N/A	N/A	N/A	N/A	N/A
749	2002/7/15	N 24 02 22.400	E 119 37 33.300	none	PORTABLE OXY CYLINDER P/N 60B50087-35	25	200	N/A	N/A	N/A	N/A	N/A	N/A	N/A	N/A
750	2002/7/15	N 23 59 05.851	E 119 41 51.781	Red	CAB SEAT (448BC)	25	200	N/A	N/A	N/A	N/A	N/A	N/A	N/A	N/A
751	2002/7/15	N 23 59 05.851	E 119 41 51.781	Red	5L DOOR & FUSELAGE SKIN	53	200	2120	2230	46	16L/26L	110.0"	100.0"	N/A	S17L to 25L
751-1	2002/10/29	N 23 59 05.851	E 119 41 51.781	Red	STA 2200 FRAME SEGMENT	53	200	2200	2200	46	18L/20L	N/A	N/A	N/A	ITEM WAS ORIGINALLY PART OF ITEM 751 BUT WAS DETACHED DURING RECOVERY OR TRANSPORT
752	2002/7/16	N 24 02 22.400	E 119 37 33.300	none	ADP BLEED SHUT OFF VLV	54	500/600	N/A	N/A	N/A	N/A	N/A	N/A	N/A	N/A
753	2002/7/16	N 24 02 22.400	E 119 37 33.300	none	SEAT 1EA (E CLASS)	25	200	N/A	N/A	N/A	N/A	N/A	N/A	N/A	N/A
754	2002/7/16	N 24 02 22.400	E 119 37 33.300	none	SEAT 2EA (E CLASS)	25	200	N/A	N/A	N/A	N/A	N/A	N/A	N/A	N/A
755	2002/7/16	N 24 02 22.400	E 119 37 33.300	none	PACK INLET DOOR LIP	21	100	875	875	N/A	N/A	19.0"	12.0"	N/A	Recovered by Fisherman
756	2002/7/17	N 23 59 50.000	E 119 39 50.000	Red	ENG STARTER WH/TUBE	70	400	N/A	N/A	N/A	N/A	N/A	N/A	N/A	Recovered by Fisherman
757	2002/7/17	N 23 59 50.000	E 119 39 50.000	Red	VENT DUCT ASSY 65841908-13	36	100	1180	1180	N/A	N/A	N/A	N/A	N/A	Recovered by Fisherman
758	2002/7/17	N 23 57 40.000	E 119 38 00.000	Green	ACOUSTIC PNL	72	400	N/A	N/A	N/A	N/A	N/A	N/A	N/A	Recovered by Fisherman
759	2002/7/17	N 23 57 40.000	E 119 38 00.000	Green	ENG COWL LATCH & SUPPORT	72	400	N/A	N/A	N/A	N/A	N/A	N/A	N/A	Recovered by Fisherman
760	2002/7/17	N 23 57 40.000	E 119 38 00.000	Green	ENG PYLON FITTING #2	72	400	N/A	N/A	N/A	N/A	N/A	N/A	N/A	Recovered by Fisherman
761	2002/7/17	N 23 57 40.000	E 119 38 00.000	Green	ENG COWL FLANGE #2	72	400	N/A	N/A	N/A	N/A	N/A	N/A	N/A	Recovered by Fisherman

847	2002/7/30	N 23 58 03.682	E 119 40 22.750	Yellow	FRAME SEGMENT (CLIP P/N:65B-38600-143/-154...) FUSELAGE SKIN	53	100/200	820	820	42	5L4R	N/A	N/A	N/A	N/A	N/A
848	2002/7/30	N/A	N/A	N/A	FUSELAGE SKIN	53	100/200	N/A	N/A	N/A	N/A	N/A	N/A	N/A	N/A	N/A
849	2002/7/30	N 23 58 03.682	E 119 40 22.750	Yellow	FUSELAGE COMPONENT	53	100/200	N/A	N/A	N/A	N/A	N/A	N/A	N/A	N/A	N/A
850	2002/7/30	N/A	N/A	N/A	FUSELAGE COMPONENT	53	100/200	N/A	N/A	N/A	N/A	N/A	N/A	N/A	N/A	N/A
851	2002/7/30	N 23 58 03.682	E 119 40 22.750	Yellow	FRAME SEGMENT	57	500/600	N/A	N/A	N/A	N/A	N/A	N/A	N/A	N/A	N/A
852	2002/7/30	N/A	N/A	N/A	WING SEGMENT	57	500/600	N/A	N/A	N/A	N/A	N/A	N/A	N/A	N/A	N/A
853	2002/8/1	N/A	N/A	N/A	CABIN INTERIOR	25	200	N/A	N/A	N/A	N/A	N/A	N/A	N/A	N/A	N/A
854	2002/8/2	N/A	N/A	N/A	LH INBD T/E AFT FLAP SEGMENT	57	500/600	N/A	N/A	N/A	N/A	N/A	N/A	N/A	N/A	N/A
855	2002/8/2	N/A	N/A	N/A	ENG SIDE COWL	54	400	N/A	N/A	N/A	N/A	N/A	N/A	N/A	N/A	N/A
856	2002/8/2	N 23 57 32.070	E 119 40 01.876	Green	UNIDENTIFIED SKIN PIECE	53	N/A	N/A	N/A	N/A	N/A	N/A	N/A	N/A	N/A	N/A
857	2002/8/2	N/A	N/A	N/A	COWLING SEGMENT	54	400	N/A	N/A	N/A	N/A	N/A	N/A	N/A	N/A	N/A
858	2002/8/2	N/A	N/A	N/A	PYLON SKIN SEGMENT	54	400	N/A	N/A	N/A	N/A	N/A	N/A	N/A	N/A	N/A
859	2002/8/2	N/A	N/A	N/A	PYLON SKIN SEGMENT	54	400	N/A	N/A	N/A	N/A	N/A	N/A	N/A	N/A	N/A
					WOODEN BOX (ENG. PYLON COMP.)	54	400	N/A	N/A	N/A	N/A	N/A	N/A	N/A	N/A	N/A
860	2002/8/2	N/A	N/A	N/A	WOODEN BOX (COCKPIT INSTRUMENT PANEL)	31	200	N/A	N/A	N/A	N/A	N/A	N/A	N/A	N/A	N/A
861	2002/8/2	N/A	N/A	N/A	WOODEN BOX (COCKPIT INSTRUMENT PANEL)	31	200	N/A	N/A	N/A	N/A	N/A	N/A	N/A	N/A	N/A
862	2002/8/2	N/A	N/A	N/A	WOODEN BOX (ENG. COMPT. GALLEY PANEL)	54	400/200	N/A	N/A	N/A	N/A	N/A	N/A	N/A	N/A	N/A
863	2002/8/3	N 23 58 04.076	E 119 40 21.822	Yellow	WCS UPPER SKIN	57	500/600	N/A	N/A	N/A	N/A	100.0"	N/A	N/A	N/A	N/A
864	2002/8/3	N/A	N/A	N/A	REAR SPAR WEB RBBL 30 TO 70	57	600	N/A	N/A	N/A	N/A	N/A	N/A	N/A	N/A	N/A
865	2002/8/3	N 23 58 03.908	E 119 40 21.678	Yellow	FUSELAGE SKIN PANEL STA 620 TO 620 LH UPPER DECK	57	200	520	620	42	4L/11L	100.0"	N/A	N/A	N/A	N/A
866	2002/8/3	N 23 58 04.357	E 119 40 22.902	Yellow	LH WING SURGE TANK	57	500	N/A	N/A	N/A	N/A	N/A	N/A	N/A	N/A	N/A
867	2002/8/3	N 23 58 04.000	E 119 40 22.348	Yellow	WCS WEB COMMON TO SPANWISE BEAM #3	57	500/600	N/A	N/A	N/A	N/A	N/A	N/A	N/A	N/A	N/A
868	2002/8/3	N 23 58 03.682	E 119 40 22.750	Yellow	LH #2 DOOR	52	800	N/A	N/A	N/A	N/A	N/A	N/A	N/A	N/A	N/A
869	2002/8/3	N 23 58 03.577	E 119 40 22.832	Yellow	L/E FLAP	57	500/600	N/A	N/A	N/A	N/A	N/A	N/A	N/A	N/A	N/A
870	2002/8/3	N 23 58 05.063	E 119 40 48.776	Yellow	PYLON FWD SEGMENT	54	400	N/A	N/A	N/A	N/A	N/A	N/A	N/A	N/A	N/A
871	2002/8/3	N 23 58 04.027	E 119 40 22.348	Yellow	DIAGONAL BRACE WITH PYLON	54	400	N/A	N/A	N/A	N/A	N/A	N/A	N/A	N/A	N/A
872	2002/8/3	N 23 58 03.577	E 119 40 22.832	Yellow	FLAP TRACK WITH JACK SCREW	57	500/600	N/A	N/A	N/A	N/A	N/A	N/A	N/A	N/A	N/A
873	2002/8/3	N 23 58 03.577	E 119 40 22.832	Yellow	L/E FLAP	57	500/600	N/A	N/A	N/A	N/A	N/A	N/A	N/A	N/A	N/A
874	2002/8/3	N 23 58 04.357	E 119 40 22.902	Yellow	SEC 44 PRESS DECK COMMON TO WHEEL WELL	53	100	N/A	N/A	N/A	N/A	N/A	N/A	N/A	N/A	N/A
875	2002/8/3	N 23 58 04.357	E 119 40 22.902	Yellow	UPPER DECK EMERG. EXIT DOOR	53	800	N/A	N/A	N/A	N/A	N/A	N/A	N/A	N/A	N/A
876	2002/8/3	N 23 58 04.068	E 119 40 22.752	Yellow	FUSELAGE SKIN	53	100	460	520	41	42L40R	N/A	N/A	N/A	N/A	65B-01712
877	2002/8/3	N 23 58 03.577	E 119 40 22.832	Yellow	FLAP TRACK WITH JACK SCREW AND L/E WING RIB 65B14991-1	57	500/600	N/A	N/A	N/A	N/A	N/A	N/A	N/A	N/A	N/A
878	2002/8/3	N 23 58 03.682	E 119 40 22.750	Yellow	WING RIB	57	500/600	N/A	N/A	N/A	N/A	N/A	N/A	N/A	N/A	N/A
879	2002/8/3	N 23 58 03.682	E 119 40 22.752	Yellow	FLAP TRACK WITH FLAP AND JACKSCREW	57	500/600	N/A	N/A	N/A	N/A	N/A	N/A	N/A	N/A	N/A

880	2002/8/3	N 23 58 04.027	E 119 40 22.348	Yellow	FUSELAGE SKIN WITH PRESS. RELIEF VALVE.	53	100	742	790	42	27L39L	N/A	N/A	N/A	N/A
881	2002/8/6	N 23 58 04.015	E 119 40 22.152	Yellow	CGO PALLET PNL	25	100	N/A	N/A	N/A	N/A	N/A	N/A	N/A	N/A
882	2002/8/6	N 23 58 04.015	E 119 40 22.152	Yellow	CGO PALLET PNL	25	100	N/A	N/A	N/A	N/A	N/A	N/A	N/A	N/A
883	2002/8/7	N 23 58 03.381	E 119 40 21.995	Yellow	GALLEY ELEVATOR	25	200	N/A	N/A	N/A	N/A	N/A	N/A	N/A	N/A
884	2002/8/7	N 23 58 04.115	E 119 40 21.985	Yellow	L/E FLAP	57	500/600	N/A	N/A	N/A	N/A	N/A	N/A	N/A	N/A
885	2002/8/7	N 23 58 04.376	E 119 40 23.381	Yellow	T/E FLAP	57	500/600	N/A	N/A	N/A	N/A	N/A	N/A	N/A	N/A
886	2002/8/7	N 23 58 04.076	E 119 40 21.822	Yellow	WHEEL WELL SEG. 65E28286-3	53	100	N/A	N/A	N/A	N/A	N/A	N/A	N/A	N/A
887	2002/8/7	N 23 58 04.076	E 119 40 21.822	Yellow	B/G/M/W SEG 65B07941	53	100	N/A	N/A	N/A	N/A	N/A	N/A	N/A	N/A
888	2002/8/7	N 23 58 04.076	E 119 40 21.822	Yellow	SPOILER WITH ACTUATOR	57	500/600	N/A	N/A	N/A	N/A	N/A	N/A	N/A	N/A
889	2002/8/7	N 23 58 04.076	E 119 40 21.822	Yellow	OUTBD FLAP #12 ROTARY ACTUATOR	57	500/600	N/A	N/A	N/A	N/A	N/A	N/A	N/A	N/A
890	2002/8/7	N 23 58 04.076	E 119 40 21.822	Yellow	W/LG DOOR	53	100	N/A	N/A	N/A	N/A	N/A	N/A	N/A	N/A
891	2002/8/7	N 23 58 04.076	E 119 40 21.822	Yellow	LWR LOBE FUSE SKIN 65B07656-52	53	100	N/A	N/A	N/A	80.0"	48.0"	N/A	N/A	N/A
892	2002/8/7	N/A	N/A	N/A	SEC44 FLOOR BEAM WEB	53	100	N/A	N/A	N/A	170.0"	12.0"	N/A	N/A	N/A
893	2002/8/7	N 23 58 04.027	E 119 40 22.348	Yellow	L/E FLAP TRACK(ROD &WEB)	57	500/600	N/A	N/A	N/A	N/A	N/A	N/A	N/A	N/A
894	2002/8/7	N 23 58 04.076	E 119 40 21.822	Yellow	STA620 FRAME	53	100/200	620	620	N/A	80.0"	8.0"	N/A	N/A	N/A
895	2002/8/7	N 23 58 04.357	E 119 40 22.802	Yellow	WING TO BODY FAIRING BRACKET	53	100	N/A	N/A	N/A	130.0"	3.0"	N/A	N/A	N/A
896	2002/8/7	N 23 58 04.164	E 119 40 21.921	Yellow	NEGATIVE CGO PRESSURE RELIEF DOOR	53	100	N/A	N/A	N/A	N/A	N/A	N/A	N/A	N/A
897	2002/8/7	N/A	N/A	N/A	E/E DOOR	52	100	N/A	N/A	N/A	N/A	N/A	N/A	N/A	N/A
898	2002/8/7	N/A	N/A	N/A	L/E KRUNGER INBD FLAP 6539200-5	57	500/600	N/A	N/A	N/A	N/A	N/A	N/A	N/A	N/A
899	2002/8/8	N/A	N/A	N/A	P29 C/B PNL	53	100	N/A	N/A	N/A	N/A	N/A	N/A	N/A	N/A
900	2002/8/8	N 23 58 04.076	E 119 40 23.822	Yellow	WHEEL WELL STRUCTURE RELEASE HANDLE	53	100	N/A	N/A	N/A	30.0"	45.0"	N/A	N/A	N/A
901	2002/8/8	N 23 58 03.682	E 119 40 22.750	Yellow	STA540 FLOOR STRUCTURE WITH PNL	53	200	N/A	N/A	N/A	N/A	N/A	N/A	N/A	N/A
902	2002/8/8	N 23 58 03.682	E 119 40 22.750	Yellow	T/E FLAP SEG	57	500/600	N/A	N/A	N/A	42.0"	28.0"	N/A	N/A	N/A
903	2002/8/8	N 23 58 04.307	E 119 40 22.902	Yellow	WHEEL WELL DOOR SEG	53	100	N/A	N/A	N/A	45.0"	17.0"	N/A	N/A	N/A
904	2002/8/8	N 23 58 04.076	E 119 40 22.822	Yellow	WING RIB WSS2S 22 P/N:65B01054-85	57	500/600	N/A	N/A	N/A	N/A	N/A	N/A	N/A	N/A
905	2002/8/8	N 23 58 04.357	E 119 40 22.902	Yellow	PYLON SKIN	54	400	N/A	N/A	N/A	N/A	N/A	N/A	N/A	N/A
906	2002/8/8	N/A	N/A	N/A	WING SEG WS469 S20 65B01052	57	500/600	N/A	N/A	N/A	61.0"	37.0"	N/A	N/A	N/A
907	2002/8/8	N 23 58 04.115	E 119 40 22.985	Yellow	CENTER TANK SEG	57	100	N/A	N/A	N/A	45.0"	38.0"	N/A	N/A	N/A
908	2002/8/8	N 23 58 03.682	E 119 40 22.750	Yellow	WING TANK SEGMENT P/N:65B10814-6(131C7)	57	100	N/A	N/A	N/A	N/A	N/A	N/A	N/A	N/A
909	2002/8/8	N 23 58 04.076	E 119 40 21.822	Yellow	#2 MAIN TANK SEGMENT	57	100	N/A	N/A	N/A	N/A	N/A	N/A	N/A	N/A
910	2002/8/8	N 23 58 04.521	E 119 40 22.588	Yellow	WING CENTER SECTION	57	100	N/A	N/A	N/A	N/A	N/A	N/A	N/A	N/A

911	2002/8/8	N 23 58 03.830	E 119 40 22.480	Yellow	FUSELAGE SKIN STA 750-1000	53	200	750	1000	42	14L/34L	250.0"	100.0"	N/A	N/A
912	2002/8/8	N 23 58 04.297	E 119 40 23.189	Yellow	#2 PYLON INBD SKIN	54	400	N/A	N/A	N/A	N/A	N/A	N/A	N/A	N/A
913	2002/8/8	N 23 58 03.830	E 119 40 22.480	Yellow	WING SEGMENT WS294.620	57	500/600	N/A	N/A	N/A	N/A	N/A	N/A	N/A	N/A
914	2002/8/8	N 23 58 04.297	E 119 40 22.189	Yellow	B/G/W/W STRUCTURE P/N69B55920	53	100	1400	1460	N/A	N/A	60.0"	36.0"	N/A	N/A
915	2002/8/8	N 23 58 04.297	E 119 40 23.189	Yellow	#2 PYLON OBD SKIN	54	400	N/A	N/A	N/A	N/A	N/A	N/A	N/A	N/A
916	2002/8/8	N 23 58 04.297	E 119 40 23.189	Yellow	#8 FLAP TRACK	57	500/600	N/A	N/A	N/A	N/A	N/A	N/A	N/A	N/A
917	2002/8/8	N 23 58 04.297	E 119 40 23.189	Yellow	RH INBD FLAP	57	600	N/A	N/A	N/A	N/A	N/A	N/A	N/A	N/A
918	2002/8/8	N 23 58 04.297	E 119 40 23.189	Yellow	OUTBD FLAP	57	500/600	N/A	N/A	N/A	N/A	N/A	N/A	N/A	N/A
919	2002/8/8	N/A	N/A	N/A	L/E F/G FLAP PNL	57	500/600	N/A	N/A	N/A	N/A	N/A	N/A	N/A	N/A
920	2002/8/8	N 23 58 04.297	E 119 40 23.189	Yellow	WING SEGMENT WS353	57	500/600	N/A	N/A	N/A	N/A	13.0"	36.0"	N/A	N/A
921	2002/8/8	N 23 58 04.297	E 119 40 23.189	Yellow	WING SKIN UPPER LEFT WING	57	500/600	N/A	N/A	N/A	N/A	N/A	N/A	N/A	N/A
922	2002/8/8	N 23 58 03.830	E 119 40 22.480	Yellow	SEC 41 LWR LOBE FUSELAGE SKIN	53	100	N/A	N/A	41	N/A	N/A	N/A	N/A	N/A
923	2002/8/9	N/A	N/A	N/A	SEC 41/42 FUSELAGE SKIN	53	200	N/A	N/A	41/42	N/A	N/A	N/A	N/A	N/A
924	2002/8/10	N 23 58 04.027	E 119 40 22.348	Yellow	WING STRUCTURE SEGMENTS(IN WOOD BOX)	57	500/600	N/A	N/A	N/A	N/A	N/A	N/A	N/A	N/A
925	2002/8/10	N 23 58 04.027	E 119 40 22.348	Yellow	RH WING UPPER SKIN SEGMENT	57	600	N/A	N/A	N/A	N/A	70.0"	20.0"	N/A	N/A
926	2002/8/10	N 23 58 04.076	E 119 40 21.822	Yellow	LOWER FUSELAGE SKIN	53	100	510	540	41	43L/46R	64.0"	16.0"	N/A	N/A
927	2002/8/10	N 23 58 04.076	E 119 40 21.822	Yellow	CENTER E/E DOOR	52	100	N/A	N/A	N/A	N/A	N/A	N/A	N/A	N/A
928	2002/8/10	N 23 58 04.076	E 119 40 21.822	Yellow	STRUCTURE SEGMENTS(IN 2 WOOD BOX TAG AS 928-1 & 928-2)	53	100/200	840	900	N/A	N/A	N/A	N/A	N/A	N/A
929	2002/8/11	N/A	N/A	N/A	PACK RAM AIR INLET DOOR	21	100/200	N/A	N/A	N/A	N/A	N/A	N/A	N/A	N/A
930	2002/8/11	N 23 58 04.297	E 119 40 23.189	Yellow	WING STRUCTURE SEGMENTS(IN WOOD BOX)	57	500/600	N/A	N/A	N/A	N/A	N/A	N/A	N/A	N/A
931	2002/8/11	N 23 58 04.297	E 119 40 23.189	Yellow	UPPER OTBD PYLON SKIN	54	400	N/A	N/A	N/A	N/A	55.0"	18.0"	15.0"	N/A
932	2002/8/11	N 23 58 04.297	E 119 40 23.189	Yellow	UPPER OTBD PYLON SKIN	54	400	N/A	N/A	N/A	N/A	40.0"	31.0"	8.0"	N/A
933	2002/8/11	N/A	N/A	N/A	BULKHEAD SEGMENT	53	100	1480	N/A	N/A	N/A	70.0"	8.0"	N/A	N/A
934	2002/8/11	N/A	N/A	N/A	FLOOR BEAM	53	200	N/A	N/A	42	N/A	23.0"	15.0"	10.0"	N/A
935	2002/8/11	N/A	N/A	N/A	FUSELAGE SKIN	53	200	995	1018	42/44	17L/19L	21.0"	20.0"	N/A	N/A
936	2002/8/12	N 23 58 21.000	E 119 41 07.000	Red	STA 1800 INTERCOSTAL AND FLOOR BEAM (RBL 11.33 - RBL98.58)	53	200	1800	1800	46	N/A	77.0"	22.0"	12.0"	N/A
937	2002/8/12	N 23 58 21.000	E 119 41 07.000	Red	STA 1820 FLOOR BEAM SEGMENT (RBL75 - RBL11)	53	200	1820	1820	46	N/A	35.0"	27.0"	12.0"	N/A
938	2002/8/12	N 23 58 47.853	E 119 41 38.301	Red	SKIN SEGMENT (STA 2412-2436, S-36-S-44)	53	100	2390	2440	48	36R/44R	N/A	N/A	N/A	N/A
939	2002/8/12	N 23 59 49.000	E 119 41 38.000	Red	SKIN SEGMENT (STA 2360, S-16R)	53	200	2344	2360	46	15R/16R	19.0"	12.0"	N/A	N/A
940	2002/8/12	N 23 59 49.000	E 119 41 38.000	Red	SKIN SEGMENT (STA 2360, S-13R)	53	200	2360	2360	46/48	13R	21.0"	9.0"	N/A	Tag was shown Item 644.
941	2002/8/12	N 23 58 47.883	E 119 41 38.301	Red	SKIN SEGMENT (STA 2360, S-6R-S-8R)	53	300	2360	2380	48	6R/8R	23.0"	16.0"	N/A	Originally item 644-3. See item 641 detailed description for more info.
942	2002/8/12	N 23 58 40.410	E 119 41 38.000	Red	SKIN SEGMENT (STA 2460-2484, S-24R-S-25R)	53	300	2460	2484	48	24R/25R	37.0"	18.0"	N/A	Originally item 644-6. See item 647 detailed description for more info.
943	2002/8/12	N 23 58 47.880	E 119 41 38.301	Red	SKIN SEGMENT (STA 2412-2436, S-36L-S-42L)	53	300	2412	2436	48	40L/42L	N/A	N/A	N/A	Originally item 644-7. See item 646 detailed description for more info.

944	2002/8/12	N 23 58 48.467	E 119 41 38.409	Red	SKIN SEGMENT (STA 2486-2460, S-23R - S-36R)	53	300	2412	2460	48	23R/36R	N/A	N/A	N/A	N/A	Originally Item 644-5. See Item 647 detailed description for more info.
945	2002/8/12	N/A	N/A	N/A	STRINGER SEGMENT (STRAP 65B04897-2)	53	200	740	N/A	44	16	48.0"	N/A	3.0"	N/A	
946	2002/8/12	N/A	N/A	N/A	STA 2360 BULKHEAD UPPER SEGMENT	53	200	2360	N/A	48/48	N/A	36.0"	N/A	17.0"	N/A	
947	2002/8/12	N/A	N/A	N/A	WLG DOOR SEGMENT	52	100	N/A	N/A	N/A	N/A	32.0"	N/A	20.0"	N/A	
948	2002/8/12	N/A	N/A	N/A	CARGO CONTAINER (A/A60223...JFWID CGO 11L FOR FLT KIT	25	100	N/A	N/A	N/A	N/A	88.0"	N/A	38.0"	N/A	
949	2002/8/12	N/A	N/A	N/A	PNEUMATIC DUCT STA1021-1140.(P/N: 65B43646-3)	36	100	1021	1140	N/A	N/A	1000.0"	N/A	5.0"	N/A	
950	2002/8/12	N/A	N/A	N/A	CARGO LT SUPPORT, STA 602	53	100	602	N/A	N/A	N/A	N/A	N/A	N/A	N/A	
951	2002/8/12	N/A	N/A	N/A	FLOOR BEAM SEGMENT	53	200	N/A	N/A	N/A	N/A	19.0"	N/A	8.0"	N/A	
952	2002/8/12	N/A	N/A	N/A	STA680 FRAME SEGMENT	53	200	880	N/A	N/A	N/A	32.0"	N/A	7.0"	N/A	
953	2002/8/12	N/A	N/A	N/A	PACK DUCT (PLATE, 65B42238-1)	21	100	N/A	N/A	N/A	N/A	58.0"	N/A	17.0"	N/A	
954	2002/8/12	N/A	N/A	N/A	LOWER LOBE FRAME SEGMENT	53	100	N/A	N/A	N/A	N/A	50.0"	N/A	15.0"	N/A	
955	2002/8/12	N/A	N/A	N/A	FLOOR BEAM	53	100	N/A	N/A	N/A	N/A	24.0"	N/A	10.0"	N/A	
956	2002/8/12	N/A	N/A	N/A	LOWER LOBE FRAME SEGMENT	53	100	N/A	N/A	N/A	N/A	16.0"	N/A	14.0"	N/A	
957	2002/8/12	N/A	N/A	N/A	LOWER LOBE FRAME SEGMENT	53	100	N/A	N/A	N/A	N/A	19.0"	N/A	14.0"	N/A	
958	2002/8/12	N/A	N/A	N/A	LOWER LOBE FRAME SEGMENT	53	100	N/A	N/A	N/A	N/A	41.0"	N/A	7.0"	N/A	
959	2002/8/12	N/A	N/A	N/A	DADO PANEL (65B64153-2)	21	200	N/A	N/A	N/A	N/A	14.0"	N/A	13.0"	N/A	
960	2002/8/12	N/A	N/A	N/A	VERTICAL FIN TIP CAP (FROM CHINA)	55	200	2680	2880	N/A	N/A	N/A	N/A	N/A	N/A	
961	2002/8/15	N/A	N/A	N/A	PYLON SKIN	54	400	N/A	N/A	N/A	N/A	N/A	N/A	N/A	N/A	
962	2002/8/15	N/A	N/A	N/A	WING RIB	57	500/600	N/A	N/A	N/A	N/A	N/A	N/A	N/A	N/A	
963	2002/8/15	N 23 58 05.145	E 119 40 22.209	Yellow	WING L/E	57	500/600	N/A	N/A	N/A	N/A	N/A	N/A	N/A	N/A	
964	2002/8/15	N/A	N/A	N/A	WING RIB (65B010530)	57	500/600	N/A	N/A	N/A	N/A	N/A	N/A	N/A	N/A	
965	2002/8/15	N/A	N/A	N/A	WING RIB W/H FUEL LINE	57	500/600	N/A	N/A	N/A	N/A	N/A	N/A	N/A	N/A	
966	2002/8/15	N/A	N/A	N/A	MAIN DECK FLOOR PNL STA 880	53	200	N/A	N/A	N/A	N/A	N/A	N/A	N/A	N/A	
967	2002/8/15	N 23 58 05.145	E 119 40 22.209	Yellow	L/E FLAP 65B83073	57	500/600	N/A	N/A	N/A	N/A	N/A	N/A	N/A	N/A	
968	2002/8/15	N 23 58 04	E 119 40 22	Yellow	FUSELAGE SKIN WITH STA TIC PORT	53	200	660	720	42	28L/36L	N/A	N/A	N/A	N/A	
969	2002/8/15	N 23 58 04.796	E 119 40 22.257	Yellow	Section 42 lower skin	53	100	858	1000	42	44L/44R	142.0"	48.0"	N/A	N/A	Includes keel beam extension fittings
970	2002/8/15	N 23 58 05.145	E 119 40 22.209	Yellow	Section 42 skin panel	53	100	680	745	42	20L/24L	65.0"	30.0"	N/A	N/A	
971	2002/8/15	N 23 58 04.796	E 119 40 22.275	Yellow	FUSELAGE SKIN	53	100	780	820	42	6R/10R	N/A	N/A	N/A	N/A	
972	2002/8/15	N 23 58 04.796	E 119 40 22.257	Yellow	FUSELAGE SKIN WITH FRAME WEB 65B28083-5	53	100	N/A	N/A	N/A	N/A	N/A	N/A	N/A	N/A	
973	2002/8/15	N 23 58 03.796	E 119 40 22.257	Yellow	FUSELAGE SKIN (DIM E ANT #2) STA840	53	100	741	860	42	44L/45R	119.0"	50.0"	N/A	N/A	
974	2002/8/15	N 23 58 05.165	E 119 40 22.209	Yellow	OVERHEAD BIN RACK	25	200	N/A	N/A	N/A	N/A	N/A	N/A	N/A	N/A	
975	2002/8/15	N 23 58 05.145	E 119 40 22.209	Yellow	L/G DOOR	52	100	N/A	N/A	N/A	N/A	N/A	N/A	N/A	N/A	
976	2002/8/15	N/A	N/A	N/A	FUSELAGE SKIN (DIM E ANT #1)	53	100	N/A	N/A	N/A	N/A	N/A	N/A	N/A	N/A	
977	2002/8/17	N/A	N/A	N/A	STRUT SKIN	53	400	N/A	N/A	N/A	N/A	N/A	N/A	N/A	N/A	
978	2002/8/17	N 23 58 04.000	E 119 40 22.000	Yellow	FUSELAGE SKIN STA 460-520, S31R-34R	53	100	450	520	41	31AR/34R	70.0"	40.0"	N/A	N/A	
979	2002/8/17	N/A	N/A	N/A	CARGO COMPARTMENT AC POWER PDU	25	100	N/A	N/A	41	N/A	N/A	N/A	N/A	N/A	
980	2002/8/17	N/A	N/A	N/A	BEAM AT STA980, WL 199	53	100	N/A	N/A	42	N/A	N/A	N/A	N/A	N/A	
981	2002/8/17	N 23 58 04.796	E 119 40 22.257	Yellow	Fuselage Skin	53	100	N/A	N/A	N/A	N/A	N/A	N/A	N/A	N/A	
982	2002/8/17	N 23 58 04.027	E 119 40 22.348	Yellow	SKIN WITH STR	53	100	800	840	42	37R/41R	N/A	N/A	N/A	N/A	
983	2002/8/17	N 23 58 04.796	E 119 40 22.257	Yellow	SKIN WITH STR	53	100	N/A	N/A	N/A	N/A	N/A	N/A	N/A	N/A	

984	2002/8/17	N 23 58 04.796	E 119 40 22.257	Yellow	SKIN WITH STR	53	100	N/A	N/A	N/A	N/A	N/A	N/A	N/A	N/A	N/A	N/A
985	2002/8/17	N/A	N/A	N/A	Dado Vent Box(65B64153-1)	21	200	N/A	N/A	N/A	N/A	N/A	N/A	N/A	N/A	N/A	N/A
986	2002/8/17	N/A	N/A	N/A	Dado Vent Box(65B64153-1)	21	200	N/A	N/A	N/A	N/A	N/A	N/A	N/A	N/A	N/A	N/A
987	2002/8/17	N 23 58 04.796	E 119 40 22.257	Yellow	FUSELAGE SKIN	53	100	280	300	41	28AR34R	N/A	N/A	N/A	N/A	N/A	N/A
988	2002/8/17	N/A	N/A	N/A	Bulkhead	53	100	N/A	N/A	N/A	N/A	N/A	N/A	N/A	N/A	N/A	N/A
989	2002/8/17	N/A	N/A	N/A	Aileron Mechanism Box(65B81509-1)	27	500/600	N/A	N/A	N/A	N/A	N/A	N/A	N/A	N/A	N/A	N/A
990	2002/8/17	N/A	N/A	N/A	Wing L/E Nose Section	57	500/600	N/A	N/A	N/A	N/A	N/A	N/A	N/A	N/A	N/A	N/A
991	2002/8/17	N/A	N/A	N/A	STA1080 FRAME (65B10523-16)	53	100/200	N/A	N/A	N/A	N/A	N/A	N/A	N/A	N/A	N/A	N/A
992	2002/8/17	N/A	N/A	N/A	FLOOR BEAM	53	200	N/A	N/A	N/A	N/A	N/A	N/A	N/A	N/A	N/A	N/A
993	2002/8/17	N 23 58 05.145	E 119 40 22.209	Yellow	FLOOR BEAM	53	200	N/A	N/A	N/A	N/A	N/A	N/A	N/A	N/A	N/A	N/A
994	2002/8/17	N/A	N/A	N/A	Frame Segment(65B38600-1002 Clip)	53	100/200	N/A	N/A	N/A	N/A	N/A	N/A	N/A	N/A	N/A	N/A
995	2002/8/17	N/A	N/A	N/A	FUSELAGE SKIN	53	100/200	N/A	N/A	N/A	N/A	N/A	N/A	N/A	N/A	N/A	N/A
996	2002/8/17	N/A	N/A	N/A	FUSELAGE SKIN	53	100/200	N/A	N/A	N/A	N/A	N/A	N/A	N/A	N/A	N/A	N/A
997	2002/8/18	N/A	N/A	N/A	FUSELAGE SKIN STA300, S-19R-S-25R (PITOT)	53	200	N/A	N/A	N/A	N/A	N/A	N/A	N/A	N/A	N/A	N/A
998	2002/8/19	N 23 58 04.416	E 119 40 22.270	Yellow	Section 41 Bulkhead	53	100	N/A	N/A	N/A	N/A	N/A	N/A	N/A	N/A	N/A	N/A
999	2002/8/19	N 23 58 04.416	E 119 40 22.270	Yellow	L/E VC Flap	27	500/600	N/A	N/A	N/A	N/A	N/A	N/A	N/A	N/A	N/A	N/A
1000	2002/8/19	N 23 58 05.450	E 119 40 22.050	Yellow	Floor Structure	5	200	N/A	N/A	N/A	N/A	N/A	N/A	N/A	N/A	N/A	N/A
1001	2002/8/19	N 23 58 05.450	E 119 40 22.050	Yellow	Galley Panel	25	200	N/A	N/A	N/A	N/A	N/A	N/A	N/A	N/A	N/A	N/A
1002	2002/8/19	N 23 58 05.049	E 119 40 23.731	Yellow	RH T/E AFT Flap	57	500/600	N/A	N/A	N/A	N/A	N/A	N/A	N/A	N/A	N/A	N/A
1003	2002/8/19	N/A	N/A	N/A	Wing L/E Lower Fixed Panel	57	500/600	N/A	N/A	N/A	N/A	N/A	N/A	N/A	N/A	N/A	N/A
1004	2002/8/19	N/A	N/A	N/A	Wing L/E Nose Section	57	500/600	N/A	N/A	N/A	N/A	N/A	N/A	N/A	N/A	N/A	N/A
1005	2002/8/19	N/A	N/A	N/A	WS 294.62 Wing Rib	57	500/600	N/A	N/A	N/A	N/A	N/A	N/A	N/A	N/A	N/A	N/A
1006	2002/8/19	N/A	N/A	N/A	ID Pending	N/A	N/A	N/A	N/A	N/A	N/A	N/A	N/A	N/A	N/A	N/A	N/A
1007	2002/8/19	N/A	N/A	N/A	RH Wing L/E FSSO 1281-1383	57	500/600	N/A	N/A	N/A	N/A	N/A	N/A	N/A	N/A	N/A	N/A
1008	2002/8/19	N/A	N/A	N/A	Wing Stringer Segment	57	500/600	N/A	N/A	N/A	N/A	N/A	N/A	N/A	N/A	N/A	N/A
1009	2002/8/19	N 23 58 04.416	E 119 40 22.270	Yellow	RH Wing Front Spar FSSI 250-304	57	500/600	N/A	N/A	N/A	N/A	N/A	N/A	N/A	N/A	N/A	N/A
1010	2002/8/19	N/A	N/A	N/A	RH #1 Main Entry Door	52	800	N/A	N/A	41	N/A	N/A	N/A	N/A	N/A	N/A	N/A
1011	2002/8/19	N/A	N/A	N/A	Galley Floor Panel	25	200	N/A	N/A	N/A	N/A	N/A	N/A	N/A	N/A	N/A	N/A
1012	2002/8/19	N 23 58 05.049	E 119 40 23.731	Yellow	OB T/E Flap Track	57	500/600	N/A	N/A	N/A	N/A	N/A	N/A	N/A	N/A	N/A	N/A
1013	2002/8/19	N 23 58 05.049	E 119 40 23.731	Yellow	Inboard Aileron	57	500/600	N/A	N/A	N/A	N/A	N/A	N/A	N/A	N/A	N/A	N/A
1014	2002/8/19	N/A	N/A	N/A	OB T/E Flap FWD/MID/AFT	57	500/600	N/A	N/A	N/A	N/A	N/A	N/A	N/A	N/A	N/A	N/A
1015	2002/8/19	N 23 58 05.328	E 119 40 22.148	Yellow	Pressure Deck(STA 1403-1438)	53	100	N/A	N/A	44	N/A	N/A	N/A	N/A	N/A	N/A	N/A
1016	2002/8/19	N 23 58 05.049	E 119 40 23.731	Yellow	RH OB T/E Flap	53	500/600	N/A	N/A	N/A	N/A	N/A	N/A	N/A	N/A	N/A	N/A
1017	2002/8/19	N 23 58 05.188	E 119 40 21.494	Yellow	STA780-940 Fuselage Skin Segment	53	200	780	940	42	2L/13L	N/A	N/A	N/A	N/A	N/A	N/A
1018	2002/8/19	N 23 58 05.328	E 119 40 22.148	Yellow	Wing Skin	57	500/600	N/A	N/A	N/A	N/A	N/A	N/A	N/A	N/A	N/A	N/A
1019	2002/8/19	N 23 58 04.262	E 119 40 22.279	Yellow	Wing Rib Web	57	500/600	N/A	N/A	N/A	N/A	N/A	N/A	N/A	N/A	N/A	N/A
1020	2002/8/19	N 23 58 04.979	E 119 40 22.826	Yellow	Pressure Deck Common to Fuselage Skin	53	100	N/A	N/A	N/A	N/A	N/A	N/A	N/A	N/A	N/A	N/A
1021	2002/8/19	N 23 58 04.979	E 119 40 22.826	Yellow	WS 411-42 Wing Rib	57	500/600	N/A	N/A	N/A	N/A	N/A	N/A	N/A	N/A	N/A	N/A

1022	2002/8/19	N 23 58 04.979	E 119 40 22.826	Yellow	Wing Rib Web	57	500/600	N/A	N/A	N/A	N/A	N/A	N/A	N/A	N/A	N/A	N/A	N/A	N/A
1023	2002/8/19	N 23 58 04.979	E 119 40 22.826	Yellow	Wing Rib	57	500/600	N/A	N/A	N/A	N/A	N/A	N/A	N/A	N/A	N/A	N/A	N/A	N/A
1024	2002/8/19	N 23 58 05.188	E 119 40 21.484	Yellow	Fuselage Skin(STA 480-520, S-12L-S-24L)	53	200	500	41	17R/26R	N/A	N/A	N/A	N/A	N/A	N/A	N/A	N/A	N/A
1025	2002/8/19	N 23 58 05.188	E 119 40 21.494	Yellow	Wing LE Flap	57	500/600	N/A	N/A	N/A	N/A	N/A	N/A	N/A	N/A	N/A	N/A	N/A	N/A
1026	2002/8/19	N 23 58 04.262	E 119 40 22.279	Yellow	Fuselage Skin(STA 134-400, S-34-S-45)	53	100	N/A	41	N/A	N/A	N/A	N/A	N/A	N/A	N/A	N/A	N/A	N/A
1027	2002/8/19	N/A	N/A	N/A	Wing Spar	57	500/600	N/A	N/A	N/A	N/A	N/A	N/A	N/A	N/A	N/A	N/A	N/A	N/A
1028	2002/8/19	N/A	N/A	N/A	Floor Beam 66B70324-13(STA 1000/1480)	53	200	N/A	44	N/A	N/A	N/A	N/A	N/A	N/A	N/A	N/A	N/A	N/A
1029	2002/8/19	N/A	N/A	N/A	Fuselage Skin C/T Structure Box	53	100/200	N/A	N/A	N/A	N/A	N/A	N/A	N/A	N/A	N/A	N/A	N/A	N/A
1030	2002/8/19	N 23 58 05.049	E 119 40 23.731	Yellow	Wing LE Flap	57	500/600	N/A	N/A	N/A	N/A	N/A	N/A	N/A	N/A	N/A	N/A	N/A	N/A
1031	2002/8/19	N/A	N/A	N/A	Fuselage Skin	53	100/200	N/A	N/A	N/A	N/A	N/A	N/A	N/A	N/A	N/A	N/A	N/A	N/A
1032	2002/8/19	N/A	N/A	N/A	Fuselage Skin	53	100/200	N/A	N/A	N/A	N/A	N/A	N/A	N/A	N/A	N/A	N/A	N/A	N/A
1033	2002/8/19	N/A	N/A	N/A	FWD Pressure Bulkhead	53	100	N/A	N/A	N/A	N/A	N/A	N/A	N/A	N/A	N/A	N/A	N/A	N/A
1034	2002/8/19	N 23 58 05.049	E 119 40 23.731	Yellow	Wing LE Flap	57	500/600	N/A	N/A	N/A	N/A	N/A	N/A	N/A	N/A	N/A	N/A	N/A	N/A
1035	2002/8/19	N/A	N/A	N/A	Wing Spar	57	500/600	N/A	N/A	N/A	N/A	N/A	N/A	N/A	N/A	N/A	N/A	N/A	N/A
1036	2002/8/19	N/A	N/A	N/A	WS 353.02 Wing Rib	57	500/600	N/A	N/A	N/A	N/A	N/A	N/A	N/A	N/A	N/A	N/A	N/A	N/A
1037	2002/8/19	N/A	N/A	N/A	Fuselage Skin Lower lobe_Under Fairing	53	100	N/A	N/A	N/A	N/A	N/A	N/A	N/A	N/A	N/A	N/A	N/A	N/A
1038	2002/8/19	N/A	N/A	N/A	WS 382.22 Wing Rib	57	500/600	N/A	N/A	N/A	N/A	N/A	N/A	N/A	N/A	N/A	N/A	N/A	N/A
1039	2002/8/19	N/A	N/A	N/A	Wing Rib	57	500/600	N/A	N/A	N/A	N/A	N/A	N/A	N/A	N/A	N/A	N/A	N/A	N/A
1040	2002/8/19	N/A	N/A	N/A	Fuselage Skin(65B0415(STA 741-1000))	53	100	N/A	42	N/A	N/A	N/A	N/A	N/A	N/A	N/A	N/A	N/A	N/A
1041	2002/8/19	N/A	N/A	N/A	Pylon Skin	54	400	N/A	N/A	N/A	N/A	N/A	N/A	N/A	N/A	N/A	N/A	N/A	N/A
1042	2002/8/19	N/A	N/A	N/A	STA 840 Frame Segment	53	100/200	N/A	N/A	42	N/A	N/A	N/A	N/A	N/A	N/A	N/A	N/A	N/A
1043	2002/8/19	N/A	N/A	N/A	STA 840 Frame Segment	53	100/200	N/A	N/A	42	N/A	N/A	N/A	N/A	N/A	N/A	N/A	N/A	N/A
1044	2002/8/19	N/A	N/A	N/A	Frame Segment	53	100/200	N/A	N/A	N/A	N/A	N/A	N/A	N/A	N/A	N/A	N/A	N/A	N/A
1045	2002/8/19	N/A	N/A	N/A	STA 600 Frame Segment	53	100/200	N/A	N/A	42	N/A	N/A	N/A	N/A	N/A	N/A	N/A	N/A	N/A
1046	2002/8/19	N 23 58 04.262	E 119 40 22.279	Yellow	Wing Rib	57	500/600	N/A	N/A	N/A	N/A	N/A	N/A	N/A	N/A	N/A	N/A	N/A	N/A
1047	2002/8/19	N/A	N/A	N/A	WBL150.0 Wing Rib	57	500/600	N/A	N/A	N/A	N/A	N/A	N/A	N/A	N/A	N/A	N/A	N/A	N/A
1048	2002/8/19	N 23 58 04.416	E 119 40 22.270	Yellow	N1WW Side Panel(65B07942-901)	53	100	260	340	41	N/A	N/A	N/A	N/A	N/A	N/A	N/A	N/A	N/A
1049	2002/8/19	N 23 58 04.262	E 119 40 22.279	Yellow	Upper Deck Slide Platform(69B55448-1)	53	200	N/A	N/A	N/A	N/A	N/A	N/A	N/A	N/A	N/A	N/A	N/A	N/A
1050	2002/8/19	N/A	N/A	N/A	LH T/E AFT Flap	57	500/600	N/A	N/A	N/A	N/A	N/A	N/A	N/A	N/A	N/A	N/A	N/A	N/A
1051	2002/8/19	N 23 58 05.328	E 119 40 22.148	Yellow	RH Upper Deck Slide with Floor Skin	25	200	N/A	N/A	N/A	N/A	N/A	N/A	N/A	N/A	N/A	N/A	N/A	N/A
1052	2002/8/20	N/A	N/A	N/A	Oven Rack	25	200	N/A	N/A	N/A	N/A	N/A	N/A	N/A	N/A	N/A	N/A	N/A	N/A
1053	2002/8/20	N 23 58 05.328	E 119 40 22.148	Yellow	Pressure Deck	53	100	N/A	N/A	N/A	N/A	N/A	N/A	N/A	N/A	N/A	N/A	N/A	N/A
1054	2002/8/20	N/A	N/A	N/A	HF ANT Coupler	23	100	N/A	N/A	N/A	N/A	N/A	N/A	N/A	N/A	N/A	N/A	N/A	N/A
1055	2002/8/20	N 23 58 05.328	E 119 40 22.148	Yellow	Strut T/E Fairing	54	400	N/A	N/A	N/A	N/A	N/A	N/A	N/A	N/A	N/A	N/A	N/A	N/A
1056	2002/8/20	N/A	N/A	N/A	Galley	25	200	N/A	N/A	N/A	N/A	N/A	N/A	N/A	N/A	N/A	N/A	N/A	N/A
1057	2002/8/20	N/A	N/A	N/A	RH Wing Front Spar FSSI 480-574	57	500/600	N/A	N/A	N/A	N/A	N/A	N/A	N/A	N/A	N/A	N/A	N/A	N/A
1058	2002/8/20	N/A	N/A	N/A	Wing Midspar	57	500/600	N/A	N/A	N/A	N/A	N/A	N/A	N/A	N/A	N/A	N/A	N/A	N/A
1059	2002/8/20	N/A	N/A	N/A	T/E MID/AFT Flap	57	500/600	N/A	N/A	N/A	N/A	N/A	N/A	N/A	N/A	N/A	N/A	N/A	N/A
1060	2002/8/20	N/A	N/A	N/A	Fuselage Lower Lobe Skin	53	100	N/A	N/A	N/A	N/A	N/A	N/A	N/A	N/A	N/A	N/A	N/A	N/A
1061	2002/8/20	N/A	N/A	N/A	Wing LE	57	500/600	N/A	N/A	N/A	N/A	N/A	N/A	N/A	N/A	N/A	N/A	N/A	N/A
1062	2002/8/20	N/A	N/A	N/A	T/E Flap Skin Panel	57	500/600	N/A	N/A	N/A	N/A	N/A	N/A	N/A	N/A	N/A	N/A	N/A	N/A
1063	2002/8/20	N/A	N/A	N/A	Fuselage Skin	53	100/200	N/A	N/A	N/A	N/A	N/A	N/A	N/A	N/A	N/A	N/A	N/A	N/A
1064	2002/8/20	N/A	N/A	N/A	Fairing Support	53	100/200	N/A	N/A	N/A	N/A	N/A	N/A	N/A	N/A	N/A	N/A	N/A	N/A
1065	2002/8/20	N/A	N/A	N/A	Fixed Panel Support	57	500/600	N/A	N/A	N/A	N/A	N/A	N/A	N/A	N/A	N/A	N/A	N/A	N/A

1212	2002/8/21	N 23 58 04.040	E 119 40 23.731	Yellow	L/E SEGMENT	57	500/600	N/A	N/A	N/A	N/A	N/A	N/A	N/A	N/A	N/A	N/A	N/A	N/A	N/A
1213	2002/8/21	N 23 58 04.040	E 119 40 23.731	Yellow	WING RIB	57	500/600	N/A	N/A	N/A	N/A	N/A	N/A	N/A	N/A	N/A	N/A	N/A	N/A	N/A
1214	2002/8/21	N 23 58 04.040	E 119 40 23.731	Yellow	FUSELAGE SKIN	53	200	1540	1580	46	4R/8R	N/A	N/A	N/A	N/A	N/A	N/A	N/A	N/A	N/A
1215	2002/8/21	N 23 58 04.040	E 119 40 23.731	Yellow	PNEU GND SEV PORT	53	100	N/A	N/A	N/A	N/A	N/A	N/A	N/A	N/A	N/A	N/A	N/A	N/A	N/A
1216	2002/8/21	N 23 58 04.040	E 119 40 23.731	Yellow	GEAR DOOR	32	100	N/A	N/A	N/A	N/A	N/A	N/A	N/A	N/A	N/A	N/A	N/A	N/A	N/A
1217	2002/8/21	N 23 58 03.891	E 119 40 22.584	Yellow	LIFE RAFTSUPPORT BEAM(65812389-27)	53	1265	1319	N/A	N/A	N/A	N/A	N/A	N/A	N/A	N/A	N/A	N/A	N/A	N/A
1218	2002/8/21	N 23 58 03.891	E 119 40 22.584	Yellow	INBD TRAIL EDGE FLAP	57	500/600	N/A	N/A	N/A	N/A	N/A	N/A	N/A	N/A	N/A	N/A	N/A	N/A	N/A
1219	2002/8/21	N 23 58 03.891	E 119 40 22.584	Yellow	WING RIB	57	500/600	N/A	N/A	N/A	N/A	N/A	N/A	N/A	N/A	N/A	N/A	N/A	N/A	N/A
1220	2002/8/21	N 23 58 03.891	E 119 40 22.584	Yellow	FRAME SEGMENTS	53	100/200	680	700	42	N/A	N/A	N/A	N/A	N/A	N/A	N/A	N/A	N/A	N/A
1221	2002/8/21	N 23 58 03.891	E 119 40 22.584	Yellow	WING TIE FIX STRUCTURE	57	500/600	N/A	N/A	N/A	N/A	N/A	N/A	N/A	N/A	N/A	N/A	N/A	N/A	N/A
1222	2002/8/21	N 23 58 03.891	E 119 40 22.584	Yellow	WING TO BODY FAIRING SUPPORT	53	500/600	N/A	N/A	N/A	N/A	N/A	N/A	N/A	N/A	N/A	N/A	N/A	N/A	N/A
1223	2002/8/21	N 23 58 03.891	E 119 40 22.584	Yellow	PYLON SKIN	54	400	N/A	N/A	N/A	N/A	N/A	N/A	N/A	N/A	N/A	N/A	N/A	N/A	N/A
1224	2002/8/21	N 23 58 03.891	E 119 40 22.584	Yellow	WING SKIN	57	500/600	N/A	N/A	N/A	N/A	N/A	N/A	N/A	N/A	N/A	N/A	N/A	N/A	N/A
1225	2002/8/21	N 23 58 03.891	E 119 40 22.584	Yellow	GEAR DOOR	32	100	N/A	N/A	N/A	N/A	N/A	N/A	N/A	N/A	N/A	N/A	N/A	N/A	N/A
1226	2002/8/21	N 23 58 03.891	E 119 40 22.584	Yellow	GEAR DOOR	32	100	N/A	N/A	N/A	N/A	N/A	N/A	N/A	N/A	N/A	N/A	N/A	N/A	N/A
1227	2002/8/21	N 23 58 04.130	E 119 40 23.230	Yellow	KEEL BEAM	53	100	N/A	N/A	N/A	N/A	N/A	N/A	N/A	N/A	N/A	N/A	N/A	N/A	N/A
1228	2002/8/21	N 23 58 04.130	E 119 40 23.230	Yellow	WING RIB	57	500/600	WS323	N/A	N/A	N/A	N/A	N/A	N/A	N/A	N/A	N/A	N/A	N/A	N/A
1229	2002/8/21	N 23 58 04.130	E 119 40 23.230	Yellow	WING RIB	55	500/600	WS1454	N/A	N/A	N/A	N/A	N/A	N/A	N/A	N/A	N/A	N/A	N/A	N/A
1230	2002/8/21	N 23 58 04.130	E 119 40 23.230	Yellow	BULKHEAD	53	100	1480	N/A	N/A	N/A	N/A	N/A	N/A	N/A	N/A	N/A	N/A	N/A	N/A
1231	2002/8/21	N 23 58 04.130	E 119 40 23.230	Yellow	GEAR DOOR	32	100	N/A	N/A	N/A	N/A	N/A	N/A	N/A	N/A	N/A	N/A	N/A	N/A	N/A
1232	2002/8/21	N 23 58 04.130	E 119 40 23.230	Yellow	FRAME SEGMENT	53	100/200	N/A	N/A	N/A	N/A	N/A	N/A	N/A	N/A	N/A	N/A	N/A	N/A	N/A
1233	2002/8/21	N 23 58 04.130	E 119 40 23.230	Yellow	HYD RETURN MODULE	29	100	N/A	N/A	N/A	N/A	N/A	N/A	N/A	N/A	N/A	N/A	N/A	N/A	N/A
1234	2002/8/21	N 23 58 04.130	E 119 40 23.230	Yellow	TRAIL EDGE FORE-FLAP	57	500/600	N/A	N/A	N/A	N/A	N/A	N/A	N/A	N/A	N/A	N/A	N/A	N/A	N/A
1235	2002/8/21	N 23 58 04.130	E 119 40 23.203	Yellow	INBOARD STRUT LOW DRAG FAIRING	N/A	N/A	N/A	N/A	N/A	N/A	N/A	N/A	N/A	N/A	N/A	N/A	N/A	N/A	N/A
1236	2002/8/21	N 23 58 04.130	E 119 40 23.203	Yellow	WING STRINGER UPPER	57	500/600	N/A	N/A	N/A	N/A	N/A	N/A	N/A	N/A	N/A	N/A	N/A	N/A	N/A
1237	2002/8/21	N 23 58 04.130	E 119 40 23.203	Yellow	T/E MID FLAP	57	500/600	N/A	N/A	N/A	N/A	N/A	N/A	N/A	N/A	N/A	N/A	N/A	N/A	N/A
1238	2002/8/21	N 23 58 04.130	E 119 40 23.203	Yellow	FLOOR BEAM	53	200	N/A	N/A	N/A	N/A	N/A	N/A	N/A	N/A	N/A	N/A	N/A	N/A	N/A
1239	2002/8/21	N/A	N/A	N/A	WING T/E RIB	57	500/600	N/A	N/A	N/A	N/A	N/A	N/A	N/A	N/A	N/A	N/A	N/A	N/A	N/A
1240	2002/8/21	N/A	N/A	N/A	Strut T/E Fairing	54	400	N/A	N/A	N/A	N/A	N/A	N/A	N/A	N/A	N/A	N/A	N/A	N/A	N/A
1241	2002/8/21	N/A	N/A	N/A	WING SKIN	57	500/600	N/A	N/A	N/A	N/A	N/A	N/A	N/A	N/A	N/A	N/A	N/A	N/A	N/A
1242	2002/8/21	N/A	N/A	N/A	WING SKIN	57	500/600	N/A	N/A	N/A	N/A	N/A	N/A	N/A	N/A	N/A	N/A	N/A	N/A	N/A

1243	2002/8/21	N/A	N/A	N/A	N/A	WING FRONT SPAR FSSI 400	57	500/600	N/A	N/A	N/A	N/A	N/A	N/A	N/A	N/A	N/A	N/A
1244	2002/8/21	N/A	N/A	N/A	N/A	WING RIB	57	500/600	N/A	N/A	N/A	N/A	N/A	N/A	N/A	N/A	N/A	N/A
1245	2002/8/21	N/A	N/A	N/A	N/A	FRAME SEG P/N:65B01741-1	53	100	960	42	33L/36L	N/A	N/A	N/A	N/A	N/A	N/A	N/A
1246	2002/8/21	N/A	N/A	N/A	N/A	FRAME SEG	53	100/200	1020	44	N/A	N/A	N/A	N/A	N/A	N/A	N/A	N/A
1247	2002/8/21	N/A	N/A	N/A	N/A	FRAME SEG	53	100/200	1438	44	N/A	N/A	N/A	N/A	N/A	N/A	N/A	N/A
1248	2002/8/21	N/A	N/A	N/A	N/A	FRAME SEG P/N:65B38600-362	53	100/200	N/A	N/A	N/A	N/A	N/A	N/A	N/A	N/A	N/A	N/A
1249	2002/8/21	N/A	N/A	N/A	N/A	Wing Rib P/N:65B01049-86	53	100/200	N/A	N/A	N/A	N/A	N/A	N/A	N/A	N/A	N/A	N/A
1250	2002/8/21	N/A	N/A	N/A	N/A	CENTER WING TANK SPANWISE BEAM	57	100	N/A	N/A	N/A	N/A	N/A	N/A	N/A	N/A	N/A	N/A
1251	2002/8/21	N 23 56 04.130	E 119 40 23.203	Yellow	N/A	CENTER WING UPPER SKIN	57	100	1020	N/A	N/A	N/A	N/A	N/A	N/A	N/A	N/A	N/A
1252	2002/8/21	N 23 56 04.130	E 119 40 23.203	Yellow	N/A	CTR WING TANK P/N:65B01111-9001	57	100	N/A	N/A	N/A	N/A	N/A	N/A	N/A	N/A	N/A	N/A
1253	2002/8/21	N/A	N/A	N/A	N/A	SPANWISE BEAM P/N:65B01051-160	57	100	N/A	N/A	N/A	N/A	N/A	N/A	N/A	N/A	N/A	N/A
1254	2002/8/21	N/A	N/A	N/A	N/A	LWR WING SKIN SIDE BODY JOINT RH	57	100	N/A	N/A	N/A	N/A	N/A	N/A	N/A	N/A	N/A	N/A
1255	2002/8/21	N 23 56 04.049	E 119 40 23.231	Yellow	N/A	WING FRONT SPAR	57	500/600	N/A	N/A	N/A	N/A	N/A	N/A	N/A	N/A	N/A	N/A
1256	2002/8/21	N 23 56 04.049	E 119 40 23.231	Yellow	N/A	CTR WING TANK LWR SKIN	57	100	N/A	N/A	N/A	N/A	N/A	N/A	N/A	N/A	N/A	N/A
1257	2002/8/21	N 23 56 03.891	E 119 40 20.584	Yellow	N/A	CTR WING TANK MID SPAR	57	100	N/A	N/A	N/A	N/A	N/A	N/A	N/A	N/A	N/A	N/A
1258	2002/8/21	N/A	N/A	N/A	N/A	CTR WING TANK MID SPAR	57	100	N/A	N/A	N/A	N/A	N/A	N/A	N/A	N/A	N/A	N/A
1259	2002/8/21	N/A	N/A	N/A	N/A	CTR TANK UPPER SKIN	57	100	N/A	N/A	N/A	N/A	N/A	N/A	N/A	N/A	N/A	N/A
1260	2002/8/21	N/A	N/A	N/A	N/A	L/E FIX PNL	57	500/600	N/A	N/A	N/A	N/A	N/A	N/A	N/A	N/A	N/A	N/A
1261	2002/8/21	N/A	N/A	N/A	N/A	FRAME SEG	53	100/200	1000	N/A	N/A	N/A	N/A	N/A	N/A	N/A	N/A	N/A
1262	2002/8/21	N/A	N/A	N/A	N/A	FLOOR BEAM	53	200	N/A	N/A	N/A	N/A	N/A	N/A	N/A	N/A	N/A	N/A
1263	2002/8/21	N/A	N/A	N/A	N/A	FRAME SEG P/N:65B01739-1	53	100/200	N/A	N/A	N/A	N/A	N/A	N/A	N/A	N/A	N/A	N/A
1264	2002/8/21	N 23 56 03.891	E 119 40 22.584	Yellow	N/A	Wing LH FWD SIDE BODY JOINT	57	100	N/A	N/A	N/A	N/A	N/A	N/A	N/A	N/A	N/A	N/A
1265	2002/8/21	N/A	N/A	N/A	N/A	CTR WING TANK LWR SKIN PNL P/N:65B15267-201	57	100	N/A	N/A	N/A	N/A	N/A	N/A	N/A	N/A	N/A	N/A
1266	2002/8/21	N/A	N/A	N/A	N/A	FRAME SEGMENT P/N:65B38600-170	53	100/200	N/A	N/A	N/A	N/A	N/A	N/A	N/A	N/A	N/A	N/A
1267	2002/8/21	N/A	N/A	N/A	N/A	KEEL BEAM LWR CHORD	53	100	N/A	N/A	N/A	N/A	N/A	N/A	N/A	N/A	N/A	N/A
1268	2002/8/21	N/A	N/A	N/A	N/A	WING T/E FIX STRUT	57	500/600	N/A	N/A	N/A	N/A	N/A	N/A	N/A	N/A	N/A	N/A
1269	2002/8/21	N/A	N/A	N/A	N/A	FRAME SEGMENT P/N:65B2A087-12	53	100/200	N/A	N/A	N/A	N/A	N/A	N/A	N/A	N/A	N/A	N/A
1270	2002/8/21	N/A	N/A	N/A	N/A	BULKHEAD	53	100/200	N/A	N/A	N/A	N/A	N/A	N/A	N/A	N/A	N/A	N/A
1271	2002/8/22	N/A	N/A	N/A	N/A	FORE-BEAM P/N : 69B17213-2	53	100/200	N/A	N/A	N/A	N/A	N/A	N/A	N/A	N/A	N/A	N/A
1272	2002/8/22	N/A	N/A	N/A	N/A	P/N : 65B04913-427	53	100/200	N/A	N/A	N/A	N/A	N/A	N/A	N/A	N/A	N/A	N/A
1273	2002/8/22	N/A	N/A	N/A	N/A	FUSELAGE SKIN	53	100/200	N/A	N/A	N/A	N/A	N/A	N/A	N/A	N/A	N/A	N/A
1274	2002/8/22	N/A	N/A	N/A	N/A	UPPER-DECK SHEAR WEB	53	100/200	N/A	N/A	N/A	N/A	N/A	N/A	N/A	N/A	N/A	N/A
1275	2002/8/22	N/A	N/A	N/A	N/A	P/N : 65B04750-409	N/A	N/A	N/A	N/A	N/A	N/A	N/A	N/A	N/A	N/A	N/A	N/A
1276	2002/8/22	N/A	N/A	N/A	N/A	ID PENDING	N/A	N/A	N/A	N/A	N/A	N/A	N/A	N/A	N/A	N/A	N/A	N/A
1277	2002/8/22	N/A	N/A	N/A	N/A	STUB FRAME P/N : 65B10524-11	N/A	N/A	N/A	N/A	N/A	N/A	N/A	N/A	N/A	N/A	N/A	N/A
1278	2002/8/22	N/A	N/A	N/A	N/A	FRAME SEGMENT	53	100/200	N/A	N/A	N/A	N/A	N/A	N/A	N/A	N/A	N/A	N/A
1279	2002/8/22	N/A	N/A	N/A	N/A	WING RIB	57	500/600	N/A	N/A	N/A	N/A	N/A	N/A	N/A	N/A	N/A	N/A
1280	2002/8/22	N/A	N/A	N/A	N/A	WING RIB	57	500/600	N/A	N/A	N/A	N/A	N/A	N/A	N/A	N/A	N/A	N/A
1281	2002/8/25	N 23 59 06.183	E 119 44 28.598	Red	N/A	FUSELAGE SEGMENT P/N : 65B38600-19	53	200	2080	2160	46	4L/70R	N/A	N/A	N/A	N/A	N/A	N/A
1282	2002/8/25	N 23 59 07.849	E 119 44 18.335	Red	N/A	FRAME SEGMENT STA 2300 LWR LOBE P/N : 65B04352	53	200	2300	2300	46	22R/25R	N/A	N/A	N/A	N/A	N/A	N/A
1283-19																		
99																		
2000	2002/9/4	N/A	N/A	N/A	N/A	PORTION OF STA 2436 FRAMES	53	200	2436	2436	48	21R/17R	N/A	N/A	N/A	N/A	N/A	N/A
2001	N/A	N 23 56 48.738	E 119 41 37.322	N/A	N/A	PORTION OF STA 2340 FRAMES	53	200	2340	2340	46	4L/13L	N/A	N/A	N/A	N/A	N/A	N/A
2002	N/A	N 23 38 48.467	E 119 41 36.409	N/A	N/A	SEC 48 FRAMES	53	100	2412	2412	48	46L/20L	N/A	N/A	N/A	N/A	N/A	N/A
2003	N/A	N/A	N/A	N/A	N/A	SEC 48 FRAMES	53	200	2412	2412	48	20L/13L	N/A	N/A	N/A	N/A	N/A	N/A
2004	N/A	N/A	N/A	N/A	N/A	SEC 48 WITH SKIN FRAGMENT	53	200	2412	2412	48	24R/25R	N/A	N/A	N/A	N/A	N/A	N/A
2005	N/A	N/A	N/A	N/A	N/A	SEC 46 FRAME	53	200	2320	2320	46	8L07R	N/A	N/A	N/A	N/A	N/A	N/A
2006	N/A	N/A	N/A	N/A	N/A	SEC 46 FRAME	53	200	1700	1700	46	10L	N/A	N/A	N/A	N/A	N/A	N/A

2007	N/A	N/A	N/A	N/A	N/A	N/A	N/A	53	100	2320	2340	46	26L	N/A	N/A	N/A	N/A
2008	N/A	N/A	N/A	N/A	N/A	N/A	N/A	53	100	1940	1980	46	N/A	N/A	N/A	N/A	N/A
2009	N/A	N/A	N/A	N/A	N/A	N/A	N/A	53	100	1800	1800	46	32R/39R	N/A	N/A	N/A	N/A
2010	N/A	N/A	N/A	N/A	N/A	N/A	N/A	53	200	2260	2360	46	3R/14R	N/A	N/A	N/A	N/A
2011	2002/10/9	N 23 59 46.262	E 119 43 41.349	N/A	N/A	N/A	N/A	53	200	1900	2080	46	12L/30L	N/A	N/A	N/A	N/A
2012	2002/10/9	N 23 58 58.877	E 119 43 20.836	Red	N/A	N/A	N/A	53	200	2140	2320	46	1L/18L	N/A	N/A	N/A	N/A
2013	2002/10/9	N 23 58 50.915	E 119 41 39.077	Red	N/A	N/A	N/A	53	100	2320	2360	46	34L/40L	N/A	N/A	N/A	N/A
2014	2002/10/9	BOAT #5	N/A	N/A	N/A	N/A	N/A	53	100	2060	2060	46	49L/51L	N/A	N/A	N/A	N/A
2015	2002/10/9	N/A	N/A	N/A	N/A	N/A	N/A	53	100	2100	2100	46	50L/48R	N/A	N/A	N/A	N/A
2016	2002/10/9	N/A	N/A	N/A	N/A	N/A	N/A	53	200	1372	1372	44	17L/20L	N/A	N/A	N/A	N/A
2017	2002/10/9	N 23 58 25.765	E 119 42 12.740	Red	N/A	N/A	N/A	53	100	1760	1760	46	51L/40R	N/A	N/A	N/A	N/A
2018	2002/10/9	N/A	N/A	N/A	N/A	N/A	N/A	53	100	1940	1940	46	45R/48R	N/A	N/A	N/A	N/A
2019	2002/10/9	N 23 59 02.001	E 119 42 18.460	Red	N/A	N/A	N/A	53	100	1883	1920	46	N/A	N/A	N/A	N/A	N/A
2020	2002/10/9	N 23 59 12.020	E 119 42 14.848	Red	N/A	N/A	N/A	52	800	N/A	N/A	46	N/A	N/A	N/A	N/A	N/A
2021	2002/10/9	N 23 58 28.248	E 119 42 27.854	Red	N/A	N/A	N/A	52	800	N/A	N/A	46	N/A	N/A	N/A	N/A	N/A
2022	2002/10/9	N 23 58 18.038	E 119 42 26.913	Red	N/A	N/A	N/A	53	100	1600	1790	46	47L 48L OR 47R	N/A	N/A	N/A	N/A
2023	2002/10/9	N 23 59 43.290	E 119 44 06.100	Red	N/A	N/A	N/A	53	200	1920	1940	46	N/A	N/A	N/A	N/A	N/A
2024	2002/10/9	N 23 59 08.000	E 119 44 04.940	Red	N/A	N/A	N/A	53	200	2160	2220	46	4L/6R	60.0"	90.0"	N/A	N/A
2025	2002/10/9	N 23 59 09.858	E 119 41 03.562	Red	N/A	N/A	N/A	53	100	1540	1540	46	N/A	N/A	N/A	N/A	N/A
2026	2002/10/9	N 23 58 20.791	E 119 42 47.937	Red	N/A	N/A	N/A	53	200	1600	1700	46	N/A	N/A	N/A	N/A	N/A
2027	2002/10/9	N 23 58 70.919	E 119 42 47.748	Red	N/A	N/A	N/A	53	200	N/A	N/A	46	N/A	N/A	N/A	N/A	N/A
2028	2002/10/9	N 23 58 58.013	E 119 41 46.409	Red	N/A	N/A	N/A	25	100	N/A	N/A	N/A	N/A	N/A	N/A	N/A	N/A
2029	2002/10/9	N 23 59 20.700	E 119 41 37.100	Red	N/A	N/A	N/A	25	100	N/A	N/A	N/A	N/A	N/A	N/A	N/A	N/A
2030	2002/10/9	N 23 58 28.248	E 119 42 27.854	Red	N/A	N/A	N/A	53	100	1480	1741	46	12R/40R	N/A	N/A	N/A	N/A
2031	2002/10/9	N 23 58 34.390	E 119 41 01.917	Red	N/A	N/A	N/A	53	200	N/A	N/A	N/A	N/A	N/A	N/A	N/A	N/A
2032	2002/10/9	N/A	N/A	N/A	N/A	N/A	N/A	53	200	2397	2397	48	7L/9L	N/A	N/A	N/A	N/A
2033	2002/10/9	N 23 58 48.234	E 119 41 39.577	Red	N/A	N/A	N/A	53	100/200	2340	2340	46	17L/34L	N/A	N/A	N/A	N/A
2034	2002/10/9	N 23 59 10.045	E 119 42 14.146	Red	N/A	N/A	N/A	53, 52	200	2160	2220	46	14R/26R	N/A	N/A	N/A	N/A
2035	2002/10/14	N 23 59 16.101	E 119 43 29.015	Red	N/A	N/A	N/A	55	300	N/A	N/A	N/A	N/A	N/A	N/A	N/A	N/A
2036	2002/10/14	N/A	N/A	N/A	N/A	N/A	N/A	53	100	N/A	N/A	N/A	N/A	N/A	N/A	N/A	N/A
2037	2002/10/14	N 23 58 04.164	E 119 40 21.921	Yellow	N/A	N/A	N/A	25	200	N/A	N/A	N/A	N/A	N/A	N/A	N/A	N/A
2038	2002/10/14	N/A	N/A	N/A	N/A	N/A	N/A	25	200	N/A	N/A	N/A	N/A	N/A	N/A	N/A	N/A
2039	2002/10/14	N/A	N/A	N/A	N/A	N/A	N/A	25	200	N/A	N/A	N/A	N/A	N/A	N/A	N/A	N/A
2040	2002/10/14	N/A	N/A	N/A	N/A	N/A	N/A	25	200	N/A	N/A	N/A	N/A	N/A	N/A	N/A	N/A
2041	2002/10/14	N/A	N/A	N/A	N/A	N/A	N/A	25	200	N/A	N/A	N/A	N/A	N/A	N/A	N/A	N/A
2042	2002/10/14	N/A	N/A	N/A	N/A	N/A	N/A	25	200	N/A	N/A	N/A	N/A	N/A	N/A	N/A	N/A
2043	2002/10/14	N/A	N/A	N/A	N/A	N/A	N/A	25	200	N/A	N/A	N/A	N/A	N/A	N/A	N/A	N/A
2044	2002/10/14	N/A	N/A	N/A	N/A	N/A	N/A	25	200	N/A	N/A	N/A	N/A	N/A	N/A	N/A	N/A
2045	2002/10/14	N/A	N/A	N/A	N/A	N/A	N/A	53	100/200	N/A	N/A	N/A	N/A	N/A	N/A	N/A	N/A
2046	2002/10/14	N/A	N/A	N/A	N/A	N/A	N/A	53	100/200	N/A	N/A	N/A	N/A	N/A	N/A	N/A	N/A
2047	2002/10/14	N/A	N/A	N/A	N/A	N/A	N/A	53	100/200	N/A	N/A	N/A	N/A	N/A	N/A	N/A	N/A
2048	2002/10/14	N/A	N/A	N/A	N/A	N/A	N/A	53	100/200	N/A	N/A	N/A	N/A	N/A	N/A	N/A	N/A
2049	2002/10/14	N/A	N/A	N/A	N/A	N/A	N/A	53	100/200	N/A	N/A	N/A	N/A	N/A	N/A	N/A	N/A
2050	2002/10/14	N/A	N/A	N/A	N/A	N/A	N/A	53	100	550	550	42	34R/36R	20.0"	14.0"	N/A	N/A
2051	2002/10/14	N/A	N/A	N/A	N/A	N/A	N/A	N/A	N/A	N/A	N/A	N/A	N/A	N/A	N/A	N/A	N/A
2052	2002/10/14	N/A	N/A	N/A	N/A	N/A	N/A	53	100/200	N/A	N/A	N/A	N/A	N/A	N/A	N/A	N/A
2053	2002/10/14	N/A	N/A	N/A	N/A	N/A	N/A	53	100/200	N/A	N/A	N/A	N/A	N/A	N/A	N/A	N/A
2054	2002/10/14	N 23 58 04.027	E 119 40 22.348	Yellow	N/A	N/A	N/A	53	100	840	880	42	31R/35R	N/A	N/A	N/A	N/A
2055	2002/10/14	N/A	N/A	N/A	N/A	N/A	N/A	53	100/200	N/A	N/A	N/A	N/A	N/A	N/A	N/A	N/A
2056	2002/10/14	N/A	N/A	N/A	N/A	N/A	N/A	53	100/200	N/A	N/A	N/A	N/A	N/A	N/A	N/A	N/A

2109	2002/10/16	N 23 58 50.915	E 119 41 39.077	Red	STRINGER SEGMENT	53	200	2360	2460	48	26L	N/A	N/A	N/A
2110	2002/10/16	N/A	No	N/A	STRINGER SEGMENT(65B044)	53	100	1720	1750	46	35R OR 36R	N/A	N/A	N/A
2111	2002/10/16	N/A	No	N/A	RUDDER RIB/RUDDER STA 157.7)	55	300	N/A	N/A	48	N/A	N/A	N/A	N/A
2112	2002/10/16	N/A	No	N/A	FRAME SEGMENT(65B04314-1)	53	100	1540	1540	46	33R/38R	N/A	N/A	N/A
2113	2002/10/16	N/A	N/A	N/A	FRAME SEGMENT LOWER LOBE	53	100	1760	1800	46	N/A	N/A	N/A	N/A
2114	2002/10/16	N 23 58 30.582	E 119 41 54.939	Red	FLOOR BEAM UPPER CHORD	53	100/200	1480	1480	44/46	N/A	N/A	N/A	N/A
2115	2002/10/16	N/A	N/A	N/A	STA1480 BULKHEAD PORTION	53	100	1480	1480	44/46	N/A	N/A	N/A	N/A
2116	2002/10/16	N 23 59 16.419	E 119 44 02.326	Red	Center stowbin support rail assy (65B50088-917)	25	N/A	N/A	N/A	N/A	N/A	N/A	N/A	N/A
2117	2002/10/16	N 23 58 56.013	E 119 41 46.409	Red	CARGO CONTAINER FRAGMENT	25	N/A	N/A	N/A	N/A	N/A	N/A	N/A	N/A
2118	2002/10/16	N 23 58 25.790	E 119 42 36.609	Red	WHEEL WELL BAY SKIN	53	100	N/A	N/A	N/A	N/A	N/A	N/A	N/A
2119	2002/10/16	N 23 59 30.833	E 119 41 25.710	Red	CARGO CONTAINER	25	N/A	N/A	N/A	N/A	N/A	N/A	N/A	N/A
2120	2002/10/16	N 23 58 56.650	E 119 41 06.220	Red	CARGO CONTAINER	25	N/A	N/A	N/A	N/A	N/A	N/A	N/A	N/A
2121	2002/10/16	N 23 58 44.727	E 119 41 02.588	Red	SLIDE PACKBOARD COVER PLATES(2EA)	25	N/A	N/A	N/A	N/A	N/A	N/A	N/A	N/A
2122	2002/10/16	N 23 59 09.056	E 119 42 14.293	Red	STA 2231 FRAME(S-13R-S-14R)	53	200	2231	2231	46	13R/14R	N/A	N/A	N/A
2123	2002/10/16	N 23 59 00.799	E 119 43 59.395	Red	STA 2300 FRAME S-12L-S-13L	53	200	2300	2300	46	12L/13L	N/A	N/A	N/A
2124	2002/10/17	N/A	N/A	N/A	FUSELAGE SKIN (INCLUDE 2 WINDOWS)	53	200	280	320	41	19R/23R	N/A	N/A	N/A
2125	2002/10/17	N/A	N/A	N/A	FUSELAGE SKIN	53	200	N/A	N/A	N/A	24/27	N/A	N/A	N/A
2126	2002/10/18	N 23 58 51.249	E 119 41 37.910	Red	FRAME SEGMENT	53	100/200	N/A	N/A	N/A	N/A	N/A	N/A	N/A
2127	2002/10/22	N/A	N/A	N/A	SEAT TRACK ON FLOOR BEAM	53	200	N/A	N/A	N/A	N/A	N/A	N/A	N/A
2128	2002/10/22	BOAT #8	N/A	N/A	HORIZONTAL STABILIZER RIB	55	300	N/A	N/A	48	N/A	N/A	N/A	N/A
2129	2002/10/22	BOAT #2	E 0 00 18.000	N/A	FLOOR BEAM	53	100/200	N/A	N/A	N/A	N/A	N/A	N/A	N/A
2130	2002/10/22	N/A	N/A	N/A	INBD TIE FLAP	57	500	N/A	N/A	N/A	N/A	N/A	N/A	N/A
2131	2002/10/22	BOAT #2	No	N/A	WING SPAR	57	500/600	N/A	N/A	N/A	N/A	N/A	N/A	N/A
2132	2002/10/22	BOAT #1	E 0 09 29.000	N/A	FUSELAGE SKIN	53	100	880	940	42	41L/44L	N/A	N/A	N/A
2133	2002/10/23	BOAT #8	N/A	N/A	FUSELAGE SKIN	53	200	2240	2360	46	12R/23R	N/A	N/A	N/A
2134	2002/10/23	BOAT #8	E 0 09 29.000	N/A	FUSELAGE SKIN STA 2040-1940 S-12L-8L	53	200	1940	2080	46	8L/20L	N/A	N/A	N/A
2135	2002/10/23	N 23 58 00.000	E 0 19 43 51.000	Red	BODY GEAR DOOR	52	800	N/A	N/A	N/A	N/A	N/A	N/A	N/A
2136	2002/10/23	N 23 58 45.000	E 119 44 21.000	Red	FUSELAGE SKIN STA 1960-2080 S-8L-11R	53	200	1960	2100	46	7L/11R	N/A	N/A	N/A
2137	2002/10/23	BOAT #1	E 0 09 29.000	N/A	RBL WHEEL WEL STA 1240	53	100	1240	1350	44	N/A	N/A	N/A	N/A
2138	2002/10/23	BOAT #2	E 0 10 18.000	N/A	STRINGER SEG	53	100	1740	1900	46	49R	N/A	N/A	N/A
2139	2002/10/23	BOAT #2	E 0 10 18.000	N/A	CGO CONTAINER TRACK	25	N/A	N/A	N/A	N/A	N/A	N/A	N/A	N/A
2140	2002/10/23	BOAT #2/5	E 0 09 29.000	N/A	FUSELAGE SKIN STA 2020-2060 S5L-10L	53	200	2020	2060	46	5L/10L	N/A	N/A	N/A
2141	2002/10/23	BOAT #4	E 0 09 29.000	N/A	STRINGER SEG	53	200	2140	2210	46	2L/5L	N/A	N/A	N/A
2142	2002/10/23	BOAT #5	E 0 09 29.000	N/A	FRAME SEG	53	100/200	N/A	N/A	N/A	N/A	N/A	N/A	N/A
2143	2002/10/23	BOAT #5	E 0 09 29.000	N/A	FRAME SEG	53	200	1520	1520	46	4L/11L	N/A	N/A	N/A
2144	2002/10/23	BOAT #5	N/A	N/A	FRAME SEG	53	100	N/A	N/A	N/A	N/A	N/A	N/A	N/A
2145	2002/10/23	BOAT #5	N/A	N/A	SEAT TRACK ON FLOOR BEAM	53	100	N/A	N/A	N/A	N/A	N/A	N/A	N/A
2146	2002/10/23	BOAT #5	No	N/A	CGO ROLLER TRACK	53	100	N/A	N/A	N/A	N/A	N/A	N/A	N/A
2147	2002/10/23	BOAT #3	E 0 10 06.000	N/A	FRAME SEG	53	100	1840	1840	46	N/A	N/A	N/A	N/A
2148	2002/10/23	BOAT #5	No	N/A	FLOOR BEAM STA 1740	53	100	1740	1740	46	N/A	N/A	N/A	N/A
2149	2002/10/23	BOAT #1	E 0 09 27.000	N/A	WING RIB	57	500/600	N/A	N/A	N/A	N/A	N/A	N/A	N/A
2150	2002/10/23	BOAT #8	E 0 09 28.000	N/A	FRAME SEG P/N:65B0680 SKETCH 10/06	53	200	1900	1900	46	N/A	N/A	N/A	N/A
2151	2002/10/23	BOAT #5	N/A	N/A	DADO PNL	25	200	N/A	N/A	N/A	N/A	N/A	N/A	N/A
2152	2002/10/23	BOAT #3	No	N/A	SEAT TRACK	53	100	N/A	N/A	N/A	N/A	N/A	N/A	N/A
2153	2002/10/23	BOAT #1	E 0 09 27.000	N/A	FUSELAGE SKIN	53	100	N/A	N/A	41	34L/38L	N/A	N/A	N/A
2154	2002/10/23	BOAT #3	N/A	N/A	FRAME WITH STRUCTURE SEG(SKETCHED 09/30)	53	100	2180	2180	46	28L/31L	N/A	N/A	N/A
2155	2002/10/23	BOAT #1	N/A	N/A	FRAME SEG	53	100/200	1880	1880	46	13R/16R	N/A	N/A	N/A
2156	2002/10/23	BOAT #1	E 0 09 27.000	N/A	TIE FLAP FIX PNL	57	500/600	N/A	N/A	N/A	N/A	N/A	N/A	N/A
2157	2002/10/23	BOAT #5	E 0 10 06.000	N/A	FRAME SEG(SKETCHED 10/06)	53	200	1600	1600	46	6L/10L	N/A	N/A	N/A
2158	2002/10/24	BOAT #1	E 0 09 29.000	N/A	FLOOR BEAM	53	100	N/A	N/A	N/A	N/A	N/A	N/A	N/A
2159	2002/10/24	BOAT #1	E 0 09 29.000	N/A	RIB SEG	N/A	N/A	N/A	N/A	N/A	N/A	N/A	N/A	N/A
2160	2002/10/24	BOAT #1	no	N/A	ACCESS PNL	N/A	N/A	N/A	N/A	N/A	N/A	N/A	N/A	N/A
2161	2002/10/24	BOAT #1	N/A	N/A	SEAT TRACK	53	100	N/A	N/A	N/A	N/A	N/A	N/A	N/A
2162	2002/10/24	BOAT #3	E 0 09 29.000	N/A	FRAME SEG STA 2260	53	200	2260	2260	46	9L/13L	N/A	N/A	N/A

2217	2002/10/24	BOAT #8	E 00 10 18.000	N/A	FLOOR BEAM STA 1980 VERTICAL FIN LH SKIN PANEL(AFT OF FRONT SPAR)	53	100	1960	1960	46	N/A	N/A	N/A	N/A	N/A
2218	2002/10/24	BOAT #5	E 00 10 06.000	N/A		55	300	N/A	N/A	N/A	N/A	N/A	N/A	N/A	N/A
2219	2002/10/24	BOAT #8	E 00 10 06.000	N/A	FRAME & STRINGER	53	200	2220	2220	46	4L/R	N/A	N/A	N/A	N/A
2220	2002/10/24	BOAT #8	N/A	N/A	CELLING SUPPORT	53	200	N/A	N/A	N/A	N/A	N/A	N/A	N/A	N/A
2221	2002/10/24	BOAT #2	N/A	N/A	FRAME SEG	53	100/200	1580	1580	46	49L/46R	N/A	N/A	N/A	N/A
2222	2002/10/24	N/A	N/A	N/A	FUSELAGE SKIN	53	100/200	960	980	42	37R/35R	N/A	N/A	N/A	N/A
2223	2002/10/25	BOAT#1	E 00 09 27.000	N/A	T/E FLAP	57	500/600	N/A	N/A	N/A	N/A	N/A	N/A	N/A	N/A
2224	2002/11/11	BOAT#4	E 00 10 18.000	N/A	BULK CARGO FLOOR	53	100	1920	1960	46	N/A	N/A	N/A	N/A	N/A
2225	2002/11/11	BOAT#5	E 00 10 06.000	N/A	BULK CARGO FLOOR	53	100	2080	2160	46	N/A	N/A	N/A	N/A	N/A
2226	2002/11/12	N/A	N/A	N/A	FRAME SEC 46	53	100/200	N/A	N/A	46	N/A	N/A	N/A	N/A	N/A
2227	2002/11/12	N/A	N/A	N/A	FUSELAGE SKIN	53	100/200	N/A	N/A	N/A	N/A	N/A	N/A	N/A	N/A
2228	2002/11/18	N 23 58 03.83	E 119 40 22.480	Yellow	WCS UPPER PANEL	57	N/A	N/A	N/A	N/A	N/A	N/A	N/A	N/A	N/A
2229	2002/11/18	N 23 58 03.682	E 119 40 22.750	N/A	WCS MIDSPAR WEB	57	N/A	N/A	N/A	N/A	N/A	N/A	N/A	N/A	N/A
2230	2002/11/18	N/A	N/A	N/A	WCS SPANWISE BEAM #3	57	N/A	N/A	N/A	N/A	N/A	N/A	N/A	N/A	N/A
2231	2002/11/18	N/A	N/A	N/A	WCS SPANWISE BEAM #3	57	N/A	N/A	N/A	N/A	N/A	N/A	N/A	N/A	N/A
2232	2002/11/18	N 23 58 04.027	E 119 40 22.348	Yellow	WCS SPANWISE BEAM #3	57	N/A	N/A	N/A	N/A	N/A	N/A	N/A	N/A	N/A
2233	2002/11/18	N 23 58 03.891	E 119 40 22.584	Yellow	WCS LOWER PANEL	57	N/A	N/A	N/A	N/A	N/A	N/A	N/A	N/A	N/A
2234	2002/11/18	N 23 58 03.682	E 119 40 22.750	Yellow	WCS SPANWISE BEAM #2	57	N/A	N/A	N/A	N/A	N/A	N/A	N/A	N/A	N/A
2235	2002/11/18	N/A	N/A	N/A	WCS SPANWISE BEAM #2 RIB	57	N/A	N/A	N/A	N/A	N/A	N/A	N/A	N/A	N/A
2236	2002/11/18	N/A	N/A	N/A	WCS SPANWISE BEAM #2 PANEL	57	N/A	N/A	N/A	N/A	N/A	N/A	N/A	N/A	N/A
2237	2002/11/18	N/A	N/A	N/A	WCS FRONT SPAR SEGMENT	57	N/A	N/A	N/A	N/A	N/A	N/A	N/A	N/A	N/A
2238	2002/11/18	N/A	N/A	N/A	WCS FRONT SPAR SEGMENT	57	N/A	N/A	N/A	N/A	N/A	N/A	N/A	N/A	N/A
2239	2002/11/18	N 23 58 03.682	E 119 40 22.750	Yellow	WCS FRONT SPAR TERMINAL FITTING	57	N/A	N/A	N/A	N/A	N/A	N/A	N/A	N/A	N/A
2240	2002/11/18	N/A	N/A	N/A	WCS SPANWISE BEAM SEGMENT	57	N/A	N/A	N/A	N/A	N/A	N/A	N/A	N/A	N/A
2241	2002/11/18	N/A	N/A	N/A	WCS SPANWISE BEAM SEGMENT	57	N/A	N/A	N/A	N/A	N/A	N/A	N/A	N/A	N/A
2242	2002/11/18	N/A	N/A	N/A	WCS SPANWISE BEAM SEGMENT	57	N/A	N/A	N/A	N/A	N/A	N/A	N/A	N/A	N/A
2243	2002/11/18	N/A	N/A	N/A	WCS SPANWISE BEAM SEGMENT	57	N/A	N/A	N/A	N/A	N/A	N/A	N/A	N/A	N/A
2244	2002/11/19	N/A	N/A	N/A	WCS SPANWISE BEAM #2 SEG	57	N/A	N/A	N/A	N/A	N/A	N/A	N/A	N/A	N/A
2245	2002/11/19	N/A	N/A	N/A	WCS SIDEBODY RIB	57	N/A	N/A	N/A	N/A	N/A	N/A	N/A	N/A	N/A
2246	2002/11/19	N/A	N/A	N/A	WCS SPANWISE BEAM #1	57	N/A	N/A	N/A	N/A	N/A	N/A	N/A	N/A	N/A
2247	2002/11/19	N/A	N/A	N/A	WCS MID SPAR	57	N/A	N/A	N/A	N/A	N/A	N/A	N/A	N/A	N/A
2248	2002/11/25	N 23 58 03.000	E 119 40 22.000	Yellow	STA 1480 BULK-HEAD SEG	53	N/A	1480	1480	N/A	N/A	N/A	N/A	N/A	N/A
2249	2003/5/22	N/A	N/A	N/A	NOSE COWL FAIRING(FROM CHINA)	N/A	N/A	N/A	N/A	N/A	N/A	N/A	N/A	N/A	N/A
2250	2003/5/22	N/A	N/A	N/A	FRAME STA 1560(FROM CHINA)	N/A	N/A	1560	1560	N/A	N/A	N/A	N/A	N/A	N/A
2251	2003/5/22	N/A	N/A	N/A	LOWER LOBE FRAME(FROM CHINA)	N/A	N/A	N/A	N/A	N/A	N/A	N/A	N/A	N/A	N/A
2252	2003/5/22	N/A	N/A	N/A	WING RIB WS 469.820(FROM CHINA)	N/A	N/A	WS469.820	WS469.820	N/A	N/A	N/A	N/A	N/A	N/A
2253	2003/5/22	N/A	N/A	N/A	WING RIB WS411(FROM CHINA)	N/A	N/A	WS411	WS411	N/A	N/A	N/A	N/A	N/A	N/A
2254	2003/5/22	N/A	N/A	N/A	FLOOR WEB(FROM CHINA)	N/A	N/A	N/A	N/A	N/A	N/A	N/A	N/A	N/A	N/A
2255	2003/5/22	N/A	N/A	N/A	FLAP SKIN(FROM CHINA)	N/A	N/A	N/A	N/A	N/A	N/A	N/A	N/A	N/A	N/A
2256	2003/5/22	N/A	N/A	N/A	DADO PANEL (FROM CHINA)	N/A	N/A	N/A	N/A	N/A	N/A	N/A	N/A	N/A	N/A
2257	2003/5/22	N/A	N/A	N/A	STA 600 WEB(FROM CHINA)	N/A	N/A	600	600	N/A	N/A	N/A	N/A	N/A	N/A
2258	2003/5/22	N/A	N/A	N/A	PARTIAL FRAME & STRINGER(FROM CHINA)	N/A	N/A	N/A	N/A	N/A	N/A	N/A	N/A	N/A	N/A
2259	2003/5/22	N/A	N/A	N/A	FRAME STA 1960(FROM CHINA)	N/A	N/A	N/A	N/A	N/A	N/A	N/A	N/A	N/A	N/A
2260	2003/5/22	N/A	N/A	N/A	ENG FAIRING (FROM CHINA)	N/A	N/A	N/A	N/A	N/A	N/A	N/A	N/A	N/A	N/A
2261	2003/5/22	N/A	N/A	N/A	FUSELAGE SKIN STA 1920-1980(FROM CHINA)	N/A	N/A	1920	1980	N/A	N/A	N/A	N/A	N/A	N/A
2262	2003/5/22	N/A	N/A	N/A	CABIN STUFF(FROM CHINA)	N/A	N/A	N/A	N/A	N/A	N/A	N/A	N/A	N/A	N/A
2263	2003/8/11	N/A	N/A	N/A	SEAT ASSY (FROM MAI-LIAO)	N/A	N/A	N/A	N/A	N/A	N/A	N/A	N/A	N/A	N/A
2264	2003/8/11	N/A	N/A	N/A	PSU SPEAKER (FROM MAI-LIAO)	N/A	N/A	N/A	N/A	N/A	N/A	N/A	N/A	N/A	N/A

此頁空白

EQUIPMENT QUALITY ANALYSIS REPORT

BOEING COMMERCIAL AIRPLANES

SUBJECT: *Examination of Components Related to the Cabin Pressure Control System.*

IDENTIFICATION: A detailed identification of the submitted parts is listed in their respective, individual sections.

REFERENCE: (a) Telex: B-H200-AB-456-ASI, dated 25 May, 2002.

THE INFORMATION SET FORTH IN THIS REPORT IS THE SOLE PROPERTY OF THE BOEING COMPANY. IT IS BEING PROVIDED TO THE RECIPIENT FOR INFORMATIONAL OR CORRECTIVE ACTION PURPOSES ONLY. ANY OTHER USE OR DISCLOSURE, WITHOUT THE WRITTEN PERMISSION OF THE BOEING COMPANY, IS PROHIBITED.

BACKGROUND:

In support of the Aviation Safety Council (ASC), (Taiwan), and the National Transportation Safety Board (NTSB) investigation into the China Airlines 747-200 accident near Makung, Taiwan on May 25, 2002, a request was made to examine components recovered from the accident site. The initial request for evaluation included the following items: two pressure relief valves, a cabin pressure selector panel, a pack control panel, and the cabin altitude indicator.

SUMMARY:

A detailed examination of all of the components submitted was conducted and documented. The observations were noted in the examination section for each specific component or sub-component with any findings listed. At the request of the Taiwan ASC, the Flight Engineer's oxygen control switch was submitted for further metallurgical analysis. The results of that examination have not yet been received but will be forwarded as an addendum to this report.

All text in blue font is extracted from the original proposed test plan as submitted by the NTSB to the ASC and inserted into this report for reference purposes.

The following is a general list of observations extracted from the detailed examinations contained in this report.

Item A. Flight Engineer's Cabin Pressure Control Selector Panel (module M181):

1. **MODE SELECT** switch was in **MAN** (manual) mode.
2. The **ALTITUDE** tape was delaminated and partially missing.
3. Both **OUTFLOW VALVES** indicators' needles were found detached from their respective internal armature/wiper attachment mechanisms during disassembly.

Item B. Air Conditioning (Pack Control) Panel (module M170):

1. The three **PACK VALVES** switches were in the OFF position.
2. Engine numbers 1 and 2 **BLEED AIR** switches were in the OFF position.
3. Engine numbers 3 and 4 **BLEED AIR** switches were in the ON position.

Item C. Cabin Altitude Pressure Panel (module M188):

1. Cabin Altitude indicator reads 13,765 +/- 5.
2. Cabin Altitude indicator's internal bellows are fractured.
3. Vertical Speed Indicator's needle frozen at 500 FPM.
4. Differential Pressure Indicator needle at less than zero.

Item D. Flight Engineer's Panel (modules M179, M183, M184 & M557):

1. Oxygen control panel, (module M183):
 - a. Passenger **OXY** needle at 700 psi. (was disconnected from its driving rod either during or before disassembly).
 - b. **PASSENGER OXYGEN** control switch in **NORM** position. Switch is functional.
 - c. Switch guard breakaway wire is broken.
 - d. Switch guard is damaged with portion missing.
2. Clock (module M184):
 - a. Clock reads 0722.

Item E. Pressure Relief Valves:

EQA 8814R

1. Both sets of flapper doors (upper and lower for both valves) and some hinge pins are missing. The Lower Pressure Relief Valve was no longer attached to the structure. The structure between the upper and lower valves was buckled outward.
2. It cannot be determined conclusively whether the flapper doors were in the open or closed position at or prior to impact.

COMPONENTS AS RECEIVED:

The following pictures document the components after they were unpackaged at the Boeing Equipment Quality Analysis (EQA) facility. See figures 1 through 5.



Figure 1: Section of Flight Engineer's Panel



Figure 2: Flight Engineer's Cabin Pressure Control Selector Panel



Figure 3: Flight Engineer's Cabin Altitude Pressure Module



Figure 4: Unidentified Items



Figure 5: Pressure Relief Valves

EXAMINATION and TEST RESULTS:

As received, the components were individually identified, photographed and visually and microscopically examined for any anomalies or features of note. Testing was limited to that which is described for the individual sections. For the purposes of this report, the results of the examination and tests are presented per individual component or subcomponent in the following order:

- Item A. Cabin Pressure Control Selector Panel (Module M181) – page 5.
- Item B. Air Conditioning (Pack Control) Panel (Module M170) – page 13.
- Item C. Cabin Altitude Pressure Panel (Module M188) – page 21.
- Item D. Flight Engineers Panel (Modules M179, M183, M184, M557) – page 27.
- Item E. Pressure Relief Valves (Upper and Lower) – page 33.
- Item F. Example Pressure Relief Valve (Hamilton-Sundstrand, supplied for comparison out of their rotatable stock) – page 74.
- Item G. Unidentified Items (not examined during this analysis) – page 78.

EQA 8814R

ITEM A.

Identification: Flight Engineer's Cabin Pressure Control Selector Panel (M181)

Supplier: Hamilton Sundstrand
 Boeing P/N: 60B00025-16
 Supplier P/N: 710298-5
 S/N: DJ19821
 Date Code: F/T 01-07-85
 Model Number: PSL101-1
 Modification Number: P19/26
 Boeing Module Number: M181

* Note1: Part names were taken from the Hamilton Sundstrand Overhaul Manual # 21-31-01 Revision, April 1, 2002. Panel descriptions and module numbers were taken from the Boeing 65B46006 drawing (description of the Flight Engineer's Panels). The following diagram, Figure 6, shows a comparative representation of the face of a reference panel.

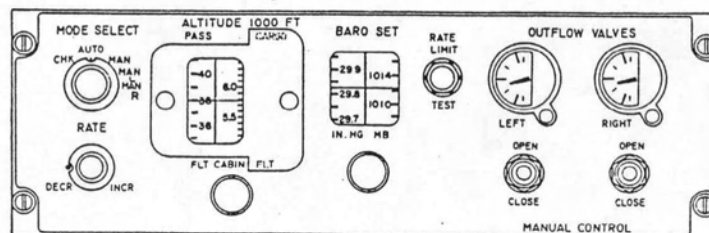

Figure 6: Representative illustration of the Flight Engineer's Cabin Pressure Control Selector Panel - (front view)

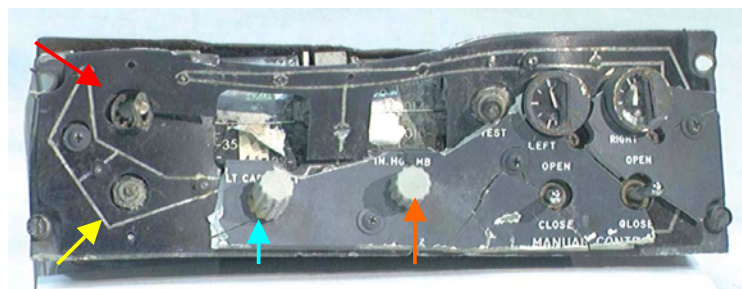

Figure 7: Flight Engineer's Cabin Pressure Control Selector Panel - (front view)

Observations:

- Deformation of chassis face.
- The light plate is deformed, delaminated and fractured. Front lamination is missing from more than 50% of the selector panel's light plate.
- **MODE SELECT** switch knob, in upper left of panel, is missing (red arrow).
- The **RATE** select knob, in lower left of panel, is missing (yellow arrow).

- The **MODE SELECT** switch knob is bent to the right and the flat index on the switch is slightly rotated clockwise from the horizontal.
- The **RATE** select switch's potentiometer shaft (on lower left – yellow arrow), is broken off.
- The **FLT CABIN** knob is still attached to the shaft and bent upward (blue arrow).
- The **ALTITUDE PASS**, altitude scale tape indications have delaminated and approximately 75% are missing.
- The **BARO SET**, scale tape indications are missing.
- The right half of the **BARO SET** scale tape indication is mostly intact and indicates a setting slightly below 1014 millibars.
- **OUTFLOW VALVES** position indicators are both showing needle positions slightly below 9 O'clock (upon initial observations prior to taking photograph, fig. # 7).
- When unit is shaken up and down the **LEFT, OUTFLOW VALVES** indicator pointer moves freely.
- The outflow valves, right **MANUAL CONTROL** switch's toggle is bent to the right.
- The outflow valves, left **MANUAL CONTROL** toggle switch can mechanically be operated to the open or closed positions and returns to the center position.
- The outflow valves, right **MANUAL CONTROL** switch can be moved to the open or closed positions but will not consistently return to the center position.
- The **BARO SET** knob appears to be aligned correctly (not bent).
- The **BARO SET** knob cannot be manually turned.



Figure 8: Flight Engineer's Cabin Pressure Control Selector Panel - (back view)

- J3 connector (right) misaligned due to deformation of rear chassis. Both connector (J3 and J4) pins are intact.
- Both connectors show contamination around multiple connector pins.

EQA 8814R

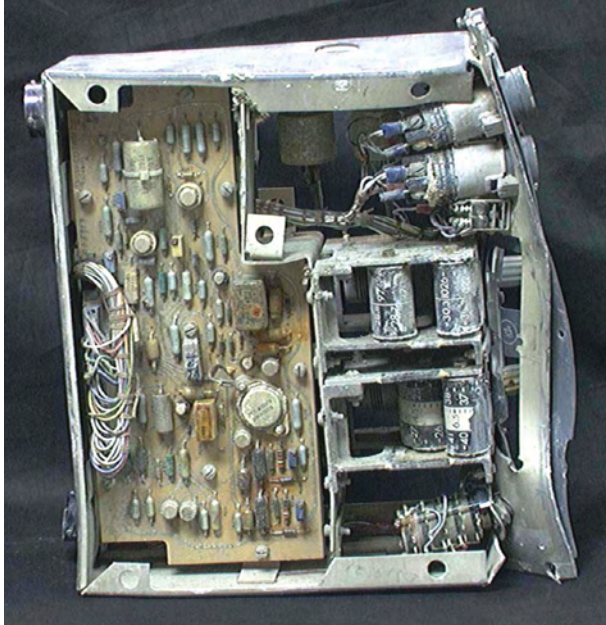

Figure 9: Flight Engineer's Cabin Pressure Control Selector Panel - (top view)

- Deformation of the face of the chassis.
- Broken spot welds and separation of face of chassis (lower right).
- Sedimentary deposits deposited throughout unit.
- Corrosion noted in multiple locations on multiple components.
- Slight deformation of rear chassis panel at the J3 plug (lower left).
- Flight **ALTITUDE** selection tape delaminated and partly missing.

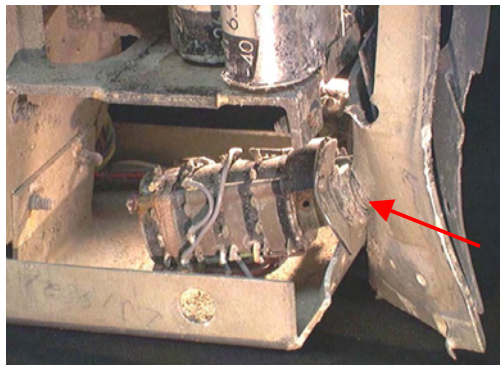

Figure 10: **MODE SELECT** Rotary Switch

- Rotary switch shaft slightly separated from front of chassis.

EQA 8814R

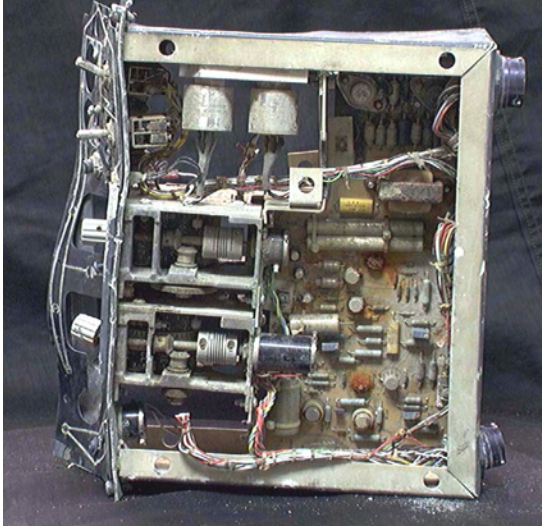

Figure 11: Flight Engineer's Cabin Pressure Control Selector Panel – (bottom view)

- Deformation of the face of the chassis.
- Sedimentary deposits deposited throughout unit.
- Corrosion noted in multiple locations on multiple components.

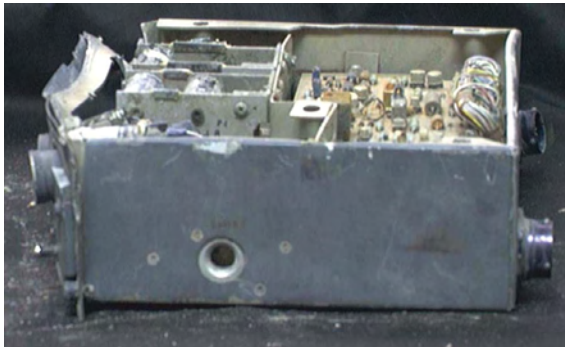

Figure 12: Flight Engineer's Cabin Pressure Control Selector Panel – (side view - cabin pressure port side).

- Deposits noted inside the sensor port.

- Nothing significant on other side of Selector Panel, (no photo).

Test results:

Electrical Continuity Tests - Performed through connector J3 pins (output of **MODE SELECT** switch).

The tests were conducted using the reference Hamilton Sundstrand overhaul manual diagram, Table 703. See the following test diagram, Figure 13.

EQA 8814R

(1) Perform a continuity test shown in Table 703:

Table 703. Continuity Test

PIN NO.	CHECK	AUTO	MANUAL	MAN L	MAN R
J3-17, J3-10	S	S	S		
J3-17, J3-11				S	
J3-17, J3-14					S
J3-15, J3-16	S	S		S	S
J3-19, J3-20	S	S			
J3-13, J3-3	S				

NOTE: "S" indicates continuity between pins; otherwise an open circuit or resistance as specified must exist.

(a) Continuity shall exist between the following points:
Pins J4-12 and J4-13; J4-11 and J3-21.

(b) Continuity shall exist between J3-15 and J3-16 during switching from Check to Auto. Discontinuity must occur between J3-15 and J3-16 in the Manual position and during switching from Manual Left to Manual Right.

Figure 13: **MODE SELECT** switch continuity table 703.

Results: Pins 17 to 10: closed
 Pins 17 to 11: open
 Pins 17 to 14: open
 Pins 15 to 16: open
 Pins 19 to 20: open
 Pins 3 to 13: open

- Continuity tests suggest setting was in manual (MAN) select mode, not AUTO.
- Confirmed wire continuity from J3 connector to rotary switch (S1)
- Initial visual inspection of the (S1) rotary **MODE SELECT** switch (reference, Figure 7) could not confirm switch setting because the shaft was bent (therefore inconclusive).
- X-ray of rotary switch (S1) could not verify **MODE SELECT** switch setting due to indistinguishable internal details.
- Disassembly of **MODE SELECT** rotary switch confirmed switch was set in manual (MAN) setting (Figure 14).

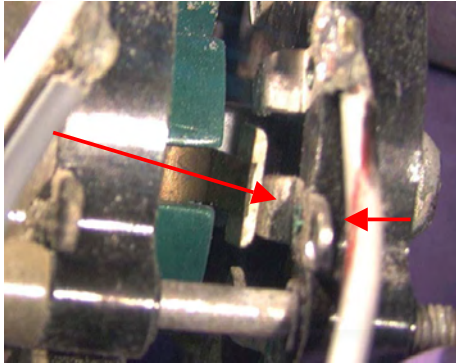

Figure 14: Panel, **MODE SELECT** Rotary Switch

- Internal contact position verification (manual).



Figure 15: **MODE SELECT** Rotary Switch, Stationary contacts, deck 3, #1-2-3 (left to right).

- Contacts of rotary switch (S1), deck 3, #1-2-3, Wear marks on contacts appear to be normal.



Figure 16: Panel, **OUTFLOW VALVES** Indicators.

Inspection of **RIGHT, OUTFLOW VALVES** Indicator (reference, Figure 16):

- Internal surface of glass face: no impact evidence from needle as viewed from exterior.
- Case removed to inspect glass from inside. No impact indication was evident on the inside surface of the glass.

Inspection of **LEFT, OUTFLOW VALVES** Indicator (reference, Figure 16):

- Internal surface of glass face: small surface anomaly observed as viewed from exterior.
- Case removed to inspect glass from inside. What appeared to be an anomaly on the inner side of glass was actually a debris deposit.
- No impact indications from needle impact were noted.

EQA 8814R



Figure 17: LEFT, OUTFLOW VALVES
Position Indicator witness mark



Figure 18: LEFT, OUTFLOW VALVES
Position Indicator showing witness mark after moving armature.

- Moving armature/needle, mounting tab corresponds to a witness mark on underlying base. This position corresponds to needle positioned at approximately 25% open. The armature was moved from its location in Figure 17 to display the “witness” pattern underneath the movable armature, shown in Figure 18.



Figure 19: RIGHT, OUTFLOW VALVES
Indicator; armature is over witness mark.

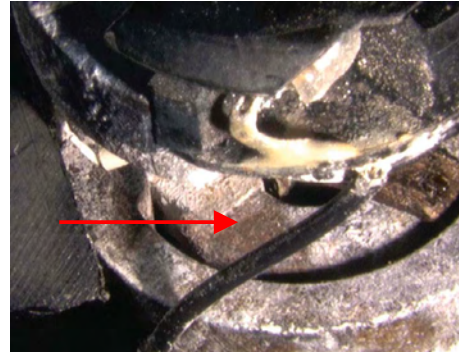

Figure 20: RIGHT, OUTFLOW VALVES
Indicator; armature moved to show witness mark.

- Armature/wiper member corresponds to witness marks on base at two places (at both extreme ends of possible needle movement). It was inconclusive as to the exact corresponding location of needle position.
- Both **LEFT** and **RIGHT, OUTFLOW VALVES** Indicators’ needles were detached from armature/needle mounting tabs and loose within the housings.

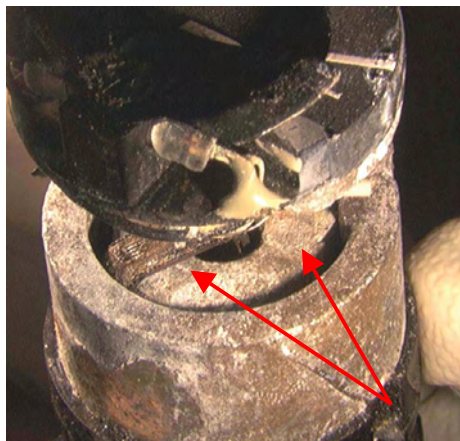

Figure 21: RIGHT, OUTFLOW VALVES

Position Indicator witness mark (right).

- There appeared to be two “witness” marks on the underlying base of this indicator. The one on the left appeared to be more distinct than the one on the right.



Figure 22: Outflow Valves, **MANUAL CONTROL, OPEN & CLOSE** toggle switches as viewed from underneath.

EQA 8814R

ITEM B.

Identification: Air Conditioning (Pack Control) Panel M170

Supplier: Boeing
 Boeing P/N: Assembly 65B46118-70
 Supplier P/N: none
 S/N: 000343
 Date Code: latest is July, 1976
 Module Number: M170

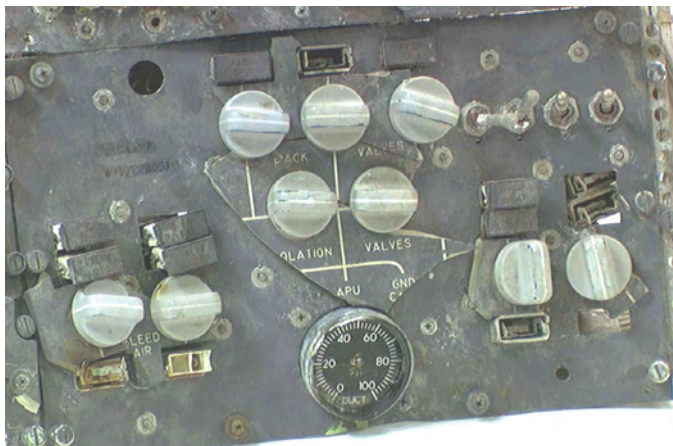

Figure 23: Detail overview of the M170 portion of the Flight Engineer's Panel.

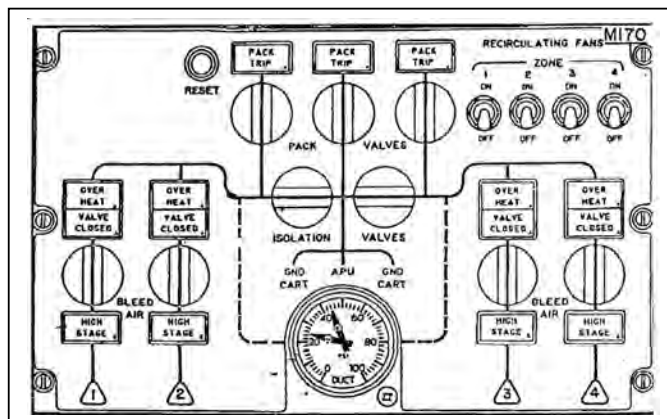

Figure 23a: Representative comparison drawing of the M170 portion of the Flight Engineer's panel.

Proposed Plan - Pack Control Panel

Part numbers – 65B46118-70

- Investigation steps (from examination of 1 photo)
 - Complete visual/microscope inspection and photo documentation.

- Verify pack valve and isolation valve switch positions by examination of flat position on switch knob, switch keyway engagement to housing, x-ray of switch interior, resistance check of switch terminals, etc. (photo shows switches in apparent “OFF” position)
- Verify pack mode and bleed air switch positions by x-ray of switch interior, resistance check of switch terminals, etc.
- Any additional testing identified during teardown and examination.

Note:

The preceding test plan steps were accomplished with the exception of the following:

- **ISOLATION VALVES** switch positions verified only by visual inspection of the knob position.
- **BLEED AIR** switches 3 & 4 were not verified by x-ray.
- Electrical resistance testing provided inconclusive results presumably because of the internal corrosion and deposits.

Note: Pack mode switches are not on this panel. The 3 **PACK VALVES** switches were tested.

General Observations:

- Panel is bent back on both sides of center area, then forward at left and right edges.
- Pack **RESET** button not attached to panel, hanging behind on wiring. Button assembly heavily corroded on all metal surfaces.
- Most of light plate is missing – portions of the light plate remain captured under **PACK VALVES** and **BLEED AIR** knobs.
- Left and right (packs 1 and 3) **PACK TRIP** lights intact on front panel. Center light (pack 2) legend plate missing.
- **PACK VALVES** knobs intact and apparently in OFF position. Shaft of left switch (pack 1) found to be broken loose from switch assembly – shaft can be pulled straight out.
- Both bleed air **ISOLATION VALVES** knobs are intact and in the OPEN position.
- Both left side **OVERHEAT** and both left side **VALVE CLOSED** bleed indication lights are intact on the front panel.
- Legend plates missing from both left side **HIGH STAGE** lights. Bulbs are missing from left (engine 1) assembly. Right bulb, and left bulb cover are intact on engine 2 assembly.
- Engine 1 and Engine 2 **BLEED AIR** knobs are in the OFF position. Engine 3 and 4, **BLEED AIR** knobs are in the ON position.
- Legend plates missing from engine 3 and 4 **HIGH STAGE** lights. Engine 4 light fixture separated from panel, but remains attached to wiring. Bulbs are missing from engine 3, fixture. Right bulb and left bulb covers (and presumably left bulb) are intact in fixture.
- Engine 3, **OVERHEAT** and **VALVE CLOSED** light fixtures are intact.
- Engine 4, **OVERHEAT** and **VALVE CLOSED** light fixtures are missing legend plates and bulbs, and displaced as if by frontal impact. They remain attached by wiring.
- **ZONE 1, RECIRCULATING FANS** toggle switch is bent to the right; switch position unknown. **ZONE 2, 3,** and **4** toggles are in the ON position.
- Several light panel bulbs are intact at various locations on panel.
- General accumulation and corrosion on all unpainted metallic surfaces.

EQA 8814R

- Duct dual pressure gage lens and needles are missing. No indication of pressure apparent.
- Identification on back of panel shows airplane RD551, assembly 65B46118-70. Investigation shows airplane RD551 (converted to 747-200B freighter) is now out of service.
- Back of panel has general accumulations and corrosion scattered throughout. Most components are at various angles relative to the back of the panel. Most wiring appears intact, with rust and corrosion on contacts.

PACK VALVES ON/OFF Switches:

Figure 24: PACK VALVES
switches, overview

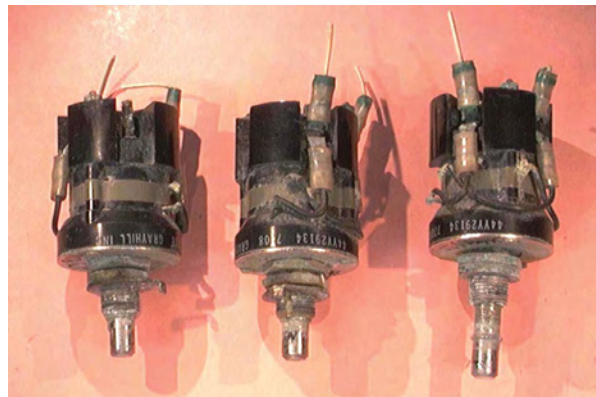

- A. **PACK VALVES** switch #1:
 Equipment number: S10
 P/N: 44YY29134
 Date code: 7708
 Manufacturer: Grayhill Inc.

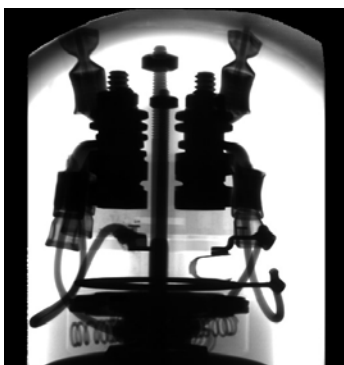

Figure 25a

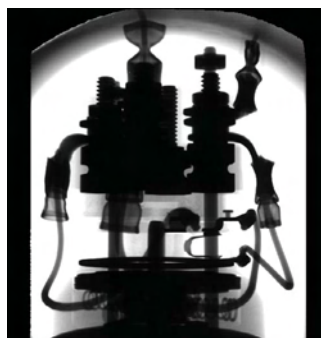
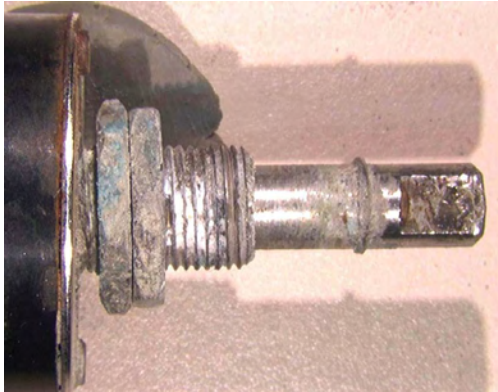

Figure 25b



Figure 25c

Figures 25a, 25b, 25c: X-rays of Pack Valve Switch #1



- Figure 26:** Detail of switch #1 shaft.
- Corrosion on all metallic parts
 - Shaft can be pulled easily from switch body.
 - Shaft is slightly bent relative to body.
 - All wiring is intact, but no continuity.
 - Terminals are significantly corroded.
 - No cracking is apparent in the switch body.
 - X-ray confirms that the valve-closed electrical contacts are aligned with each other.
 - After removal of the switch, it was noted that the indexing ring tab to shaft was sheared or corroded away.

B. PACK VALVES switch #2:
 Equipment number: S11
 P/N: 44YY29134
 Date code: 7708
 Manufacturer: Grayhill Inc.

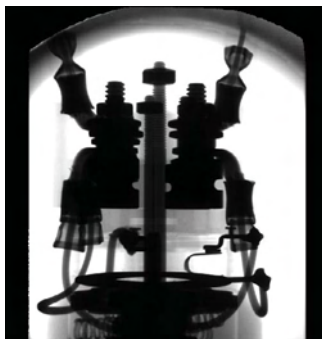

[Figure 27a](#)

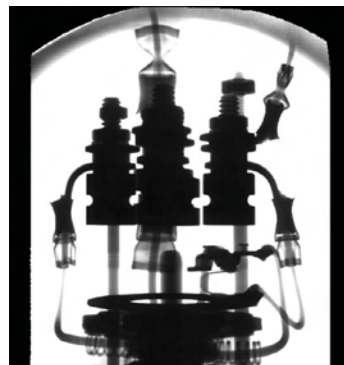

[Figure 27b](#)

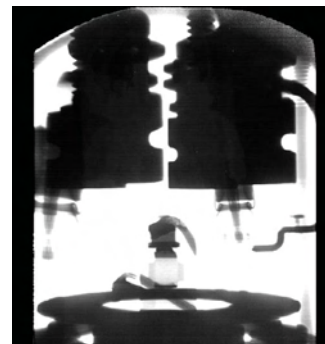

[Figure 27c](#)

[Figures 27a, 27b, 27c:](#) X-rays of Pack Valve Switch #2

EQA 8814R



Figure 28: Detail view of switch #2, cracks in the body.

- Corrosion on all metallic parts
- Minor cracking of the switch body.
- No continuity could be attained.
- All external wiring appears intact.
- X-ray confirms that the valve-closed electrical contacts are aligned with each other.

C. PACK VALVES switch #3:

Equipment number: S12
 P/N: 44YY29134
 Date code: 7708
 Manufacturer: Grayhill Inc.

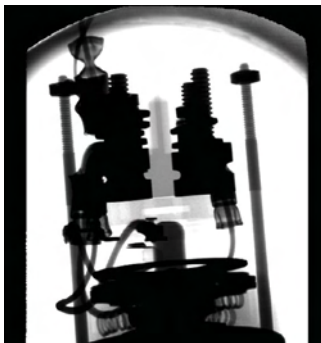

Figure 29a



Figure 29b



Figure 29c

Figures 29A, 29B, 29C: X-rays of Pack Valve Switch #3

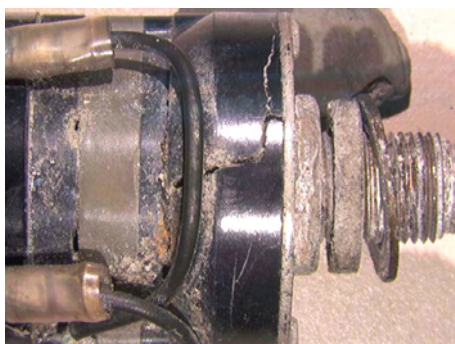

Figure 30: Switch #3 body crack detail

- Corrosion on all metallic parts
- Severe cracking of the switch body.
- No continuity could be attained.
- All external wiring appears intact.
- X-ray shows that the valve-closed electrical contacts are not aligned with each other. Misalignment approximately 10 degrees. The switch knob was not in the full closed position.

BLEED AIR Switches:

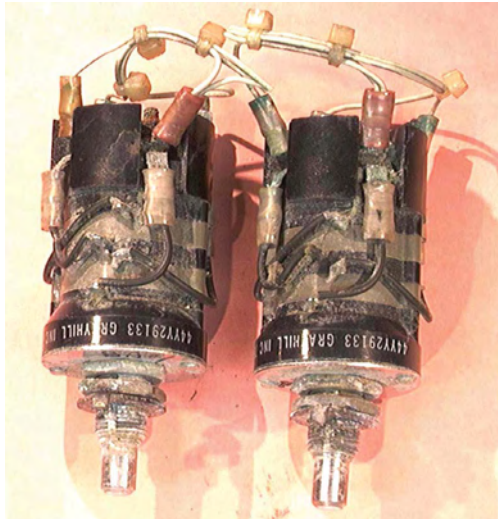

Figure 31: BLEED AIR switches #1 & #2 overview

- A. **BLEED AIR** switch #1:
Equipment number:
P/N: 44YY29133
Date code: 7543
Manufacturer: Grayhill Inc.

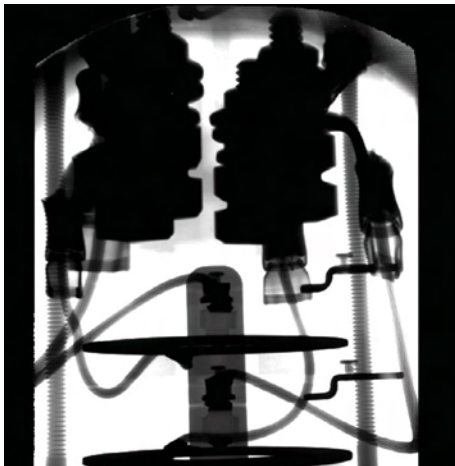

Figure 32: X-ray of Bleed Air Valve Switch #1.

- X-ray confirms that both sets of active electrical contacts are aligned with each other.

EQA 8814R



Figure 33: Bleed Air Switch #1

- Displaced nut
- Knob in OFF position
- Rear mounting nut has been displaced.
- Corrosion on all metallic parts



Figure 34: Bleed Air Switch #1.

- Minor cracking of housing is apparent.
- Crack detail.
- No continuity could be attained.
- All external wiring appears intact.

B. BLEED AIR switch #2:

Equipment number:
 P/N: 44YY29133
 Date code: 7543
 Manufacturer: Grayhill Inc.

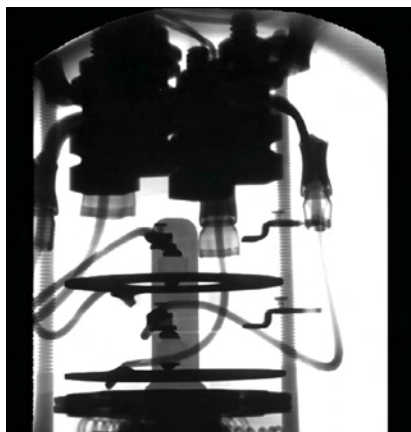

Figure 35: X-ray of Bleed Air Valve Switch #2.

- X-ray confirms that both sets of active electrical contacts are aligned with each other.

EQA 8814R



Figure 36: **BLEED AIR** switch 2.

- Minor cracking of housing apparent.
- Detail of cracks.
- No continuity could be attained.
- All external wiring appears intact.
- Knob in OFF position
- Corrosion on all metallic parts

C & D. **BLEED AIR** switches #3 and #4:

- Knobs in ON position.
- These switches were not removed from the control panel.
- General external condition of switches was similar to switches #1 and #2.

EQA 8814R

ITEM C.

Identification: **Cabin Altitude Pressure Module (M188)**

Supplier: Boeing
 Boeing P/N: 69B46107-11
 Supplier P/N: N/A
 S/N: 000322
 Date Code: none
 Module Number: M188

Initial observations:



Figure 37: M188 panel. Note that the vertical speed indicator was detached from the module.

- Vertical Speed Indicator not attached to panel (blue arrow).
- Corrosion present on various surfaces with salt residue and sediment.
- **AUTO FAIL** legend plate is missing (purple arrow).
- **PRESS RELIEF** lower Indicator light cover is missing (red arrow).
- Panel frame is bent inward on left and broken at Vertical Speed Indicator frame.

Detailed observations of various sub-components:

Identification: **Pressure Relief Light, (upper)**

Supplier: Clare (97564)
 Boeing P/N: BAC00149-47
 Supplier P/N: 670822-B6-47
 S/N: N/A
 Date Code: 7821

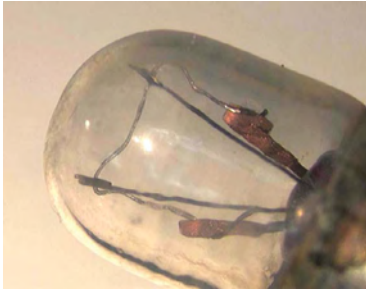

Figure 38: PRESS RELIEF light, upper, left lamp, (filament intact) - (Ref. Figure 37, yellow arrow for lamp location).

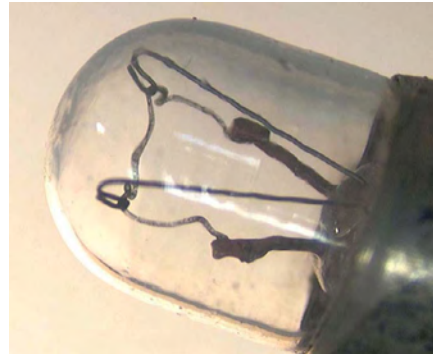

Figure 39: PRESS RELIEF light, upper right lamp, (filament intact). - (Ref. Figure 37, yellow arrow for lamp location).

Identification: **Pressure Relief Light (lower)**

Supplier:	Clare (97564)
Boeing P/N:	BAC00149-47
Supplier P/N:	670822-B6-47
S/N:	N/A
Date Code:	7821



Figure 40: PRESS RELIEF light, lower left lamp.
 • Filament is broken - (Ref. Figure 37, red arrow for lamp location).



Figure 41: PRESS RELIEF light, lower right lamp.
 • Filament appears to be intact.
 • Legend plate missing. (Ref. Figure 37, red arrow for lamp location).

EQA 8814R

Identification: Cabin Altimeter Indicator

Supplier: Jaeger
 Boeing P/N: N/A
 Supplier P/N: 64141862-1
 S/N: 361
 Date Code: 11-79
 F/T Date: 21 Nov 1979

Initial observations:



Figure 42: CABIN ALT Indicator (Ref. Figure 39, green arrow for location on module)

- 50% of face obscured by opaque discoloration inside of glass.
- BARO set knob bent upward.
- Dent in rear, top side of case.
- Dent on bottom side of case.
- Corrosion on sense line connection.
- Barrel Indicator reads approximately 13,000.
- Needle and barometric setting obscured by discoloration.
- Electrical connector appears undamaged.

Detailed observations:

- X-ray examination of internal parts revealed distorted bellows. No other observations made due to indistinguishable details.



Figure 43: Cabin Altimeter Indicator, glass bezel removed

- Heavy coating of unknown sedimentary type debris on face of indicator (unknown black glutinous contaminant).
- After cleaning off debris, altimeter indicator reading confirmed to be 13,765 +/- 5.
- Microscopic examination of inner side of bezel shows no sign of impact damage.

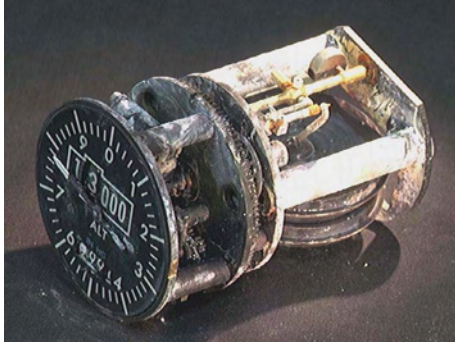

Figure 44: Cabin Altitude Indicator, housing removed.

- Removed back of Altitude Indicator housing to observe internal mechanism. Large amount of sedimentary type debris noted internally.
- No observable damage to internal mechanical parts. It did not appear that the physical damage to the outer case caused the case to come into contact with inner components.
- Significant amount of sedimentary type debris noted on internal parts.

Figure 45: Cabin Altitude Indicator, sector gears

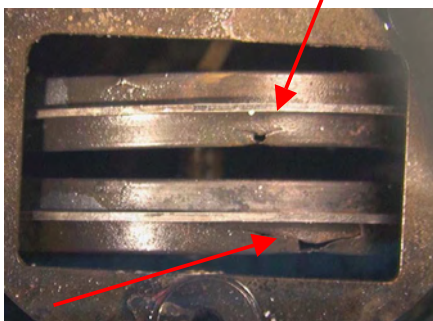

Figure 46: Cabin Altitude Indicator, bellows, visible damage

- Both bellows have fractures along the outer circumference of the bellows. Those fractures appear on a portion of the bellows at the back of the instrument. The fractures are on the lower half of each of the bellows. The edge features, at the fractures, are oriented outward from the inside of the bellows.

Figure 47: Cabin Altitude Indicator, bellows displacement

- The upper bellows is tilted with respect to its axis. The lower bellows is also tilted, but to a lesser degree.
- The upper bellows is in contact with the gear mounting plate. The lower bellows flange is deformed at the point nearest the gear mounting plate, but doesn't contact the plate.



EQA 8814R

Identification: **Cabin Vertical Speed Indicator**

Supplier: Smiths Industries
 Boeing P/N: 60B00103-1
 Supplier P/N: WL 301 RC/JA/1
 S/N: AF/594/069
 Date Code: N/A

Initial observations:



Figure 48: Cabin Vertical Speed Indicator

- Glass is broken.
- Numerous dents are on case.
- Needle is frozen at 500 FPM climb.

Detailed observations:

Figure 49: Cabin Vertical Speed Indicator (close-up overview)

- Safety wires at the rear of the case, 2 (each) were intact.
- Badly damaged housing; required milling for removal.
- Internal inspection revealed damage to internal components as a result of external impact to housing.
- No needle impact marks found on glass face and indicator face.
- Examination of the inside of the indicator glass face noted water marks (sediment deposit) that correspond to observed needle position (no needle impact marks).



Identification: Cabin Differential Pressure Indicator

Supplier: Jaeger
Boeing P/N: 60B00105-11
Supplier P/N: 64070-760-1
S/N: 227
Date Code: 11/79
F/T Date: 22 NOV 1979

Initial observations:



Figure 50: Cabin **DIFF PRESS** Indicator

- Water stains inside glass face.
- Needle is indicating below zero.

Detailed observations:

- Removal of the bezel did not reveal any abnormal markings on inside of glass.
- Dial indicated less than zero (at approximately 0.6 - 0.8 psi).
- Casing was removed. Cabin pressure line was cut to remove indicator from case. When pressure line was cut, the indicator dial returned to zero.
- No apparent damage was visible to internal parts.
- Minimal corrosion was present on internal surfaces.
- Red scale mark on face at approximately 9.25 – 9.3 (mechanism is physically limited at that point).

EQA 8814R

ITEM D.

Identification: **Flight Engineers Panel (Modules M179, M183, M184, M557)**

Supplier: Boeing
Boeing P/N: 65B46006-5061 (ref.)

Initial observations:

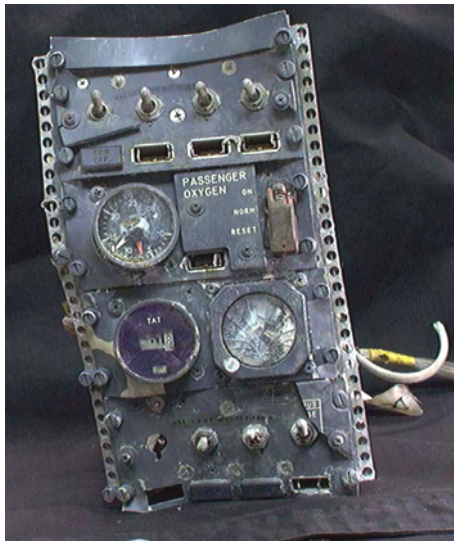

Figure 51: Flight Engineers Panel, overview. Includes modules M179, M183, M184 & M557.

M179 Galley Power



Figure 52: Galley Power control panel M179

- Light plate is missing.
- All switch toggles are in up position.
- **TRIP OFF** indicator lights, numbers 2, 3 & 4 legend plates, bulbs and retaining assemblies are missing.

M183 Passenger Oxygen



Figure 53: Passenger Oxygen Panel, module M183.

Identification:	OXY Pressure Indicator
Supplier:	Weston
Boeing P/N:	60B00120-1
Supplier P/N:	260461
S/N:	09770463
Date Code:	Sep. 23, 1977

Detailed observations:

- Case removed indicator- found heavy corrosion and sedimentary deposits present internally.
- **PASSENGER OXYGEN** needle was disconnected from its driving rod, either on disassembly or prior to disassembly.
- No indication of needle strike on indicator face.
- Dial indicator needles at 700 PSI for passenger and 1250 PSI for crew.
- Residue visible through glass face of indicator.
- Power **ON** indicator legend plate, bulbs and retaining assembly are missing.
- Switch guard safety wire is broken.
- Switch guard broken and partially missing.
- Light plate is intact.

Test results:

PASSENGER OXYGEN control switch of Module M183 was found to be in the **NORM** position as received. Continuity tests indicated that the switch functioned properly in the **ON**, **NORM** and **RESET** positions. See Figures 54 through 58.

EQA 8814R

Detailed observations:



Figure 54: X-ray of switch

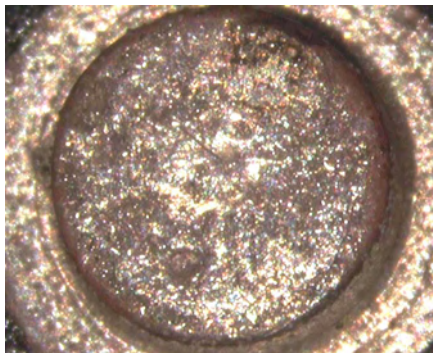

Figure 55: Stationary contact of oxygen control switch "ON" position.

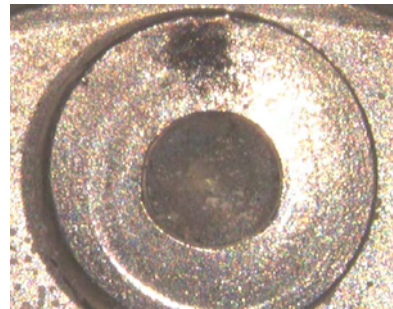

Figure 56: Movable contact of oxygen control switch "ON" position.

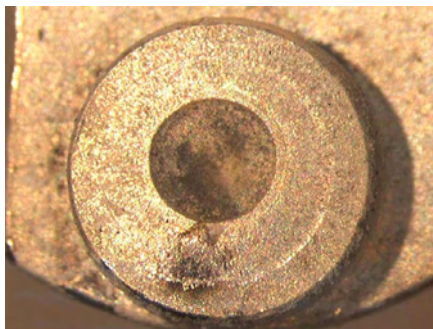

Figure 57: Movable contact of the oxygen control switch "RESET" position.



Figure 58: Stationary contact of oxygen control switch ("RESET" position).



Figure 59: Switch guard overview, right side.



Figure 60: Switch guard overview, left side.



Figure 61: Top view of switch guard damage.



Figure 62: Bottom view of switch guard damage.



Figure 63: Switch guard safety wire (breakaway wire) hole (top view).

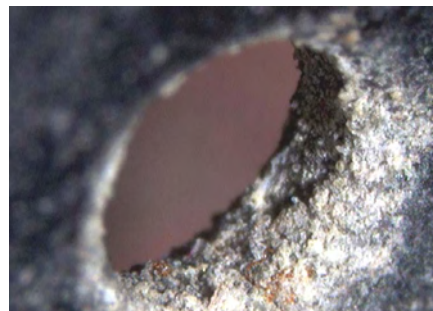

Figure 64: Switch safety wire (breakaway wire) tab hole.

- Observed sediment contamination on inside diameter of hole, recess.

EQA 8814R

M184 Clock Panel



- Figure 65:** Clock Panel, module M184
- Clock glass is fractured.
 - Hands set at approximately 0825, partially obscured by broken glass.
 - **TAT** partially obscured by discoloration.
 - Reads 1.8 deg. C and **OFF**
 - After removal from Flight Engineer's Panel, slight impact damage to top rear of case was noted.

Identification:	Clock Module
Supplier:	Airpax
Boeing P/N:	60B00100-23
Supplier P/N:	A15522-P3
S/N:	236
Date Code:	8/80

Detailed observations:

Figure 66: M184 Clock, face glass fractured heavily.

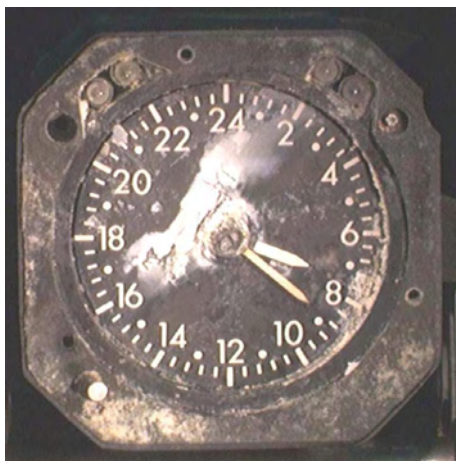
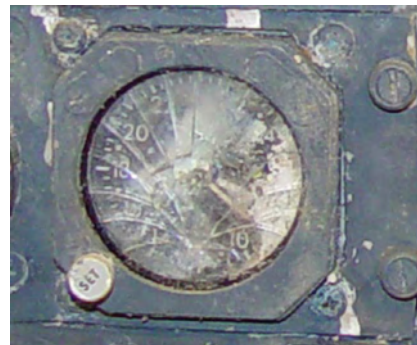

Figure 66a: M184 Clock, face glass removed.

- After removal of bezel, actual time on clock reads 0722

M557 DC BUS ISOLATION



Figure 67: DC BUS ISOLATION panel, module M557

- Light plate is missing.
- All three switches' toggles are in up (**CLOSE**) position.
BUS 3 and **BUS ESS** toggles are bent upward.
- **ESS BUS**, & **OPEN** indicators legend plates, bulbs and retaining assemblies are missing.

EQA 8814R

ITEM E.**Identification: Pressure Relief Valves**

Supplier: Hamilton-Sundstrand
Boeing P/N: 60B00025-19

Proposed Investigation Plan

It is proposed that the following recovered items be examined as noted below by the investigating team at the Boeing Equipment Quality Analysis (EQA) Lab in Seattle. This examination is part of the continuing investigation of the China Airlines Flight 611 accident. The examination and testing is expected to take approximately 2 to 3 days after receipt of items at the lab. Boeing's EQA Lab in Seattle is available to perform the examination during the second or third week of October dependent upon ASC scheduling. The component supplier, Hamilton Sundstrand, is prepared to participate in the examination activity. All steps will be photo documented and a test report will be prepared by Boeing for the ASC. The steps proposed below are based on limited information and photographs of the parts in question. The investigating team may elect to deviate from these plans during the examination if warranted by the actual condition of the parts.

Proposed Plan: Pressure Relief Valves (2 units)

- Investigation steps (from examination of 9 photos)
 - Complete external visual inspection of both valves and photo document.
 - Inspection emphasis on:
 - Relief seal area
 - Diaphragms
 - Sensing housing areas
 - Ambient sense lines
 - All external orifices (including orifice under filter)
 - Position of sensor adjustment screws
 - Any contact witness marks between moving parts.
 - Pay attention to any salt/corrosion buildup on any moving parts that may note position prior to any attempt to move any part(s) and photo-document.
 - Determine if water remains within valve and identify method to purge
 - X-ray inspection of poppet area. Compare to known good unit if possible.
 - Leak check of ambient sense lines
 - Possible cracking pressure test of valve that appears intact in photos
 - Possible functional test of sensor units
 - Internal tear-down inspection
 - Inspection emphasis on:
 - Sensor poppet area
 - Internal diaphragm
 - Examination of the external flap hinge pins or remaining hinge mechanism for any evidence of position prior to departure
 - Any additional testing identified during teardown and examination.

Note:

The aforementioned investigation steps were accomplished with the exception of the following:

- Orifice under filter was not reviewed, because filter to lower section of valve was not removed.
- Water was noted dripping from both units, during disassembly, and was also evident in x-ray. No attempt was made to purge water.
- No leak check of sense lines was performed. Lines did not appear to be clogged.
- Damage to valves did not allow for cracking pressure test of valves.
- Attempted functional test of sensors while installed during x-ray. No movement of poppets was noted. During disassembly, contamination was noted as likely cause.
- Teardown inspection of internal diaphragm was not performed, per decision of investigation team (not deemed necessary at this time).

Photographs of items “as received”:



Figure 68: Overview of the pressure relief valves, wrapped as received.



Figure 69: Overview, baseline photo. Next 3 photos are of the part being rotated clockwise (CW) 90°, in succession, after taking each photo.

EQA 8814R



Figure 70: Overview (rotated 90° CW (clockwise) from baseline figure #69).



Figure 71: Overview (rotated 180° CW from baseline figure #69).



Figure 72: Overview (rotated 270° CW from baseline figure #69).



Figure 73: Overview, baseline photo (valves were flipped over 180°. Next 3 photos are views of the valves rotated clockwise (CW) 90°, in succession, after taking each photo).



Figure 74: Overview (rotated 90° CW from baseline figure #73).



Figure 75: Overview (rotated 180° CW from baseline figure #73).



Figure 76: Overview (rotated 270° CW from baseline figure #73).



Figure 77: Upper pressure relief valve, (center of picture) distorted exterior skin.



Figure 78: Upper & Lower Pressure Relief Valves, orientated as installed on airplane, [vertical centerline (C/L) through both valves at station 770].



Figure 79: Upper & Lower Pressure Relief Valves, as installed, as viewed from inside.

Figure 80: Frame, centerline (C/L) of stringer 31, looking fwd (frame view station 780).



EQA 8814R



Figure 81: Upper Pressure Relief Valve, showing orientation, note that blowout doors are missing.



Figure 82: Upper Pressure Relief Valve, close-up showing markings.



Figure 83: Upper Pressure Relief Valve, orientation as installed on airplane.



Figure 84: Upper Pressure Relief Valve still installed, as viewed from the inside.

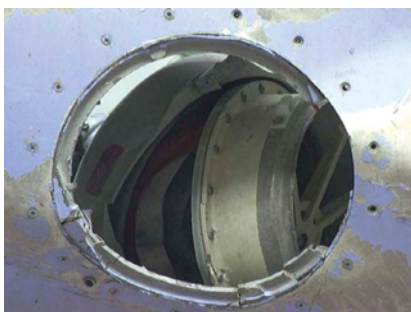

Figure 85: Lower Pressure Relief Valve, orientation as installed on airplane.

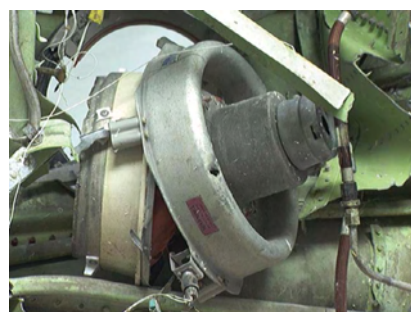

Figure 86: Lower Pressure Relief Valve, still installed, as viewed from the inside.

Part name: Upper Pressure Relief Valve

Identification:

Supplier: Hamilton Sundstrand
 Boeing P/N: 60B00025-19
 Supplier P/N: 715995-3,
 S/N: 901223
 Date Code: FT 09/98, Mod # L-18, -HS Ref AN, cage code 73030



Figure 87: Upper Pressure Relief Valve, data plate and FT date.

Initial observations:

* All noted references to location are based upon the valves in the “as installed” airplane orientation from the pilot’s perspective.

- (1) Removed valve by:
 - (1) Cutting two lead wires of switch.
 - (2) Removed 2 screws (P/N NAS603-6P plus washers NAS620-10L) that detached the gate guide HS P/N 733833-1 from valve housing HS P/N 727406-1 (removed 2 out of 4 gate guides [2 already detached])



Figure 88: Prior to cutting switch lead wires.



Figure 89: After cutting wires.

EQA 8814R



Figure 90: Exterior view of opening with valve not yet removed.

- Hinge pins are movable (free to rotate); aft/upper hinge pin is only one difficult to rotate and is bent outboard.

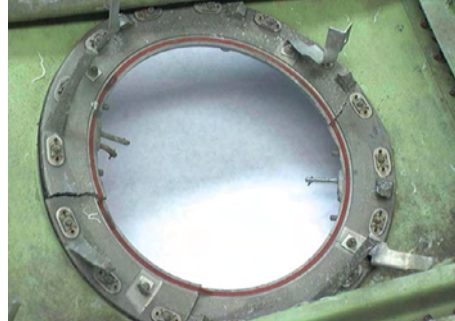

Figure 91: Interior view of opening with valve removed (looking inside to outside).

- Forward/lower hinge pin missing.



Figure 92: Upper Pressure Relief Valve, pins in approximately "door closed" position.



Figure 93: Upper Pressure Relief Valve, pins are in approximately "door closed" position.



Figure 94: Upper Pressure Relief Valve, pins in approximately "door fully open" position.



Figure 95: Upper Pressure Relief Valve, same as # 94, another view.

- Performed **measurement** of pin angles using a flat reference plane (outer skin of aircraft); using two imaginary reference lines running between the centerlines of the pin mounting holes (upper fwd to upper aft) & (lower fwd to lower aft). All angular measurements were based from these two imaginary lines. (See: diagram. Upper Valve, flapper doors' pins, orientation, Figure 96).
- Results of measurements (approximation):
Upper aft pin = 13°; Upper fwd pin = 161°; Lower aft pin = 53°

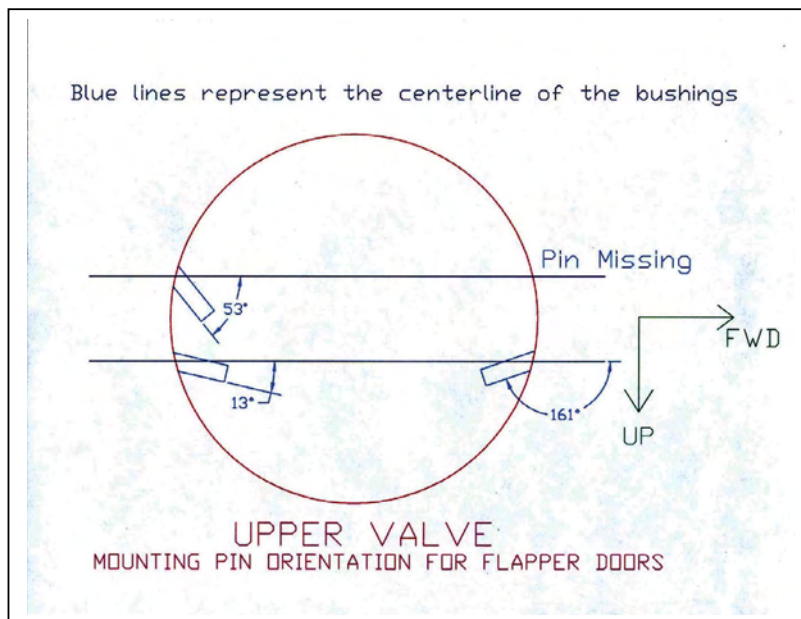

Figure 96: Upper Pressure Relief Valve, flapper valve doors, pin orientation.

- The hinge pins on both doors were protected from further movement, for storage purposes.



Figure 97: Non-metallic washer (gate seal) - continuous ring.

- Slight impression of knife-edge on seal.



Figure 98: One slight cut adjacent to housing fracture.

EQA 8814R



Figure 99: Another cut on the seal.



Figure 100: Discolored region of gate seal.
 • Unknown white colored contaminant on seal.

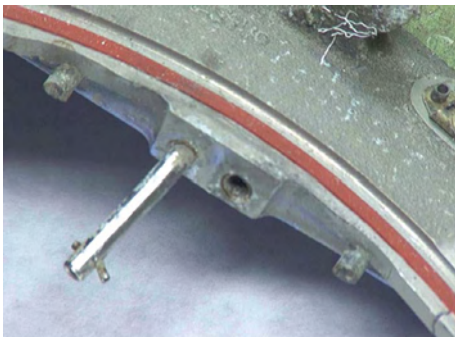

Figure 101: Forward stops & hinge pin, (looking from inside to outside).
 • Forward/lower hinge pin is missing.



Figure 102: Forward stops and hinge pins, (looking from outside to inside).
 • Forward/upper hinge pin can rotate freely.
 • Stop pins look normal and unbent.



Figure 103: Forward/upper hinge pin, physically rotated by hand so that bent portion was oriented outboard.

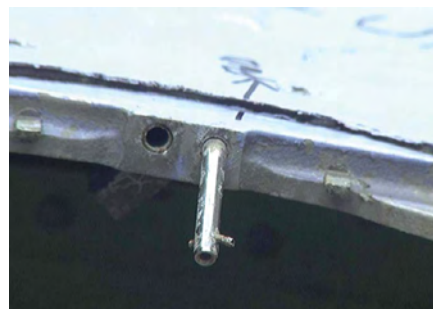

Figure 104: Forward/upper hinge pin, physically rotated by hand to bend inboard.



Figure 105: Detail of forward/upper hinge pin end.



Figure 106: Aft hinge & stop pins (looking from inside to outside).

- Aft/lower stop pin appears to have a rust mark and can rotate.



Figure 107: Aft hinge & stop pins, (looking from outside to inside)

- Aft/upper hinge pin (lower pin in photo) is difficult to rotate.
- Aft/lower hinge pin (upper pin in photo) rotates.



Figure 108: Close-up of aft stop & hinge pins (looking from inside out).



Figure 109: Close-up of aft hinge pins (looking from outside to inside).

EQA 8814R



Figure 110: Aft hinge pins, upper & lower. Aft/lower pin is rotated to non-closed door position.



Figure 111: Aft hinge pins, upper & lower. Both pins rotated to "closed door" position.

Figure 112: Aft/upper hinge pin, cotter pin is broken.

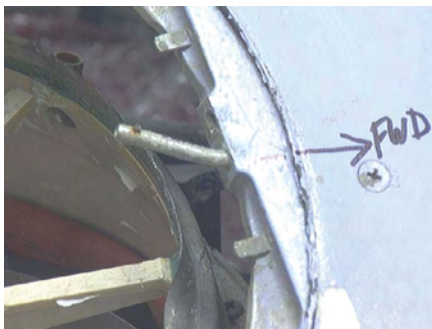
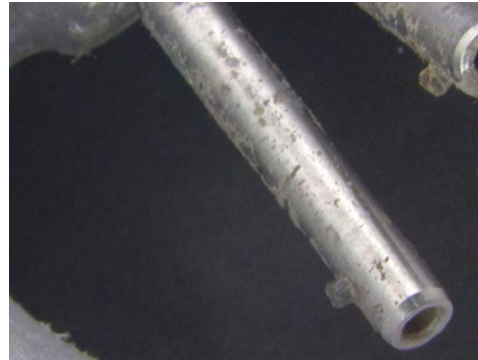
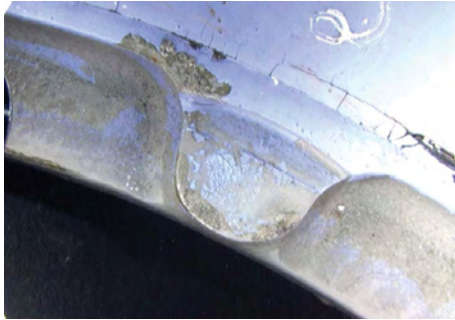

Figure 113: Forward/upper hinge pin, upper door (forward/ lower hinge pin is missing).



Figure 114: Detail of forward/lower hinge pin bushing in hole.



[Figure 115](#): Upper stop, pad.



[Figure 116](#): Upper stop, pad, close-up of figure #115.

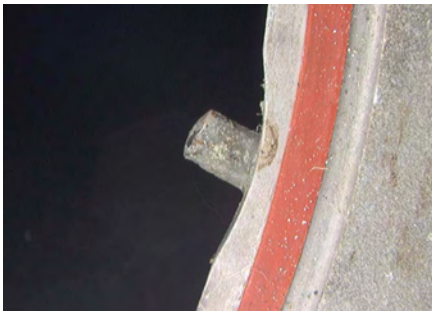

[Figure 117](#): Overview of forward/upper stop pin as viewed from inside.

- Pin is relatively straight.



[Figure 118](#): Forward/upper stop pin; close up of figure #117.



[Figure 119](#): Overview of forward/upper stop pin, as viewed from outside.

- Pin is relatively straight, paint missing.

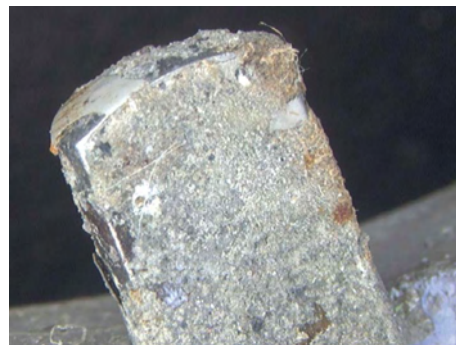

[Figure 120](#): Forward/upper stop pin, close-up of figure #119.

EQA 8814R

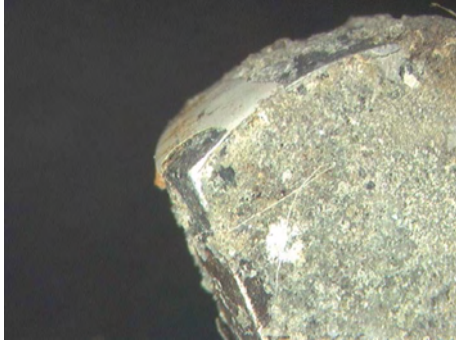

[Figure 121](#): Forward/upper stop pin, close-up of figures #119 & #120.



[Figure 122](#): Overview of aft/upper stop pin, as viewed from inside.

- Pin is relatively straight.

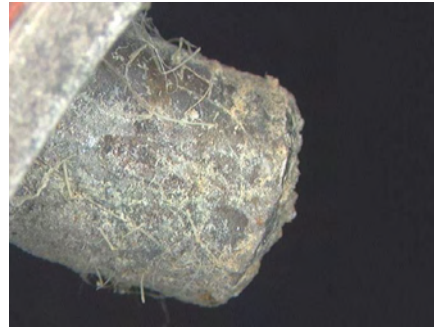

[Figure 123](#): Aft/upper stop pin; close up of figure #122.



[Figure 124](#): Aft/upper stop pin, close up of figures #122 & #123, after pin was cleaned with alcohol.



Figure 125: Overview of aft/upper stop pin as viewed from outside.

- Pin is relatively straight.

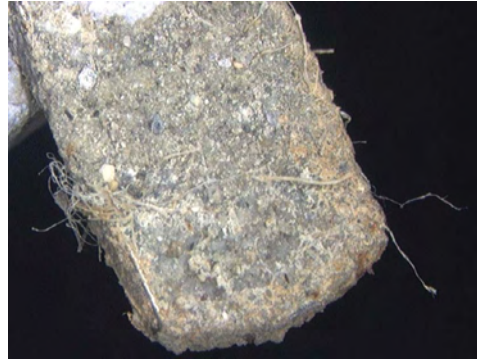

Figure 126: Aft/upper stop pin, close-up of figure #125.

- Paint is chipped.



Figure 127: Lower stop pad.

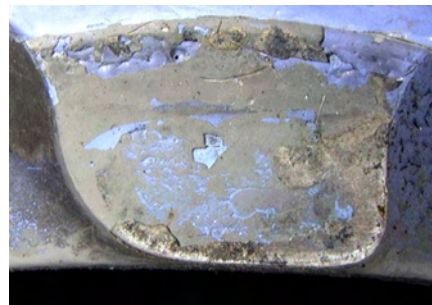

Figure 128: Lower stop pad, close-up of figure #127.

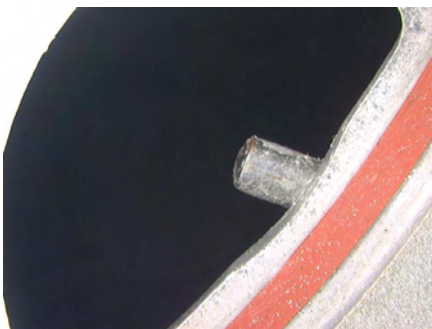

Figure 129: Overview of forward/lower stop pin, as viewed from inside.

- Pin is relatively straight.



Figure 130: Forward/lower stop pin, close up of figure #129.

EQA 8814R



Figure 131: Overview of forward/lower stop pin, as viewed from outside.

- Pin is relatively straight.

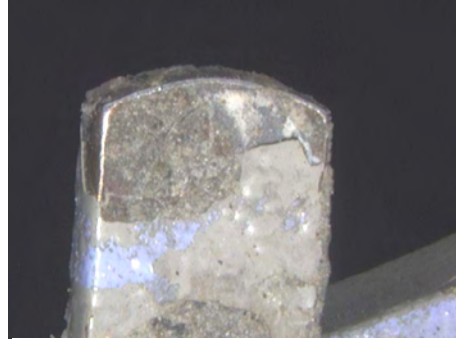

Figure 132: Forward/lower stop pin, close-up of figure #131.



Figure 133: Overview of aft/lower stop pin, as viewed from inside.

- Pin is relatively straight.



Figure 134: Aft/lower stop pin; close up of figure #133.

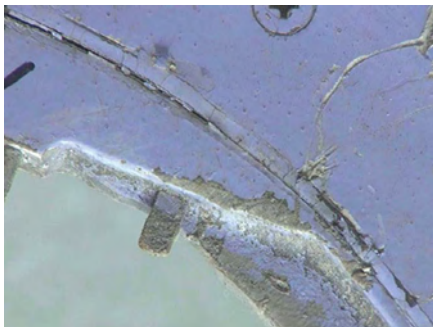

Figure 135: Overview of aft/lower stop pin, exterior view.



Figure 136: Aft/lower stop pin.
 • Overall, pin is relatively straight.



Figure 137: Aft/lower stop pin, close-up of figure #136.
 • Paint is chipped.

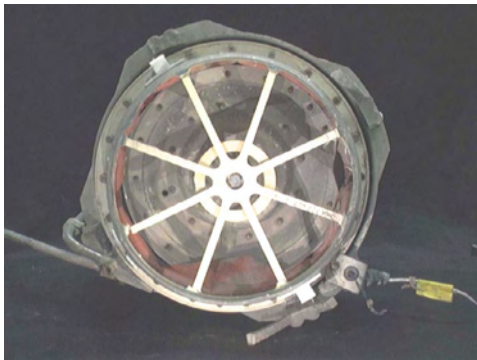

Figure 138: Overview of valve face.
 • Knife-edge has some rolled over areas and some bent edges.
 • In general, reasonably round.
 • 2 gate spacers, HS P/N 727407-30 are missing, remaining 2 spacers on top and bottom as shown.



Figure 139: Close-up of knife-edge damage.



Figure 140: Close-up of knife-edge damage.



Figure 141: Close-up of knife-edge damage.

EQA 8814R



Figure 142: Overview, close-up of typical web fracture.



Figure 143: Close-up of web, representative of web fractures at gate ID.



Figure 144: Worst of the center web cracks. 2 of 8 appear to be intact, remaining exhibit various degrees of cracking.



Figure 145: Diaphragm, 75 % of outer circumference is torn/split.

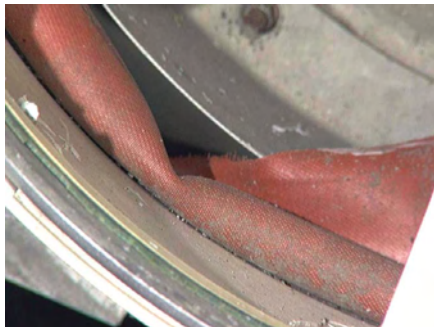

Figure 146: Diaphragm, showing typical tear.



Figure 147: Diaphragm, apparently intact portion.



Figure 148: Diaphragm, circumferential tear.



Figure 149: Offset angle between valve housing and gate.

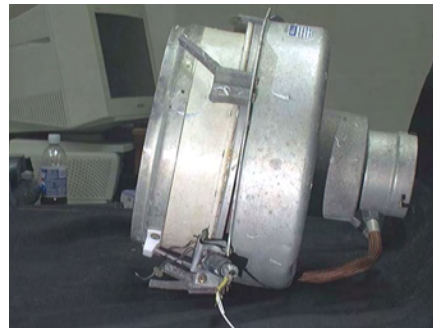

Figure 150: Offset angle (same as in figure #149) from the opposite side.

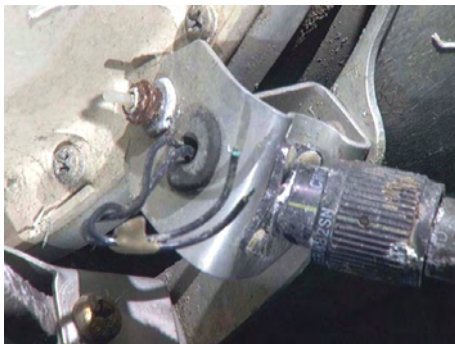

Figure 151: Switch mounting bracket, gate is against bracket.

- The switch actuator is intact but the basic switch is missing.
- The (electrical connector and plug) mating is intact.



Figure 152: Upper Pressure Relief Valve; valve gate & switch bracket.

EQA 8814R



Figure 153: Center diaphragm & return spring.

- Diaphragm is intact and spring is unseated from valve cover.



Figure 154: Center diaphragm guide, HS P/N 727411-1, showing distortion of guide itself.

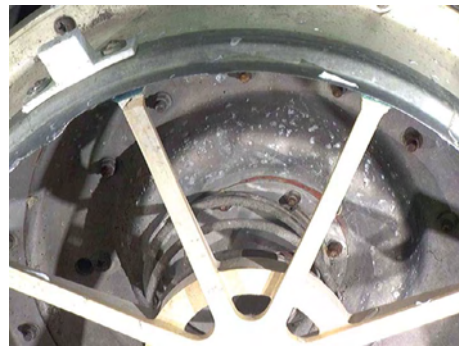

Figure 155: Gate return spring, showing unseated spring.



Figure 156: Overview of control and filter assemblies.

- The filter (HS P/N 715942-1), cover (HS P/N 727423-1) and spring (HS P/N 727430-1) – are all missing.
- Control orifice shown in bottom of filter housing looks clean.
- Exterior of sensors exhibit light deposits of contamination.



Figure 157: Exterior view of sensors, showing some apparent corrosion on the integral ambient sense tube.



Figure 158: Cabin pressure sense ports on sensor adjustment springs.

- Holes look clear.
- Corrosion on tube retainer plate (HS P/N 727417-2).



Figure 159: Control adjustment screws.

- Tamper proof seals are in place.

EQA 8814R

X-rays of Upper Pressure Relief Valve:

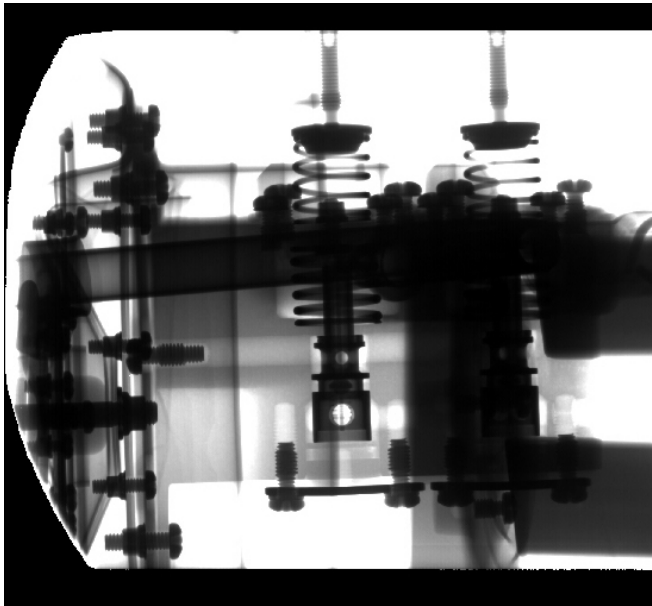

Figure 160: Upper Pressure Relief Valve, control assembly, x-ray.



Figure 161: Integral control adjustment spring.

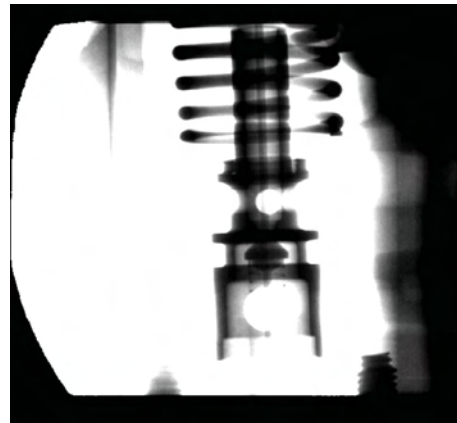

Figure 162: Integral control poppet.

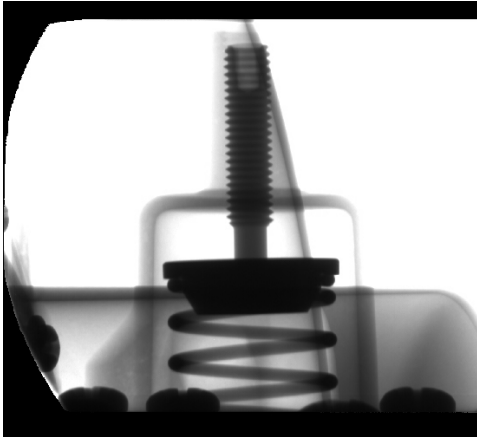

Figure 163: Remote control adjustment spring.

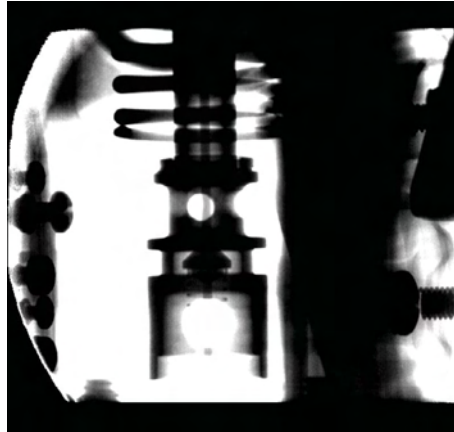

Figure 164: Remote control poppet.

Disassembly observations:

(1) Removed the remote ambient sensor poppet.



Figure 165: Remote ambient sensor housing bore.

- Salt & moisture present.
- Poppet is frozen.



Figure 166: Diaphragm appears to be intact.

- Salt deposits on spring.
- Heavy corrosion on spring seat (one-third).

EQA 8814R



Figure 167: Remote ambient sensor poppet and guide, opposite side - relatively clean.

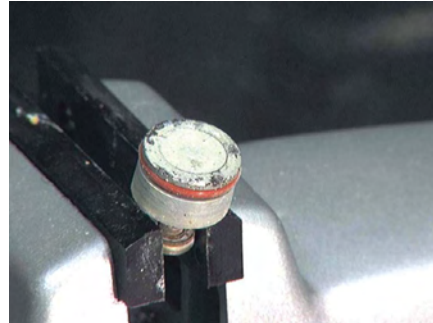

Figure 168: Plug, remote ambient poppet.



Figure 169: Shows water in plug area.



Figure 170: Integral ambient sensor poppet housing bore.

- Poppet was free.



Figure 171: Integral ambient sensor spring & diaphragm.

- Heavy hardened corrosion on spring and diaphragm in localized areas.
- Corrosion on spring seat almost all the way around.



Figure 172: Opposite end of integral ambient sensor poppet and guide.

- A little moisture is present.

EQA 8814R

Figure 173: Plug detail.



EQA 8814R

Part name: Lower Pressure Relief Valve

Identification:

Supplier: Hamilton Sundstand
 Boeing P/N: 60B0025-19
 Supplier P/N: 715995-3
 S/N: GG2739
 Date Code: FT 10/98 (as viewed under microscope); HS Ref P10



Figure 174: Lower Pressure Relief Valve data plate, identified FT 10/98 with microscope.



Figure 175: Lower Pressure Relief Valve, data plate identification.

Initial observations:



Figure 176: Lower Pressure Relief Valve as viewed from outside, still installed but not attached to structure. (Ref. For following section on pins and stops)

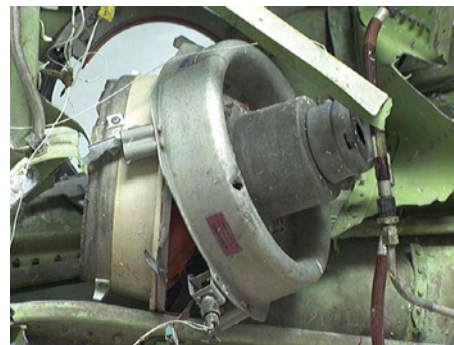

Figure 177: Lower Pressure Relief Valve as viewed from inside, still installed but not attached to structure. (Ref. For following section on pins and stops)



Figure 178: External view of opening for Lower Pressure Relief Valve, looking inside.



Figure 179: Exterior opening for Lower Pressure Relief Valve (valve still inside).

- External view shows the heads of 5 attachments screws to the skin, are missing and about 25% of mounting flange is missing.

- Removed unit from panel by: – (1) Cutting 2 lead wires of switch.
(2) Cutting the integral ambient sensing tube.

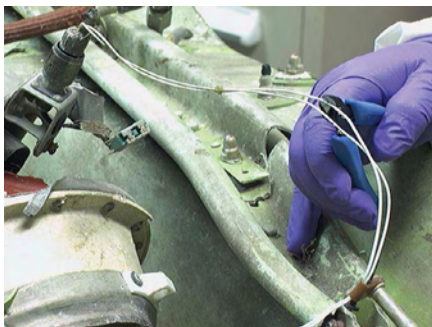

Figure 180: Lower Pressure Relief Valve. Cut switch lead wire A, step 1 in removal of lower valve (before cut).



Figure 181: Lower Pressure Relief Valve. Cut switch lead wire B, step 2 in removal of lower valve (after cut).



Figure 182: Lower Pressure Relief Valve. The integral ambient sensing tube, step 3, had to be cut in order to remove the lower valve.

- Performed boroscope examination of Lower Pressure Relief Valve at:
 - (1) Integral ambient port interior and
 - (2) Cut end of the same integral ambient tube. Cut end tube was unobstructed.

EQA 8814R



Figure 183: Skin distortion at valve mounting location.



Figure 184: Exterior opening, close-up of fracture of valve housing at forward/upper hinge pin.



Figure 185: Exterior opening, close-up, another view of figure #184

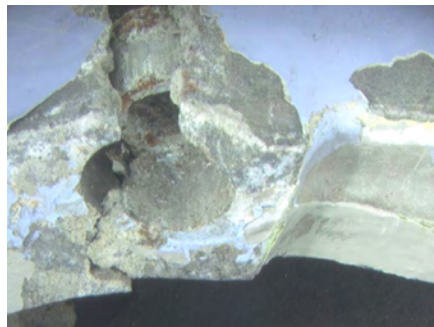

Figure 186: Forward/upper hinge pin bushing hole.

- Housing is cracked and contains partial bushing.

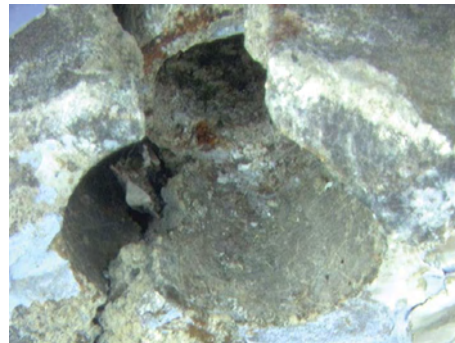

Figure 187: Forward/upper hinge pin, close-up of partial bushing.

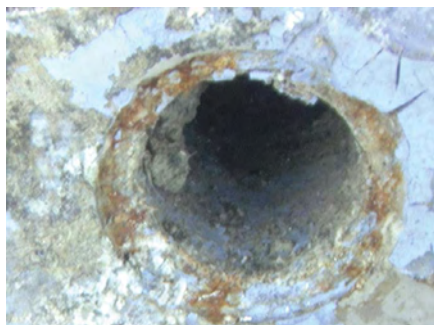

Figure 188: Forward/upper hinge pin, close-up view of partial bushing in hole.

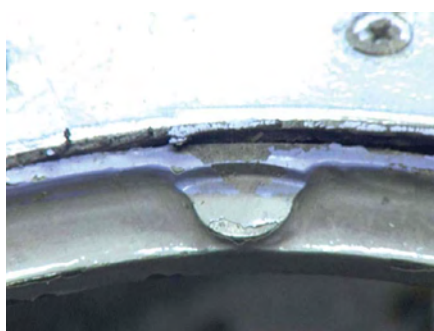

Figure 189: Exterior opening, close-up, upper door stop pad.

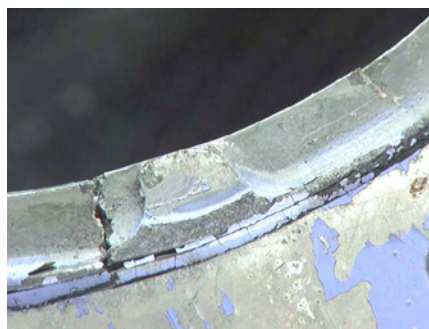

Figure 190: Exterior opening, close-up, upper door stop pad.



Figure 191: Upper stop pad; paint chipped.

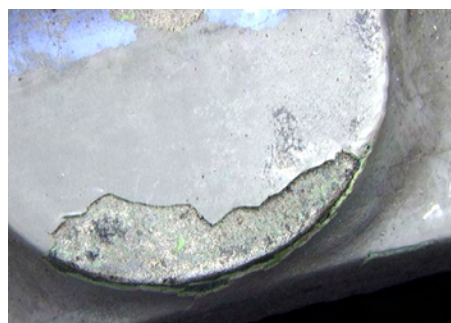

Figure 192: Upper stop pad, close-up of figure #191.

EQA 8814R

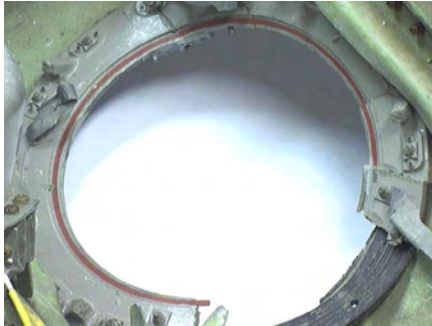

Figure 193: Non-metallic washer (gate seal), HS P/N 527355-13, as viewed from inside.

- Approximately 25% of seal is missing.
- Slight impression of gate knife-edge on seal surface.
- No abnormal cuts on seal surface.

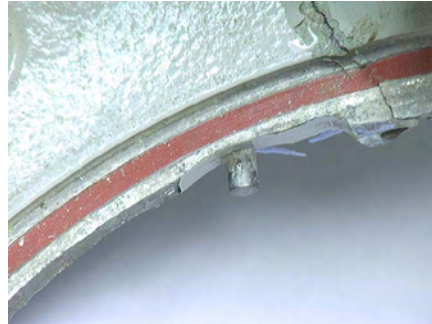

Figure 194: Exterior door open, stop pin, HS P/N 730539-1. Overview of forward/upper pin as viewed from inside.

- Appears to be normal and not bent relative to valve housing.



Figure 195: Forward/upper stop pin overview. View is looking from inside towards outside.

- Pin is relatively straight.



Figure 196: Forward/upper stop pin; close-up view of figure #195.



Figure 197: Forward/upper stop pin, close-up view of figures #195 and #196.



Figure 198: Forward/upper stop pin as viewed from outside looking inside..

- Pin is relatively straight.

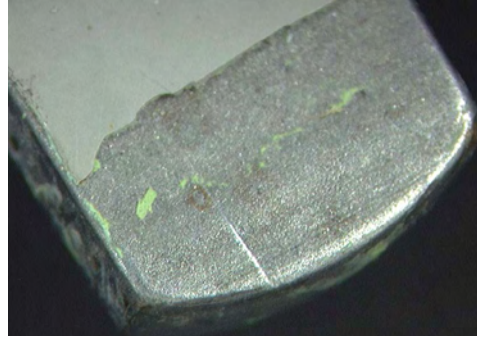

Figure 199: Forward/upper stop pin, close-up of figure #198.

- Paint is chipped.



Figure 200: Lower stop pad, with adjacent crack on housing.



Figure 201: Detail of lower stop pad.

- It is broken away from housing (housing cracked).



Figure 202: Close-up of figure #200, paint chipped.



Figure 203: Close-up of figures #200 and #202, slight dent on pad, paint chipped.

EQA 8814R



Figure 204: Exterior door open, forward/lower stop pin, HS P/N 730539-1, as viewed from inside.

- Appears to be normal and not bent relative to valve housing.
- Note: aft upper & lower pins are missing along with a portion of valve housing that they are normally installed in.



Figure 205: Forward/lower stop pin, overview as viewed from inside.

- Pin is relatively straight.

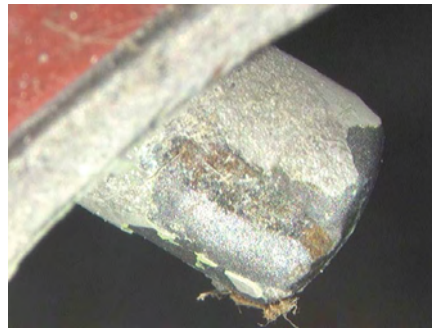

Figure 206: Forward/lower stop pin; close-up of figure #205.



Figure 207: Forward/lower, stop pin as viewed form outside.

- Pin is relatively straight.
- Paint is chipped.



Figure 208: Forward/lower, stop pin, close-up of figure #207.



Figure 209: Hole penetrating support housing, HS P/N 727405-1.

- Hole is approximately 0.365 inch x 0.560 inch.



Figure 210: Electrical switch connector interface appears to be intact.

- Wires are intact exiting plug.
- Strain relief on backshell is broken.

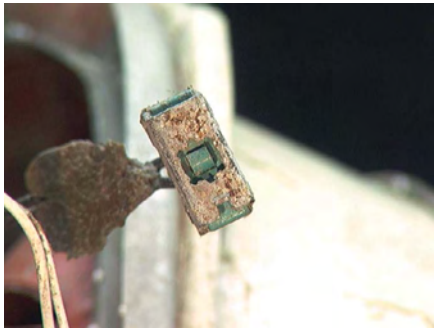

Figure 211: Switch plunger, part of HS P/N 727415-1.

- Switch appears to be intact but switch actuator is missing.



Figure 212: Switch (side view): actuator is missing from switch housing.



Figure 213: Switch lead wires showing bond detached from housing.



Figure 214: Lower Pressure Relief Valve; detail of valve gate, switch contact area.

EQA 8814R

Test results:

- Checked continuity of switch:

Ends of lead wires stripped to perform continuity check.
Continuity verified in the normally relaxed condition, per normal installation.
When plunger was depressed, switch changed state (of circuit).



Figure 215: Overview of removed valve.

- Gate adapter is out of round.
- Web members have rotated approximately 45° in relation to case.
- Approximately 50% of edges were curled & torn.
- Light salt deposits.
- At attachment to gate HS P/N 727407-11, 50% of sealant is cracked.
- All 8 rivets (attaching gate to gate adapter) are intact.
- 2 of 4 spacers HS P/N 727407-30, are broken off at flanges.
- HS P/N 727407-11, gate – all 8 of center body webs are broken (7 of 8 at the inside diameter [ID] of the gate).



Figure 216: Gate webs, detailed view of broken web members.



Figure 217: Broken web detail.



[Figure 218](#): Web damage.



[Figure 219](#): Web damage.



[Figure 220](#): Detail of more broken webs.



[Figure 221](#): Knife-edge close-up of damage.



[222](#): Knife-edge damage.



[Figure 223](#): Knife-edge damage.

EQA 8814R



[Figure 224](#): Knife-edge damage.



[Figure 225](#): Knife-edge damage.



[Figure 226](#): Knife-edge damage.



[Figure 227](#): Outer diaphragm HS P/N 727403-1, torn location.



[Figure 228](#): Outer diaphragm, approximately 60% of circumference is torn.



[Figure 229](#): Outer diaphragm, torn location.



Figure 230: Outer diaphragm damage.



Figure 231: Outer diaphragm damage.



Figure 232: Side view of gate assembly & valve cover, showing the approximate 30° angle between gate assembly & valve cover.



Figure 233: Outer diaphragm, close-up of tear origin.



Figure 234: Outer diaphragm, intact (not torn) portion.



Figure 235: Center diaphragm, HS P/N 727401-1 appears to be intact and the bond portion can be seen; looks normal.

EQA 8814R



Figure 236: Gate return spring, HS P/N 727414-2 appears to be intact.

- Some unknown surface accumulation is present.



Figure 237: Gate return spring is seated in the gate. The end coil appears to be inside the last active coil.



Figure 238: Gate return spring is over end showing intertwining of end coil and the active coil.

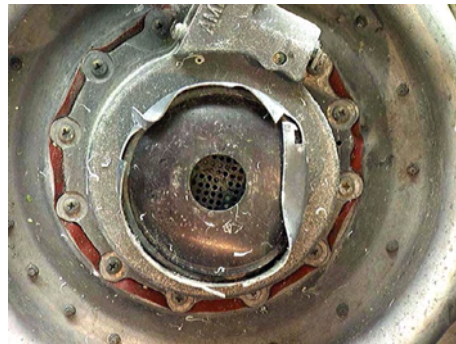

Figure 239: Overall of control, filter end.

- Filter cover HS P/N 727423-1 & spring HS P/N 727430-1 are missing.
- Filter housing HS P/N 727426-1 is bent over holding filter in place.

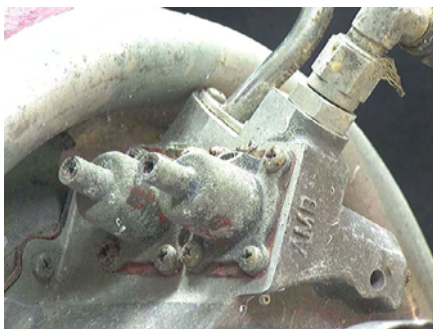

Figure 240: Control assembly area (sense housing area), overview.

- Intact, some surface accumulation.
- Nothing looks out of place.
- Integral ambient sensing tube attachment looks normal.
- Remote tube attachment looks normal.

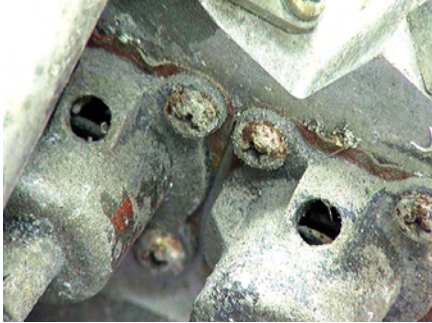

Figure 241: Cabin pressure sense ports.

- Ports appear to be un-plugged.
- Some accumulation deposits.
- Springs appear to be in place.



Figure 242: Control adjustment screws, both appear to be intact.

X-rays of Lower Pressure Relief Valve:

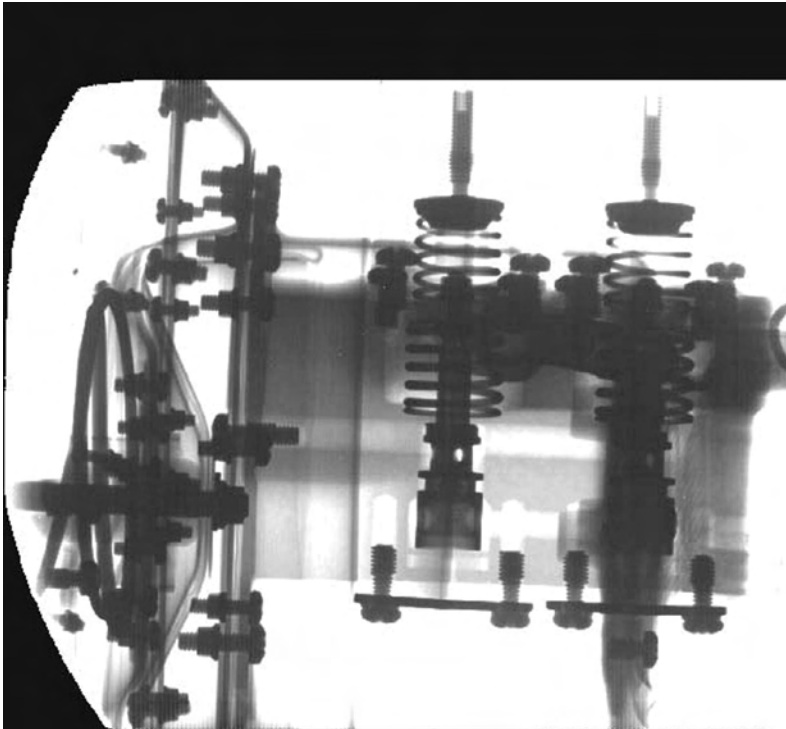

Figure 243: Lower Pressure Relief Valve, control assembly x-ray.

EQA 8814R



Figure 244: Integral sense control, adjustment spring.



Figure 245: Remote sense, control, adjustment spring.

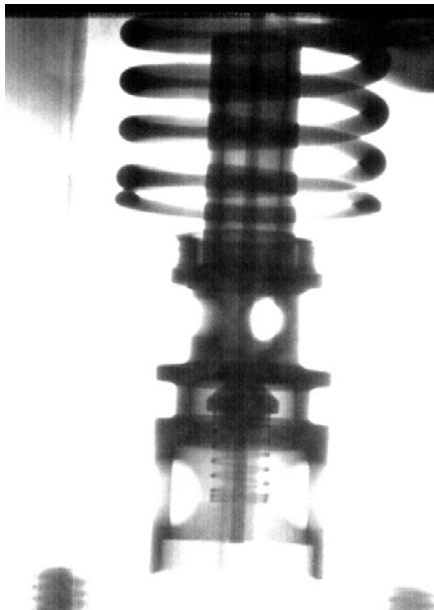
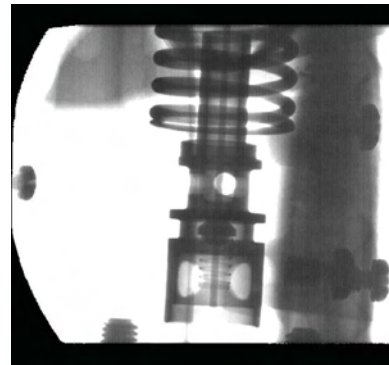
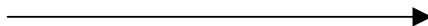

Figure 246: Integral sense control poppet..



Figure 247: Upper Pressure Relief Valve, control assembly x-ray.



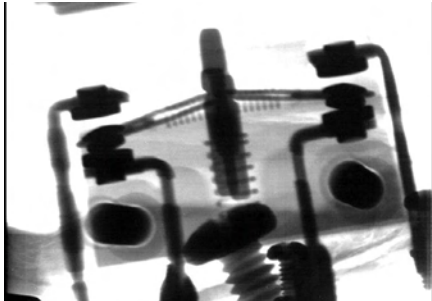

Figure 248: Lower Pressure Relief Valve, closed valve switch; "Not Closed" contacts.

Disassembly and Test Observations

- Removed sensor cover (HS P/N 747525-1) from remote ambient sensor.



Figure 249: Remote ambient sensor, cover and diaphragm partially removed.

- Heavy salt deposits on spring, piston and diaphragm.



Figure 250: Showing remote ambient sensor removed.

- Heavy salt deposits on spring & housing bore.
- Diaphragm appears to be intact, poppet moves freely.



Figure 251: Close-up of salt deposits inside housing bore.



Figure 252: Remote ambient sensor, opposite end of poppet and guide.

EQA 8814R



Figure 253: Plug HS P/N 719280-1 and seal, seal looks normal and uncut.



Figure 254: Integral sensor housing bore.

- Heavy deposits.
- Poppet appears to be frozen.
- Salt deposits on end of poppet.



Figure 255: Integral sensor spring and diaphragm.

- Heavy salt deposits.
- Diaphragm intact.
- Spring has heavy salt deposits and possibly salt corrosion.



Figure 256: Opposite end of integral sensor poppet and guide; heavy salt deposits.



Figure 257: Plug for integral sensor, seal looks normal and uncut.

ITEM F.

Identification: **Pressure Relief Valve –
Comparison Unit provided by Hamilton-Sundstrand**

Supplier: Hamilton Sundstrand
Boeing P/N: 60B00025-19

* This pressure relief valve was a rotatable stock unit (not new) supplied by Hamilton Sundstrand for comparative purposes during this examination. This unit was used as a representative of a functionally acceptable unit for x-ray evaluation.

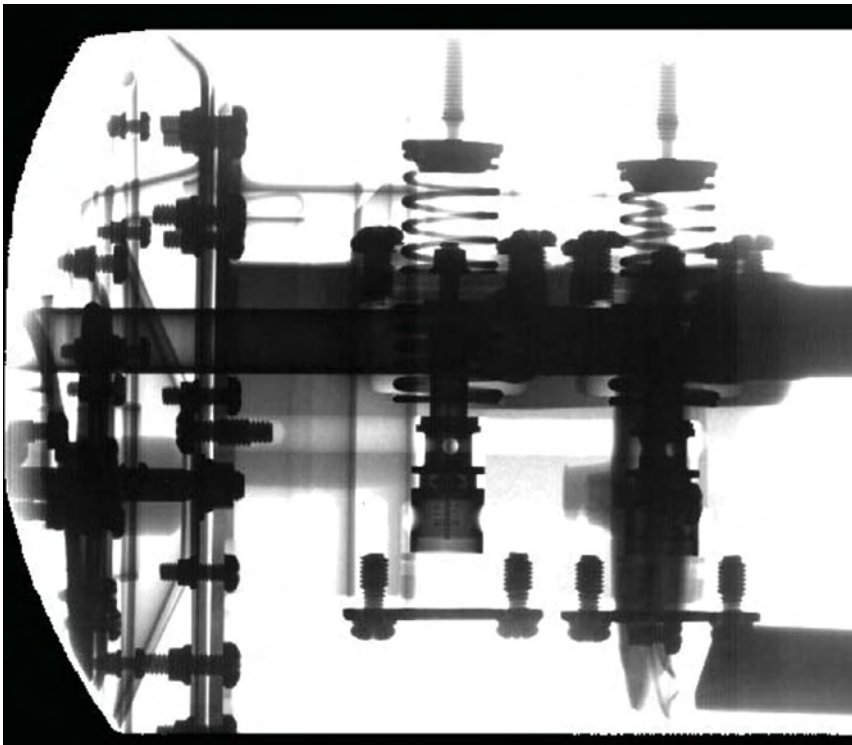
X-rays of Sample Comparison Pressure Relief Valve:

[Figure 258](#): Comparison Pressure Relief Valve, control assembly x-ray.

EQA 8814R



[Figure 259](#): Integral control adjustment spring.

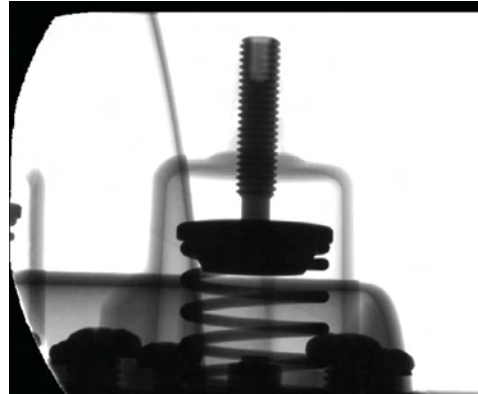

[Figure 260](#): Remote control adjustment spring.

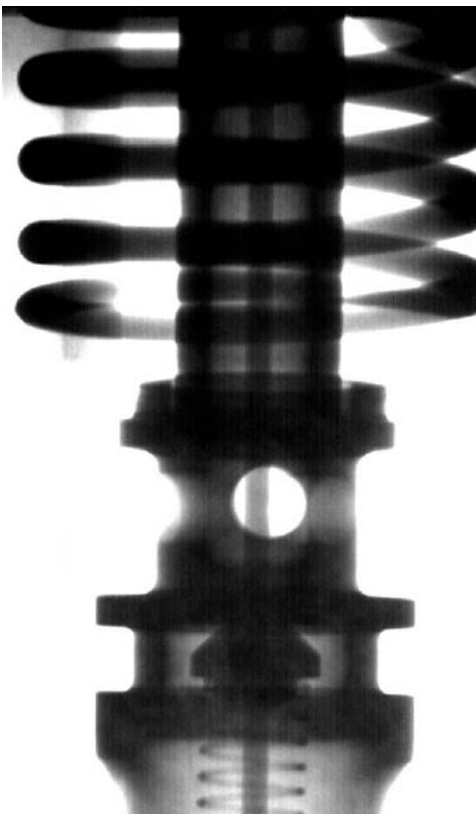

[Figure 262](#): Integral control poppet.

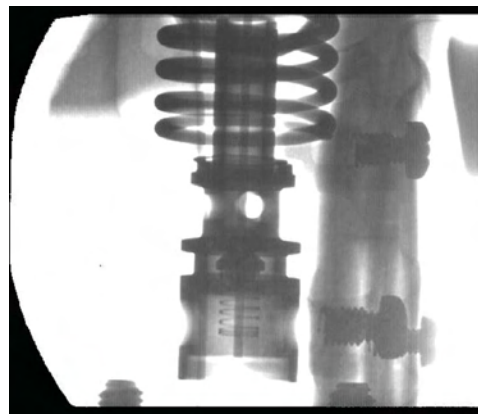

[Figure 261](#): Remote control poppet.

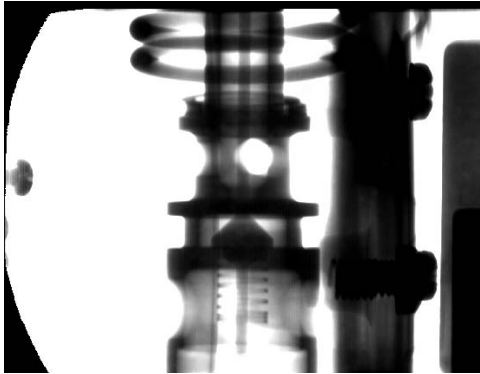

Figure 263: Remote control vacuum.

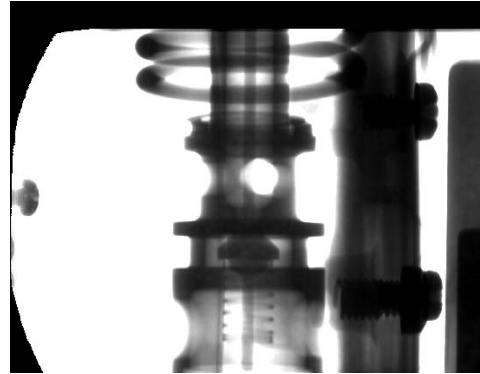

Figure 264: Remote control non-vacuum.



Figure 265: New switch, closed valve, not closed contacts.

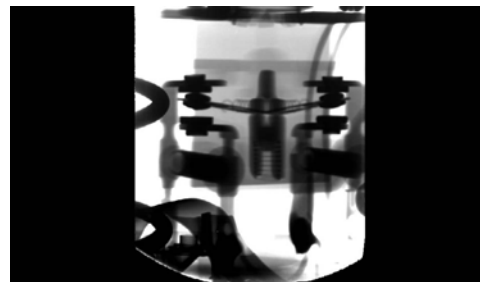

Figure 266: New switch, open valve, closed contacts.

- The following force tests were performed on the new pressure relief valve, flapper doors to measure the forces that were required to move the flapper doors under various test conditions.



Figure 267: Comparison unit*, door A tension, 2.85 pounds (opening force from center edge of door).



Figure 268: Comparison unit*, door B tension, 2.90 pounds (opening force from center edge of door).

EQA 8814R



Figure 269: Comparison unit*, door A compression (closing), 1.90 pounds (push at center of door to close door).



Figure 270: Comparison unit*, door B compression (closing), 1.95 pounds (push at center of door to close door).



Figure 271: Comparison unit*, both doors open, closing one, 1.90 pounds (pulling at center of door).



Figure 272: Comparison unit*, customer request, single door cusp, 3 pounds peak to get to neutral (in view) from the open position.



Figure 273: Comparison unit*, customer request, double door cusp, manually set to hold in "neutral".

ITEM G.

Identification

Unidentified Items



Figure 274. Appears to be a portion of a gear/cam assembly and structure.



Figure 275. Appears to be a portion of a gear/cam assembly and structure, different view from figure #274.

Figures 274 and 275:

Two unidentified parts

- Opened bubble wrapped package with two unrelated parts (free from panels). Contains one cam detail and a small piece of structure.
- Parts are unidentified and are not part of this examination but are documented because they were received in the boxes.

The preceding information is being submitted to the appropriate personnel for information purposes. The EQA group plans no further action at this time. This EQAR is considered closed.

附錄 15 中科院材料測試報告－中文版

材料試驗報告(Materials Test Report) 續頁

一、說明

圖 1 是飛安會送至本所分析的編號 640C 殘骸外觀，其中包含 640C1 與 640C2。本文首先就委託的 640C 殘骸做破壞外觀的現象描述，並針對疲勞裂縫區域的確定、裂縫起始點、裂縫擴展特徵與材質分析等項目做進一步分析，以期能完善的提供研判失事分析的依據。

二、目視檢查

圖 2 是 640C1 殘骸外觀的兩面，此件除了機身蒙皮外，在蒙皮外側另有修補用的外加補片(doubler)，補片的位置大致介於 STA 2060~2180 框架(frame)，以及編號 S-49L 至 S-51R 兩肋(stringer)之中間，圖 2 中有標示修補片的邊緣位置。圖 2a 是 640C1 機身蒙皮內側外觀，顯示所有的框架均與蒙皮脫離，但除了編號 S-50L 介於 STA 2120~2140 的一段肋已經脫離外，絕大部分的肋尚附在蒙皮上。藉由目視檢查發現在蒙皮的某些破斷面有疑似疲勞的現象(破斷面與蒙皮表面幾乎呈垂直關係)，此疑似疲勞破斷面位於 S-49L 的左側與補片邊緣間，而且幾乎與 S-49R 平行，如圖 2a 中紅色箭頭所指的位置。

圖 3 是圖 2 中沿著 S-49 肋方向之蒙皮破斷面巨觀相片，此圖是由 18 張相片所組成，以便能宏觀的呈現所有破斷面特徵。圖 3 為區別破斷面的位置，將區域內的鉚釘使用編號從+17~91 加以標記，全文均使用相同的編號方式。

三、巨觀觀察

圖 3 中編號+17~91 間的破斷面首先使用低倍率巨觀顯微鏡觀察，以大致先確定疲勞的區域，然後再使用 SEM 觀察編號+17~56 間的破斷面，以進一步分析破斷面的疲勞區域、裂縫起始點與裂紋擴展方向等。整個蒙皮破斷面的巨觀觀察分成如圖 4 所示的三個試片分別執行，圖 4a、4b 與 4c 試片的區域其鉚釘編號分別是+17~30，31~56 與 57~97，三個試片是包含修補片與蒙皮一起觀察，是以電鋸自 640C1 殘骸中將三者取出。巨觀觀察是在航空研究所材料實驗室執行，下列單位共同參與此項的巨觀觀察工作

- (1) 美國運輸安全委員會
- (2) 波音公司
- (3) 飛航安全委員會
- (4) 中華航空公司，+17~30
- (5) 中科院航空研究所

材料試驗報告(Materials Test Report) 續頁

四、掃描式電子顯微鏡觀察

掃描式電子顯微鏡主要針對鉚釘編號+17~56 區域的破斷面(圖 4a、4b)做進一步的分析以確認疲勞裂縫區域範圍、裂紋起始點及裂縫擴展方向等。至於 56~91 鉚釘區域的破斷面(圖 4c)在巨觀觀察時發現非常少許的區域有疑似疲勞破壞的痕跡，但尚未使用掃描式電子顯微鏡做進一步的觀察。

為使試片置入 SEM 內觀察，將+17~56 的蒙皮破斷面切成適合的尺寸，在絕大部份情形下是沿著鉚釘孔位切開，以儘量減少破壞破斷面，但其中有一個例外情形，在靠近 14 號鉚釘的位置，因此段的試片太長而將破斷面切開。

修補片及蒙皮分開時，須將圖 4a、4b 試片的鉚釘全部拆解，其程序如下：(1)使用比鉚釘頭直徑更小尺寸的鑽頭(防止傷害到鉚釘的孔洞)先行在鉚釘頭部位鑽至固定的深度，(2)使用氣槍將剩餘鉚釘頭部位與其它部位分離，尾部則未受損傷的脫離孔的位置。

由於破斷面污染相當嚴重，因此 SEM 觀察前須清洗破斷面，首先使用塗上樹脂(Duco cement)的膠帶(replicating tape)黏貼破斷面，並用力使兩者均勻接觸，儘可能將破斷面上的污染物去除，然後再將試片放入丙酮中使用超音波清洗，此清洗方式雖然使破斷面的觀察工作大幅改善，但因破斷面氧化嚴重，在 SEM 中尚有許多破斷面的位置無法觀察其特徵，因此最後針對每一試片均使用波音公司提供的鉻酸溶液清洗破斷面上的氧化物，以利 SEM 觀察。在 SEM 觀察的期間，大部份情形在波音的代表陪同下共同執行。

五、結果與討論

- SEM 觀察結果的疲勞區域範圍如圖 5~10 所示，破斷面中黑色曲線的下方便是代表疲勞區，超過曲線的區域是典型強制破壞斷面，其中數字代表區域內最大疲勞裂縫深度佔蒙皮厚度的百分比，100%則表示疲勞已貫穿整個蒙皮厚度。所有蒙皮破斷面的疲勞裂縫均從鉚釘孔附近開始產生，而且裂縫起始點均位於與修補片交接的蒙皮外側表面邊緣上，然後再沿厚度方向往蒙皮內側進行。疲勞最嚴重的區域位於 STA 2100 的框架兩側，是屬於編號 10~25 鉚釘間的破斷面。圖 11 是+11~56 破斷面中疲勞區域的整體示意圖。
- 圖 12 是 25 號鉚釘孔附近之 5 張不同倍率掃描式電子顯微鏡(SEM)相

材料試驗報告(Materials Test Report) 續頁

片，其中在高倍率的 SEM 相片中可清楚看見疲勞紋(striation)特徵，如圖 12e 與 12f 所示，圖 12f 中更可觀察到位於兩條粗疲勞間夾有更細的疲勞紋，其中粗疲勞紋的間距約 $2\mu\text{m}$ ，細疲勞紋間距約 $0.5\mu\text{m}$ ，基本上此兩種不同間距的疲勞紋乃對應兩種不同型態的反覆負荷。圖 12b 白方框的位置離蒙皮的內側表面約 $200\mu\text{m}$ ，此位置所對應的蒙皮厚度約 $1800\mu\text{m}$ ，是屬於沿厚度方向裂縫擴展的較後段區域，因此圖 12d 與 12e 中除了顯示疲勞紋外，亦有凹渦(dimple)的特徵。圖 12b 中在緊鄰修補片的蒙皮外側邊緣上發現有相當多的棘輪痕跡(ratchet mark)，表示此位置存在非常多的疲勞裂縫起始點，圖 12b 中的藍色箭頭所指的位置代表裂紋起始點，黃色箭頭代表裂紋行進方向，顯示整個裂紋大致上是由蒙皮的外側表面沿厚度方向往內側擴展，下面文中的圖示均使用相同方式的箭頭標示裂縫擴展方向與起始點。

3. 圖 13 是編號 25 鉚釘孔兩側的掃描式電子顯微鏡相片，裂紋起始點與擴展情形與圖 12 的特徵相同，同樣具有多起始點特徵，且起始點皆位於緊鄰修補片的蒙皮外側表面邊緣位置，疲勞裂紋的擴展主要是沿厚度方向進行，而且幾近完全貫穿蒙皮厚度。從裂紋擴展的方向可研判編號 25 鉚釘兩側區域內最早產生裂紋的地方大約位於黑色橢圓位置，此位置在蒙皮厚度方向的對應點落在鉚釘尾部壓平後之環形邊緣下方。
4. 圖 14 是 14 號鉚釘孔附近之破斷面掃描式電子顯微鏡相片，大致上此區域的疲勞破壞特徵與前面所述之 25 號鉚釘孔附近破斷面非常類似，如裂縫起始點與擴展方向，圖 14b 中藍色箭頭所指的位置均為裂紋起始點，圖 14b 中三個小正方形黑點的 SEM 放大相片如圖 14c~14e 所示，三點所在位置的蒙皮厚度約 $1750\mu\text{m}$ 。圖 14c 中疲勞紋的位置約 $250\mu\text{m}$ ，圖 14d 的位置約 $1020\mu\text{m}$ ，圖 14e 的位置約 $1480\mu\text{m}$ ，以上三點位置的距離均從緊鄰補片的蒙皮外側邊緣做為參考位置。上述的疲勞紋密度數據可估算疲勞裂紋貫穿 14 號鉚釘孔附近蒙皮所需的週期，若可判定此應力來源，即可研判此疲勞裂縫產生的時間。
5. 圖 15 是編號+5 鉚釘孔左側的掃描式電子顯微鏡相片，此位置的疲勞破壞特徵與前面所描述在 25 與 14 號鉚釘孔附近的破斷面非常類似，其間的差異是此位置的疲勞破壞區的面積較小。圖 15 中黃色箭頭代表裂紋的擴展方向，藍色箭頭代表裂紋起始點，裂紋同樣具有多起始點特徵，且位於緊鄰補片的蒙皮外側表面位置。圖 15 中的小正方形黑點位置的較高倍率電子顯微鏡相片如圖 15c 與 15d 所示，圖 15c 顯示有明顯的疲

材料試驗報告(Materials Test Report) 續頁

勞紋，在圖 15c 中箭頭所指位置的疲勞紋間距約 $6\mu\text{m}$ ，此位置離蒙皮邊緣的起始點位置約 $530\mu\text{m}$ ，圖 15d 顯示具凹渦(dimple)的強制破壞特徵。疲勞區域離蒙皮邊緣的最遠距離約佔蒙皮厚度的 30%。從裂紋擴展的方向可研判編號 25 鉚釘左側區域內最早發生裂紋的地方大致位於黑色橢圓區域。

6. 圖 3 破斷面的裂縫擴展大致上可分成兩種類型，第一類型是疲勞裂縫，其主要是從緊鄰補片的蒙皮表面沿厚度方向往內側表面進行，如前面 2、3、4 點所顯示的特徵，編號 10~25 區域的絕大部份破斷面均屬之，或在其他鉚釘孔附近的疲勞破壞均具有相同的裂縫擴展特徵。另一類型的裂縫進行方向如圖 3 中黃色箭頭所示，大體上裂縫進行的方向是從編號 10~25 的區域往兩邊擴展，此類型的破壞機構均為強制破壞。在大部份的強制破壞區域，裂縫的擴展主要是在鉚釘的孔與孔間進行，譬如從編號 44~91 與 +1~+17 的區域，其中有少數的幾個區域例外，如編號 6~10 鉚釘間的區域，主要的原因是編號 2~6 鉚釘間具有相當大的疲勞裂縫區域，此疲勞裂縫的應力集中現象較鉚釘孔更為嚴重，因此強制裂縫的行進方向直接跳過 7~9 間的鉚釘孔，而往 2~6 鉚釘間的疲勞裂縫進行裂縫的擴展，因此針對圖 3 的破斷面而言，若有不是孔對孔進行的裂縫擴展的位置，表示在圖 3 黃色箭頭的主要強制裂縫產生前極可能即存有預裂縫於此位置的附近區域。
7. 圖 16~18 是編號 19~21 鉚釘孔附近之蒙皮表面巨觀相片，顯示與補片(doubler)交接的蒙皮外側表面有相當多的刮痕(scratch)，而且此刮痕尚被漆料所覆蓋。圖 16~18 並顯示在鉚釘孔附近的裂紋主要位於鉚釘尾部壓平後之環形的邊緣位置，從前面 SEM 的破斷面觀察結果已知疲勞裂縫的起始點均位於此環形邊緣位置，而且是相對於蒙皮厚度方向的另一邊，於緊鄰補片的蒙皮外側表面邊緣上，因此鉚釘壓平的程序可能在此位置產生殘留拉應力(residual tensile stress)。疲勞裂縫在平行 S-49L 肋的方向則顯得相當筆直，主要是沿著刮痕的位置，如圖 16 與 17 中的黑色箭頭所指示的位置，鉚釘尾部環形邊緣與蒙皮表面刮痕兩種效應均可能造成應力集中，因而降低蒙皮的疲勞壽命，但何者所佔的比率較大，或可忽略其中一項，更進一步的分析與評估實屬必要。
8. 編號 10~28 鉚釘區域的破斷面大部分屬於疲勞破壞，比較各鉚釘附近的破壞特徵非常相似，但其間在破壞位置上尚存有一些差異，如圖 7 與 8 所示，鉚釘編號 13~20 區域的疲勞裂縫的位置較靠近補片邊緣，因此鉚

材料試驗報告(Materials Test Report) 續頁

釘中間的實心部位尚位於破斷面之後，相對而言，在 13~20 的兩邊的周圍區域，如編號 10、12 與 22~28 的疲勞裂縫則離補片邊緣較遠，因而露出鉚釘中間的實心部分，而且在 22~28 的區域更是具有一點有趣的特徵，也就是鉚釘編號愈大所對應的破斷面，其露出鉚釘的中心實心部位也愈多。針對此點，編號 4~5 鉚釘部位的疲勞裂縫型態與 10~18 鉚釘相似，疲勞裂縫的位置較靠近補片邊緣，上述疲勞裂縫位置的差異可能是主應力(principal stress)方向的改變所造成。基本上圖 3 破斷面之所有的疲勞裂紋為多起始點，而且起始點均位於鉚釘孔附近，但尚無法明確研判那一個鉚釘孔附近先有疲勞裂紋產生，或是同時產生，但藉此特徵，或許可進一步研判對應不同鉚釘孔之破斷面產生疲勞裂縫的先後順序。

9. 圖 19 顯示在 STA 2100 框架(frame)附近的蒙皮與破斷面有明顯的局部嚴重變形，此變形區域所對應的破斷面正好是嚴重疲勞區，其疲勞區域幾乎貫穿整個蒙皮厚度，變形的特徵如下：

- (1) 此變形在 STA 2100 框架的所在位置最為突出，隔框兩側的位置相對而言有內凹的現象，內凹較嚴重的位置是從編號 13~18 號與 22~26 號鉚釘間的兩個區域，如前面所示，此兩個區域的破斷面正是嚴重疲勞破壞區。
- (2) 在沿框架方向(垂直 S-49L 肋)的局部變形特徵大致上是靠近補片自由端的部分較為明顯，愈往機身右側方向，較靠近 S-49L 肋的位置變形愈少，超過此肋的位置則無明顯的變形外觀。
- (3) S-49L 肋(stringer)已經斷裂，且密封膠(sealant)有局部剝離的現象
- (4) 此局部變形位置附近的補片或蒙皮表面未發現有類似外物撞擊的接觸痕跡。

10. 圖 20 是靠近局部變形破斷面的補片表面巨觀相片，其中鉚釘編號與圖 3 相同是代表相同的鉚釘，圖 20 所顯示的是補片外側鉚釘的頭部部位，圖 3 所示則是鉚釘壓接後的尾端部位，圖 20b 與 20c 顯示在編號 14~25 鉚釘區域的第二排鉚釘周圍的面漆有嚴重裂開現象，此區域正是對應如前面所提具有嚴重的疲勞裂縫的斷面，相對的，在疲勞裂縫較不嚴重的區域的補片外表面，如編號 28~91 區域，鉚釘周圍的表面面漆則無明顯的裂開現象。此表面漆的裂縫與之前所提到的局部變形可能有直接的關聯，兩者可能是同一種彎曲外力所造成。

11. 將蒙皮與補片之所有的鉚釘拆除後，並加以分離，以觀察蒙皮的表面外

材料試驗報告(Materials Test Report) 續頁

觀，圖 21 是與補片交接之蒙皮外側表面經過除漆後的相片，顯示相當多的刮痕存在於蒙皮表面，而且類似的刮痕幾乎遍佈於與補片交接的蒙皮表面上，尤其在靠近肋與框架的地方最為嚴重。

12. 圖 22 顯示靠近 1 號鉚釘之破斷面上有嚴重的磨痕情形，相對而言，在靠近+13 號鉚釘之破斷面上磨痕則顯得輕微許多，因此此位置的大部份破斷面尚可看到清楚的凹渦表徵。磨痕可能是破斷面的兩半邊互磨所造成，而且磨痕愈嚴重表示兩半邊互磨的時間也愈長。基本上強制破壞的破斷面在靠近嚴重疲勞區位置的磨痕較為嚴重。
13. 蒙皮與補片的火花放電光譜儀成份分析結果研判均為 2024 鋁合金，蒙皮材質的硬度與導電度的測試值分別為 HRB 79 與 28.5%IACS，此硬度值與導電值均符合 2024-T3 熱處理狀態的需求值，補片的材質亦是相同的熱處理狀態。

材料試驗報告(Materials Test Report) 續頁

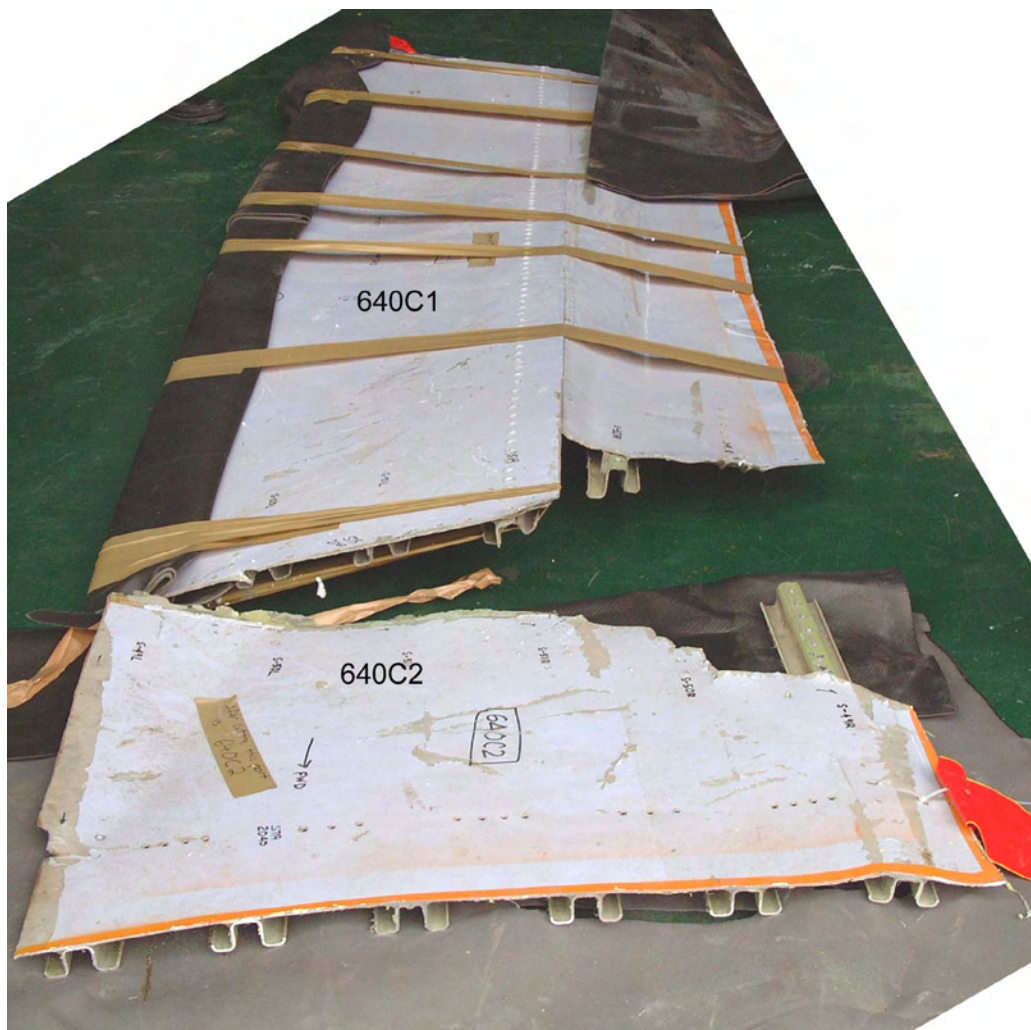
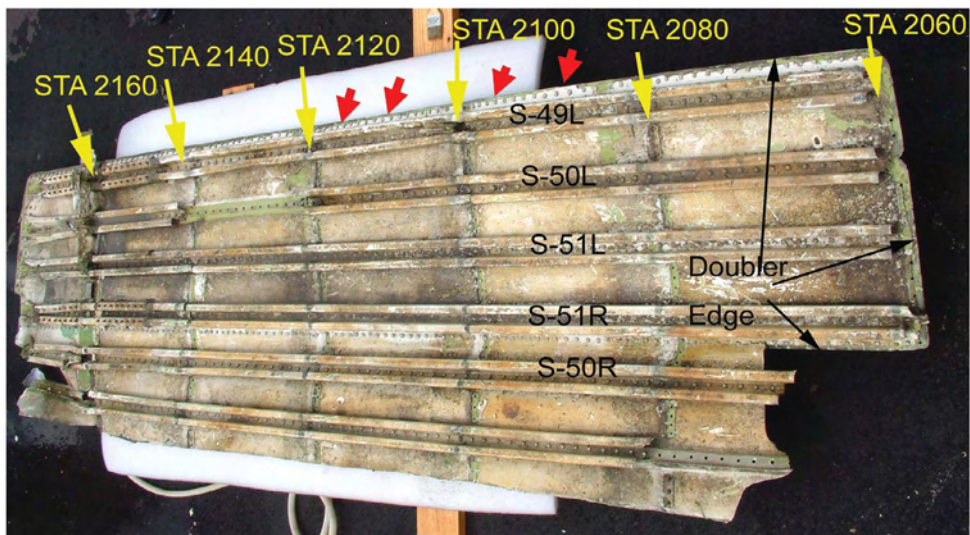
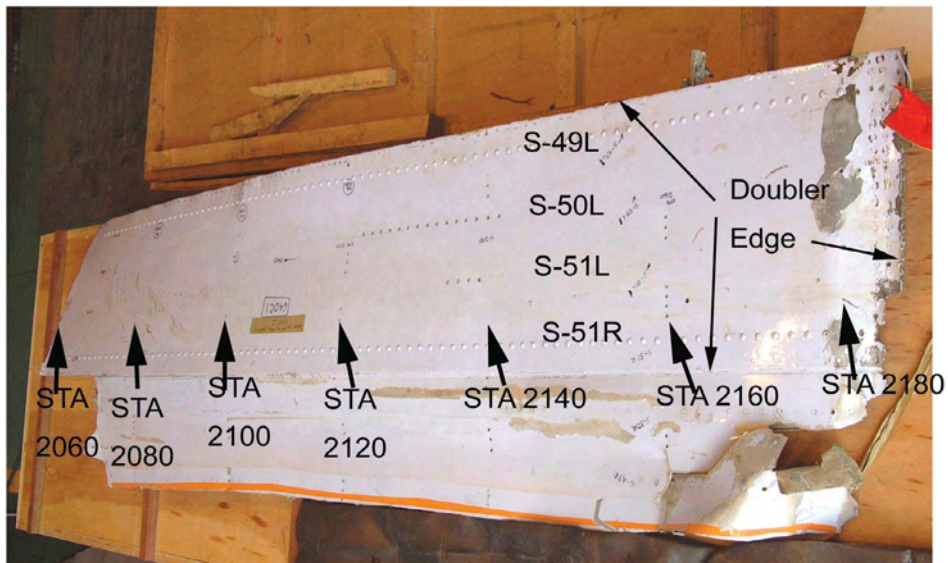

Figure 1

材料試驗報告 (Materials Test Report) 續頁

(b)



(a)

Figure 2

材料試驗報告(Materials Test Report) 續頁

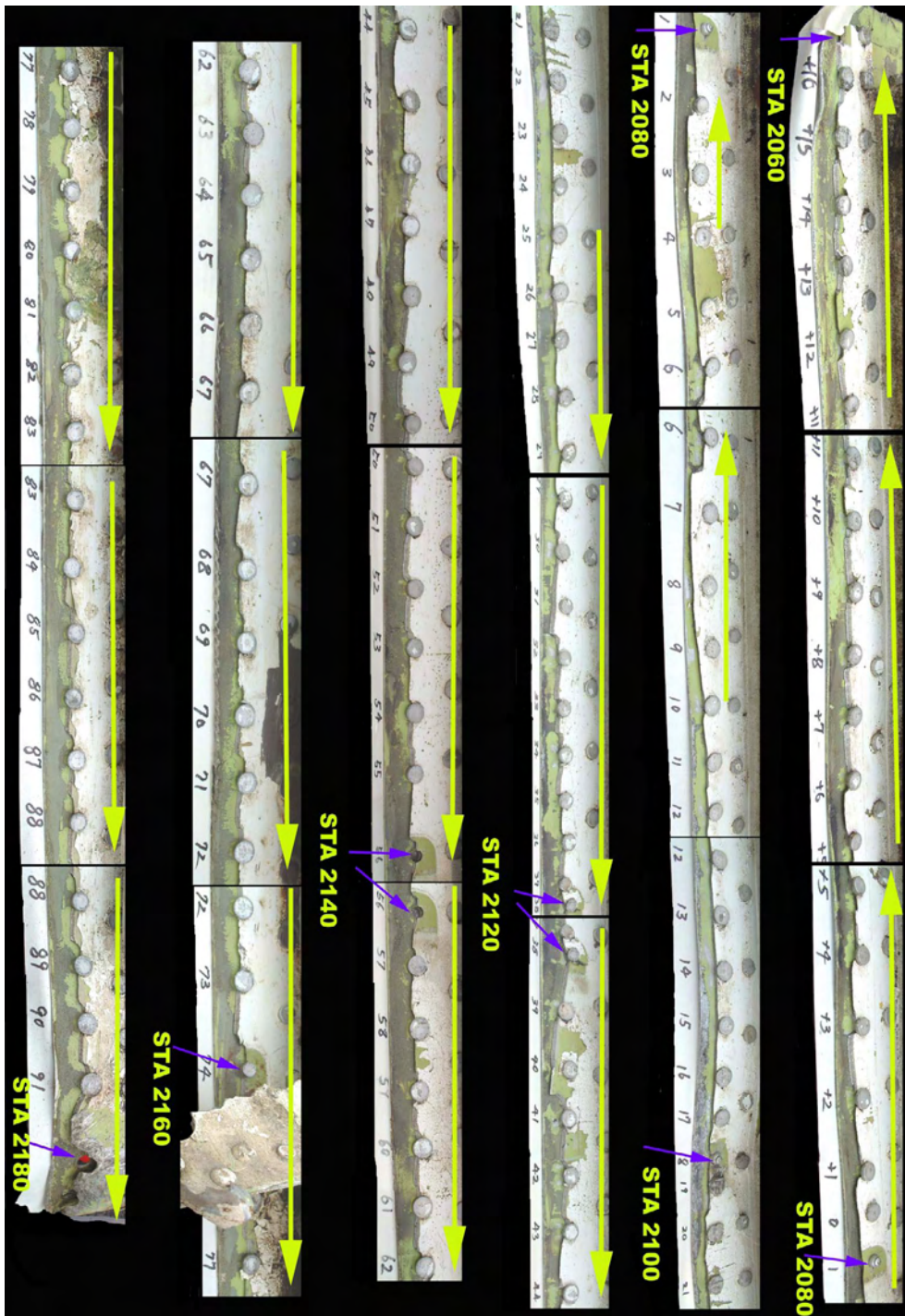

Figure 3

材料試驗報告 (Materials Test Report) 續頁



Figure 4

材料試驗報告(Materials Test Report) 續頁

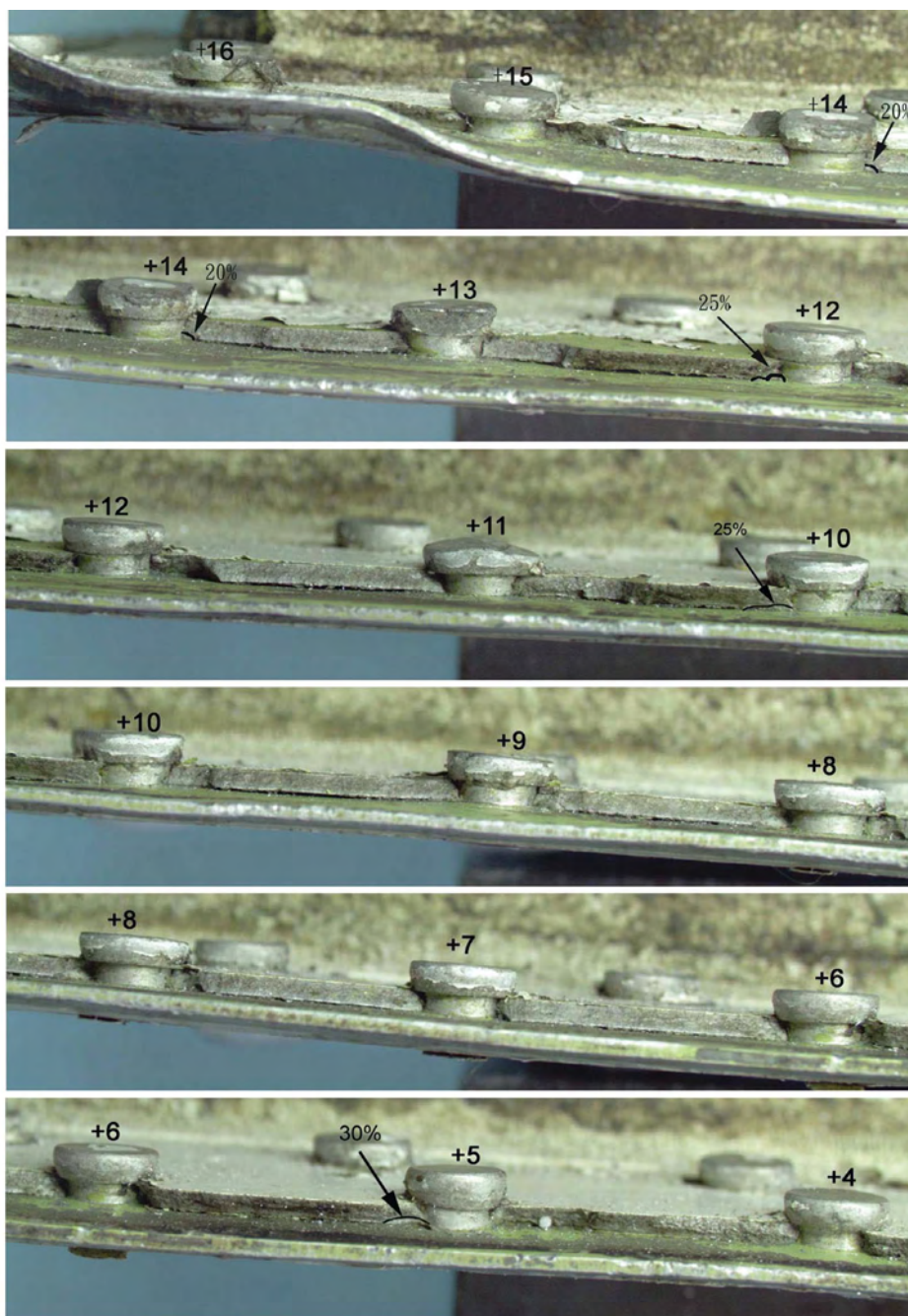

Figure 5

⊕ 材料試驗報告 (Materials Test Report) 續頁

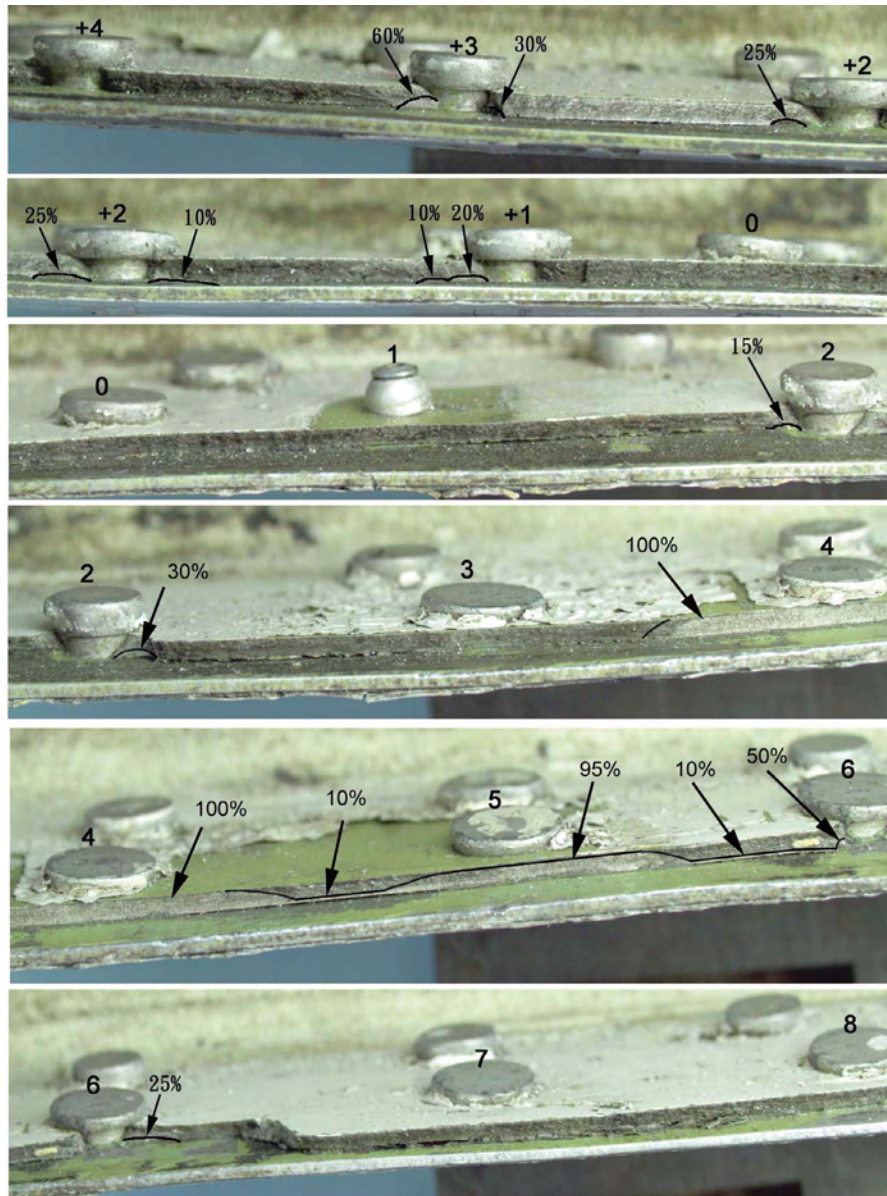

Figure 6

材料試驗報告(Materials Test Report) 續頁

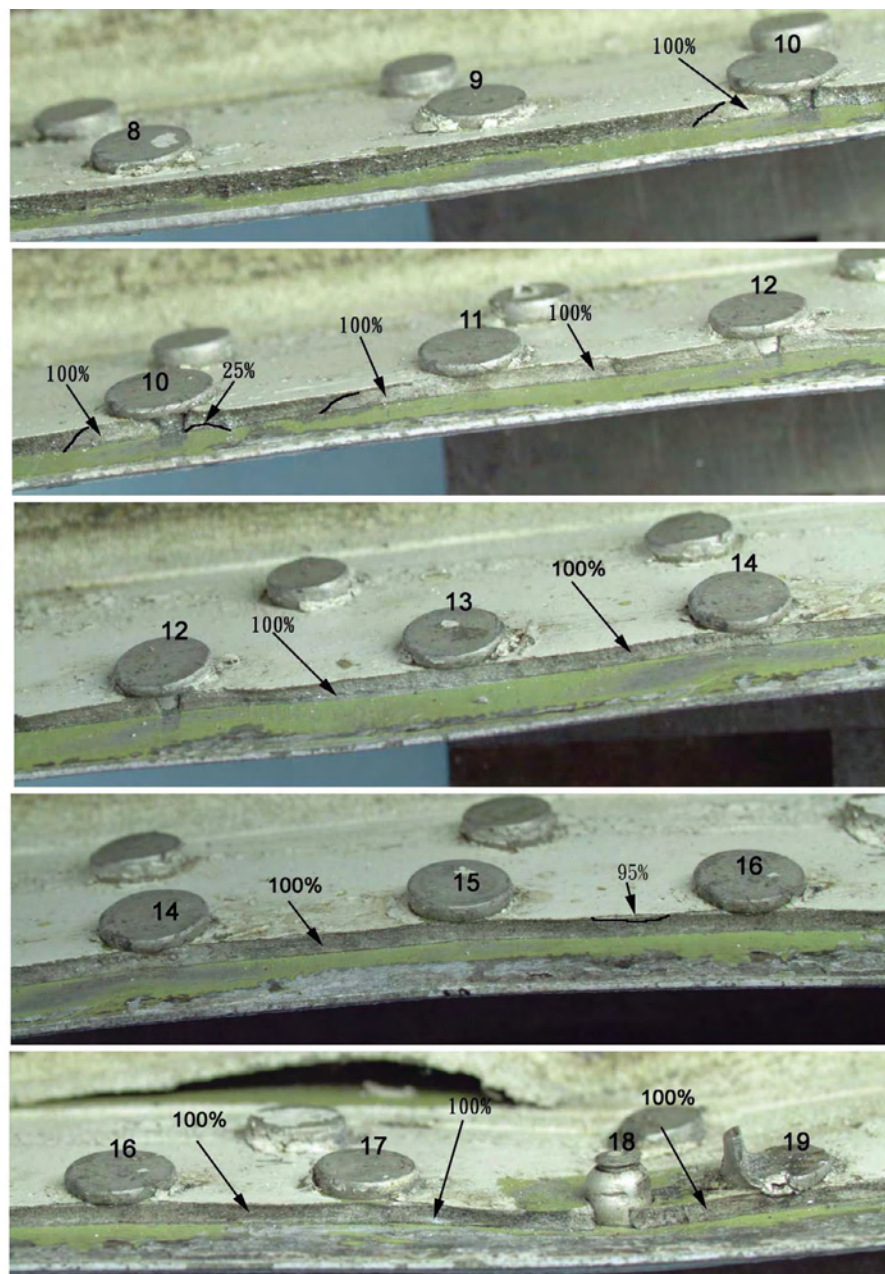

Figure 7

材料試驗報告 (Materials Test Report) 續頁

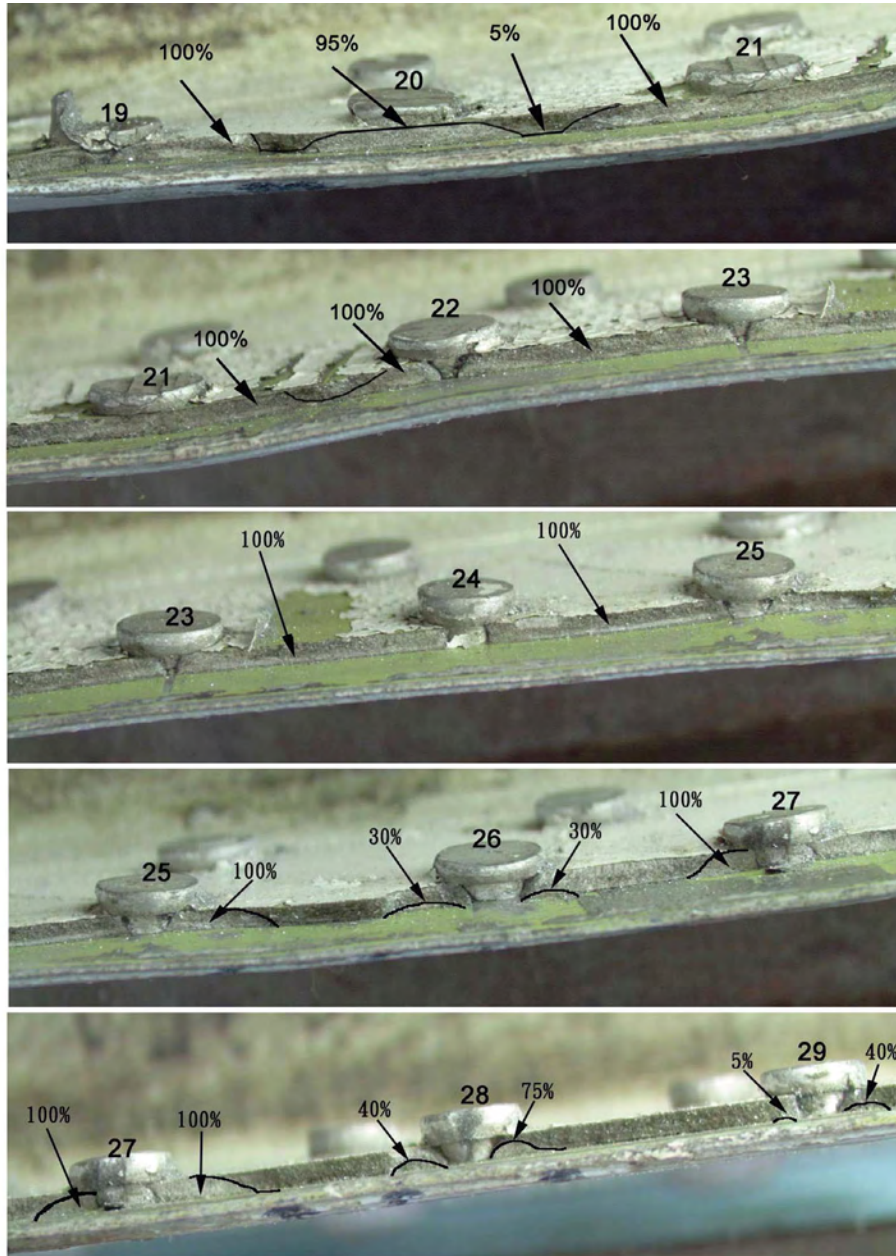

Figure 8

材料試驗報告(Materials Test Report) 續頁

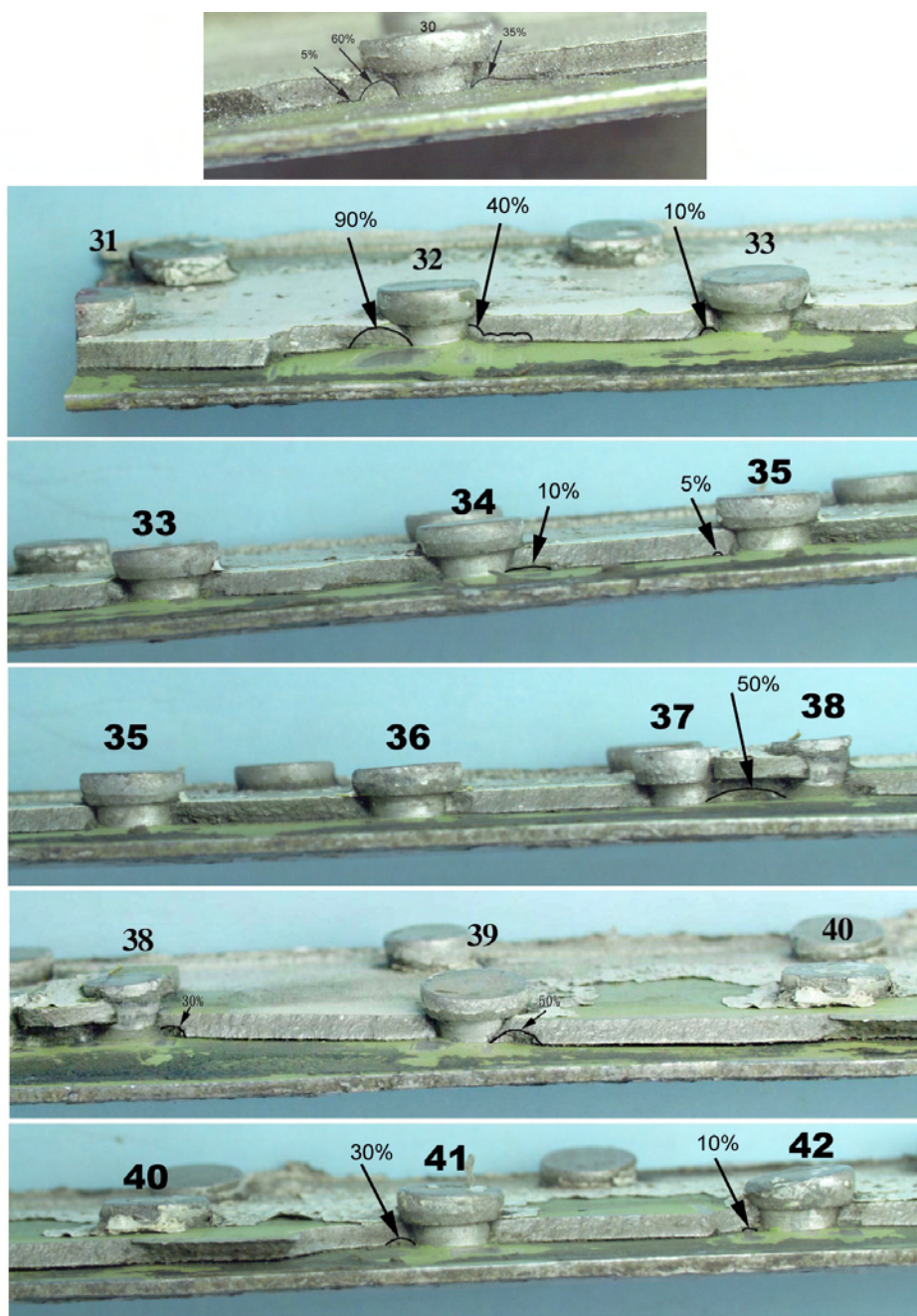

Figure 9

⊕ 材料試驗報告 (Materials Test Report) 續頁

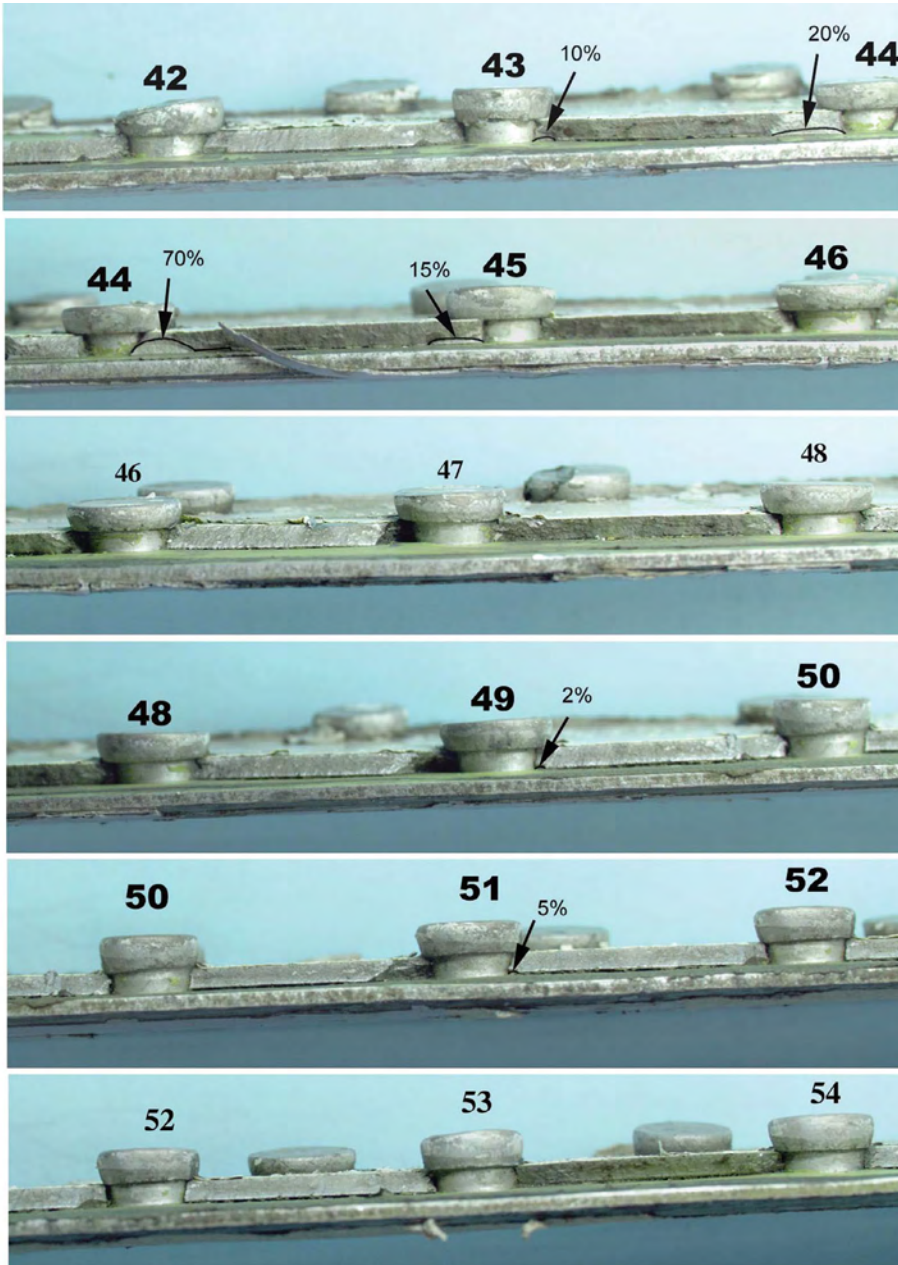

Figure 10

材料試驗報告(Materials Test Report) 續頁

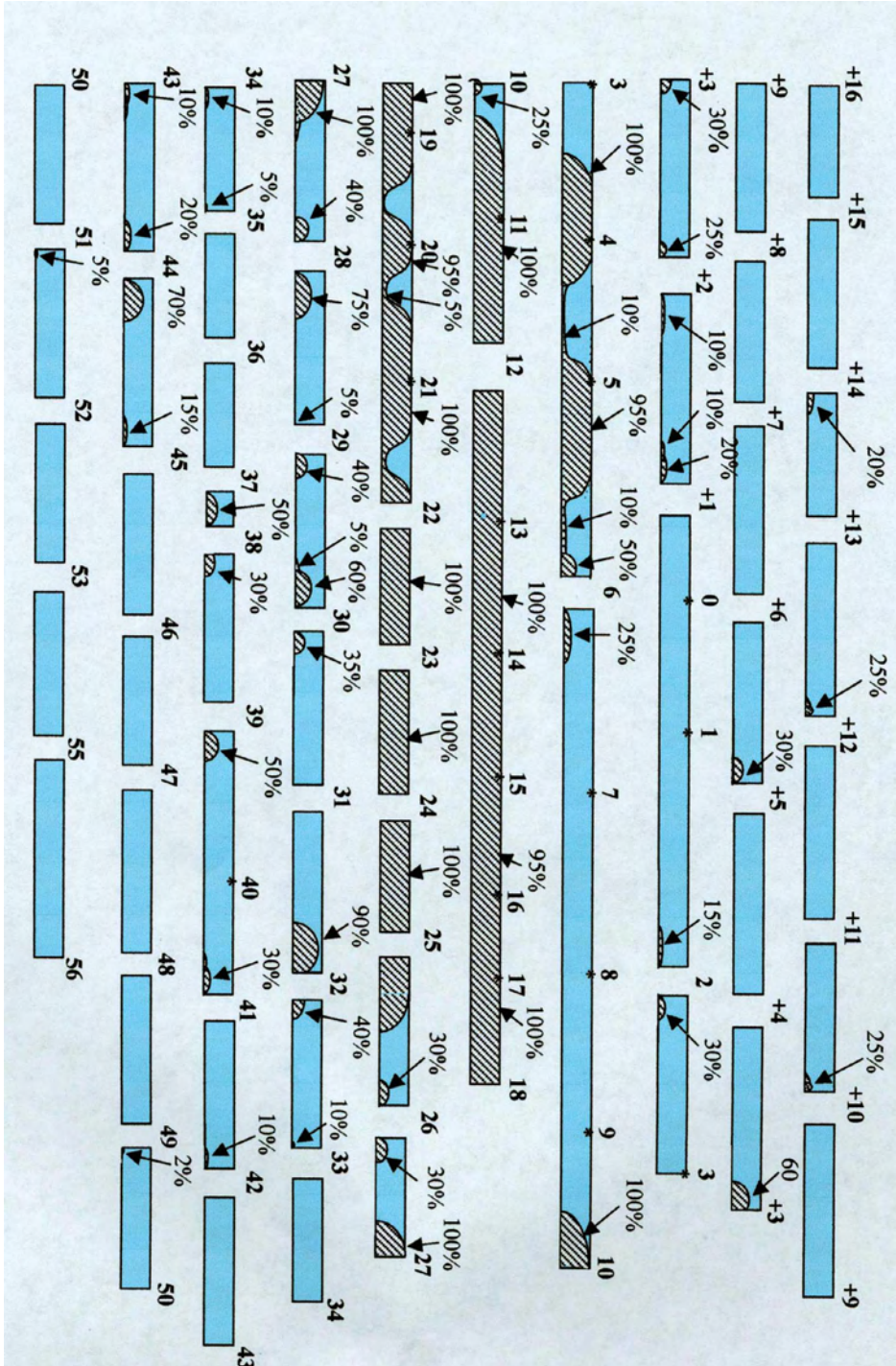

Figure 11

材料試驗報告(Materials Test Report) 續頁

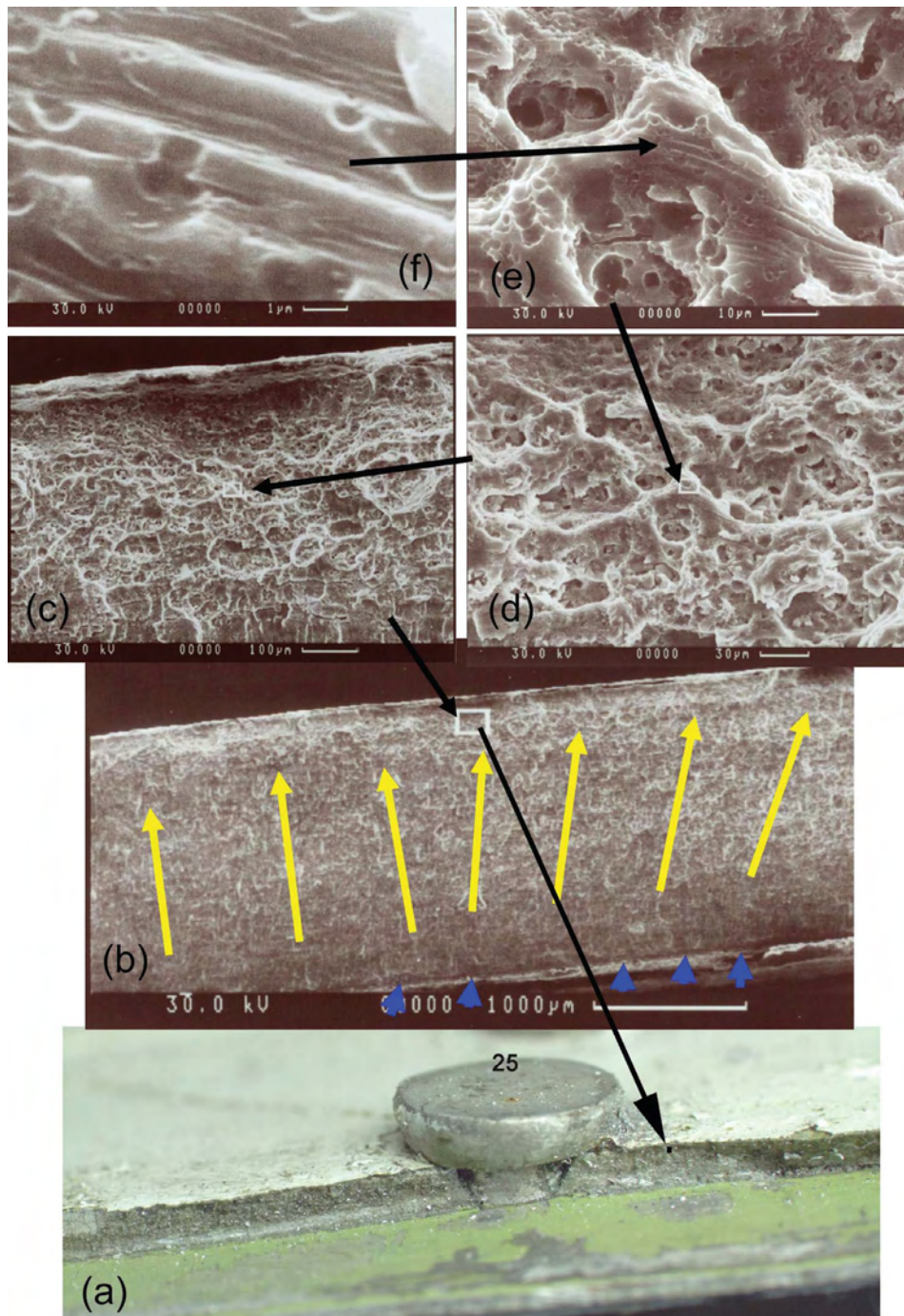

Figure 12

材料試驗報告(Materials Test Report) 續頁

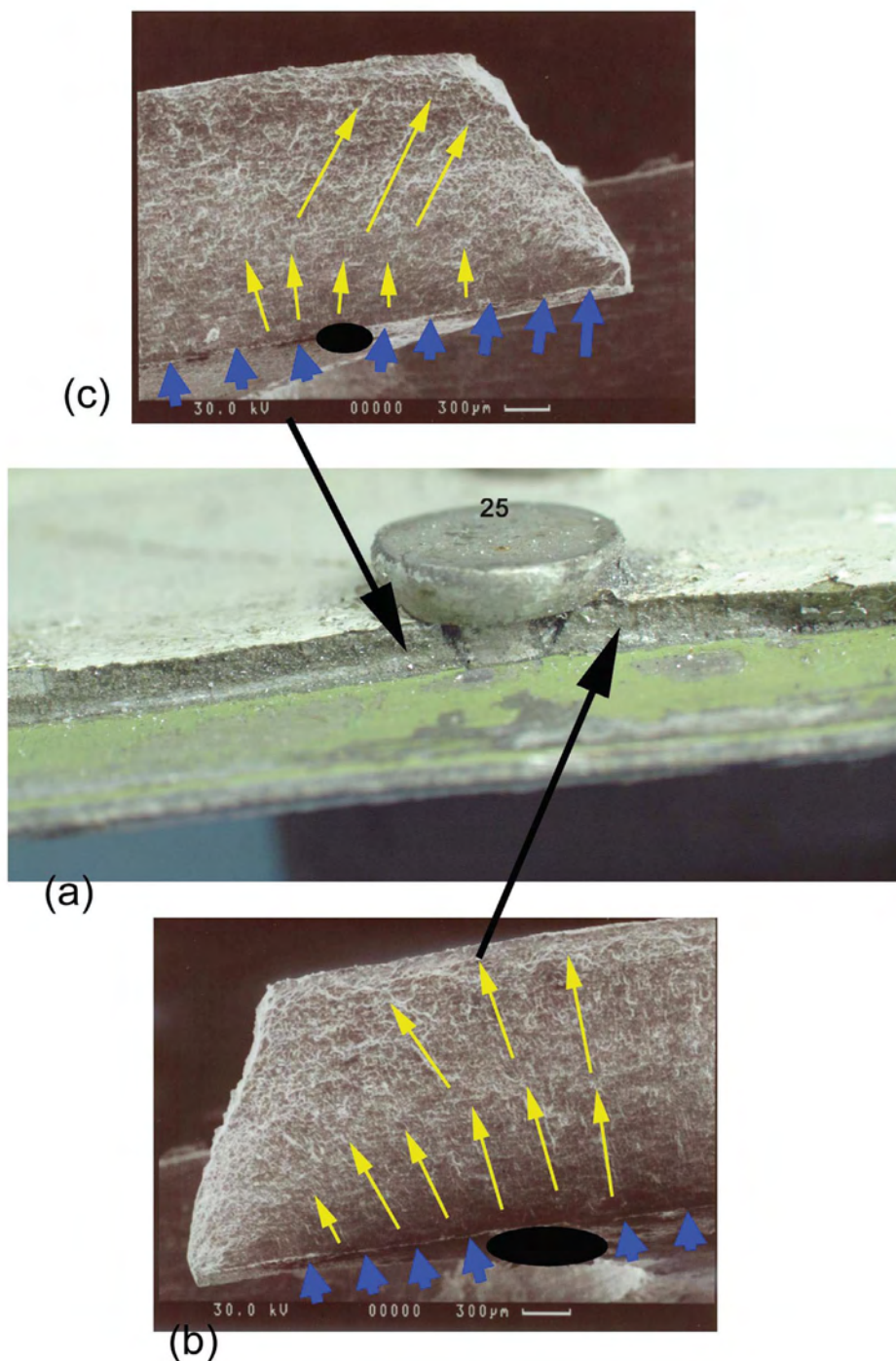

Figure 13

材料試驗報告(Materials Test Report) 續頁

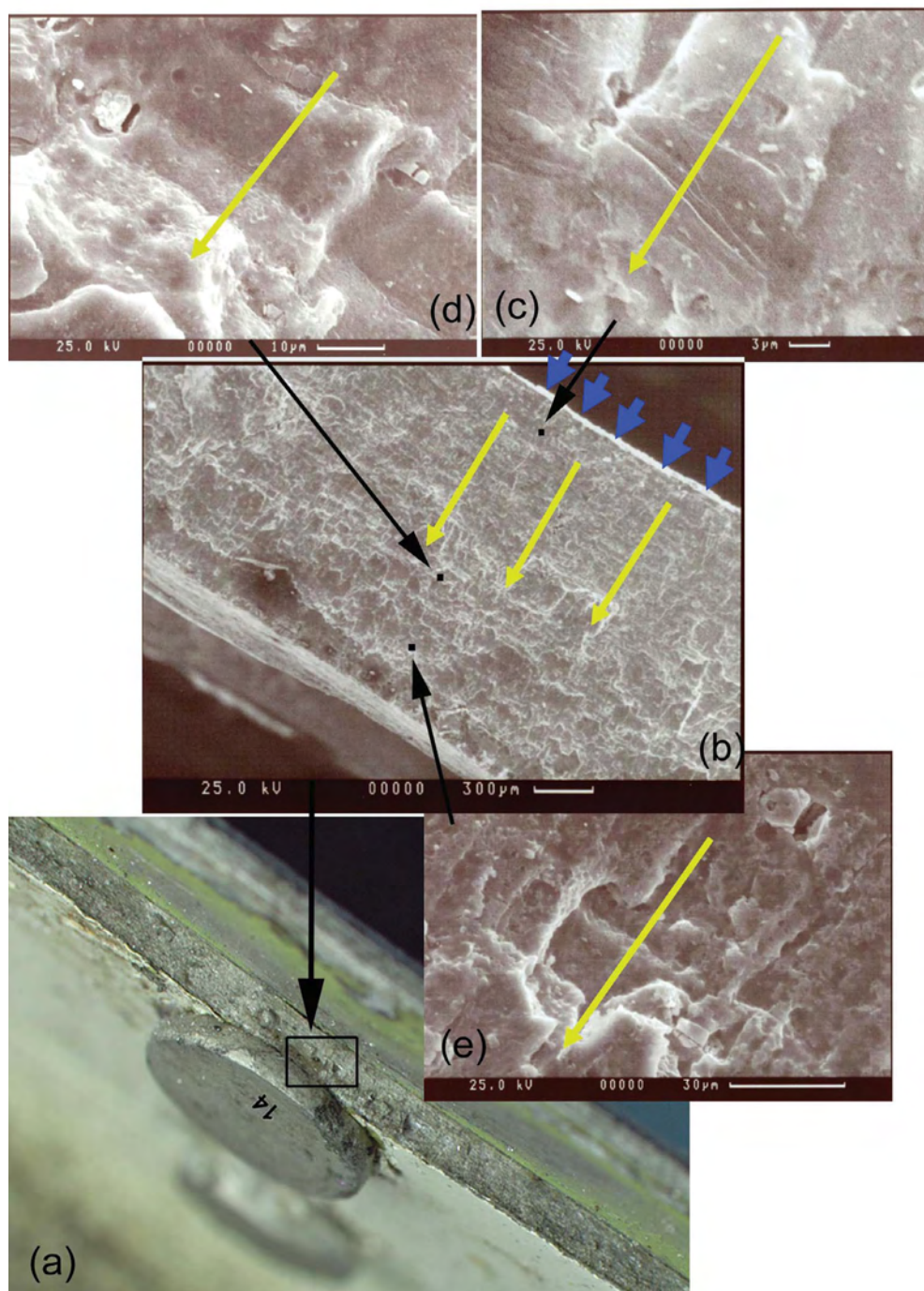

Figure 14

⊕ 材料試驗報告 (Materials Test Report) 續頁

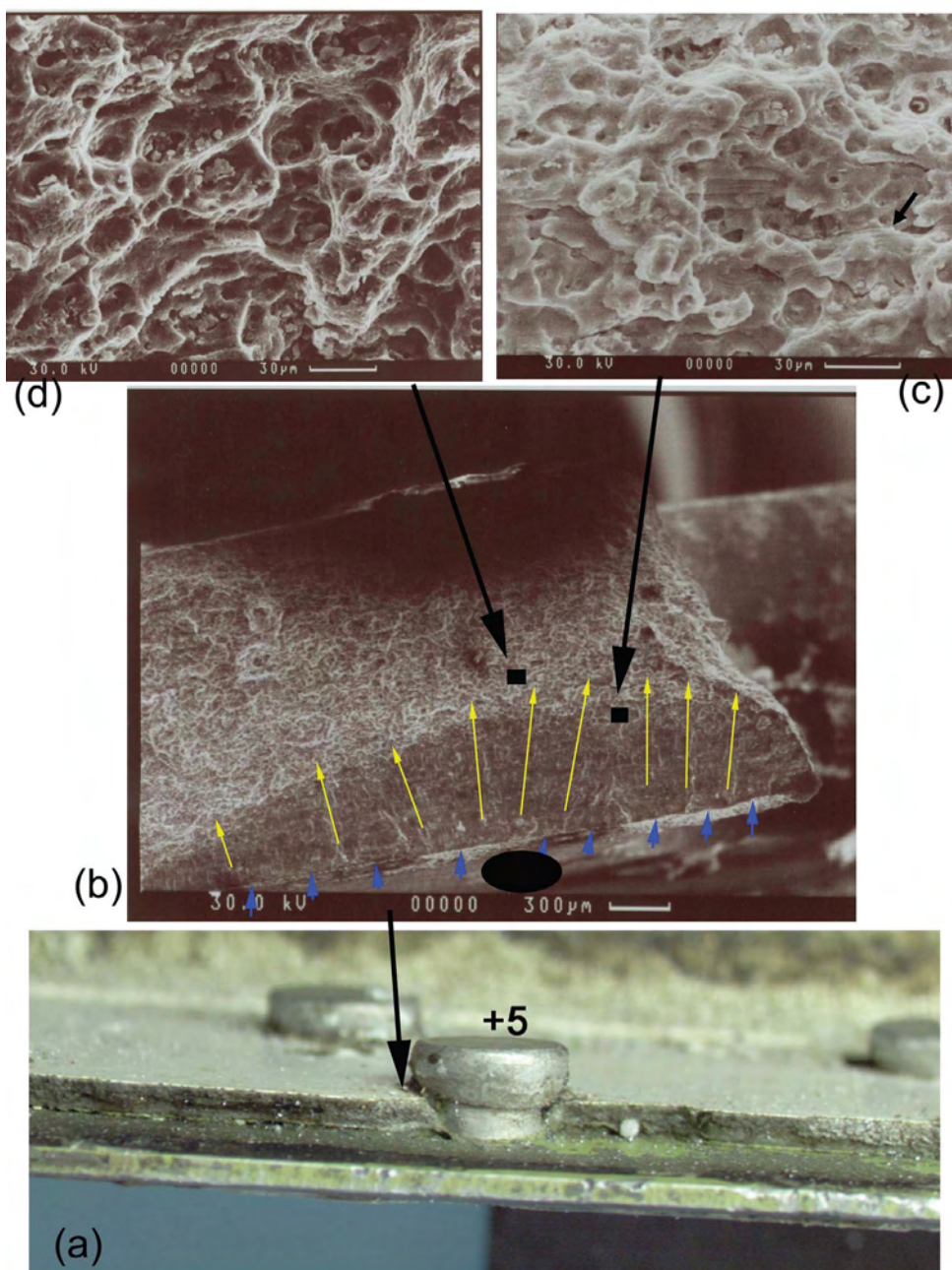

Figure 15

⊕ 材料試驗報告 (Materials Test Report) 續頁

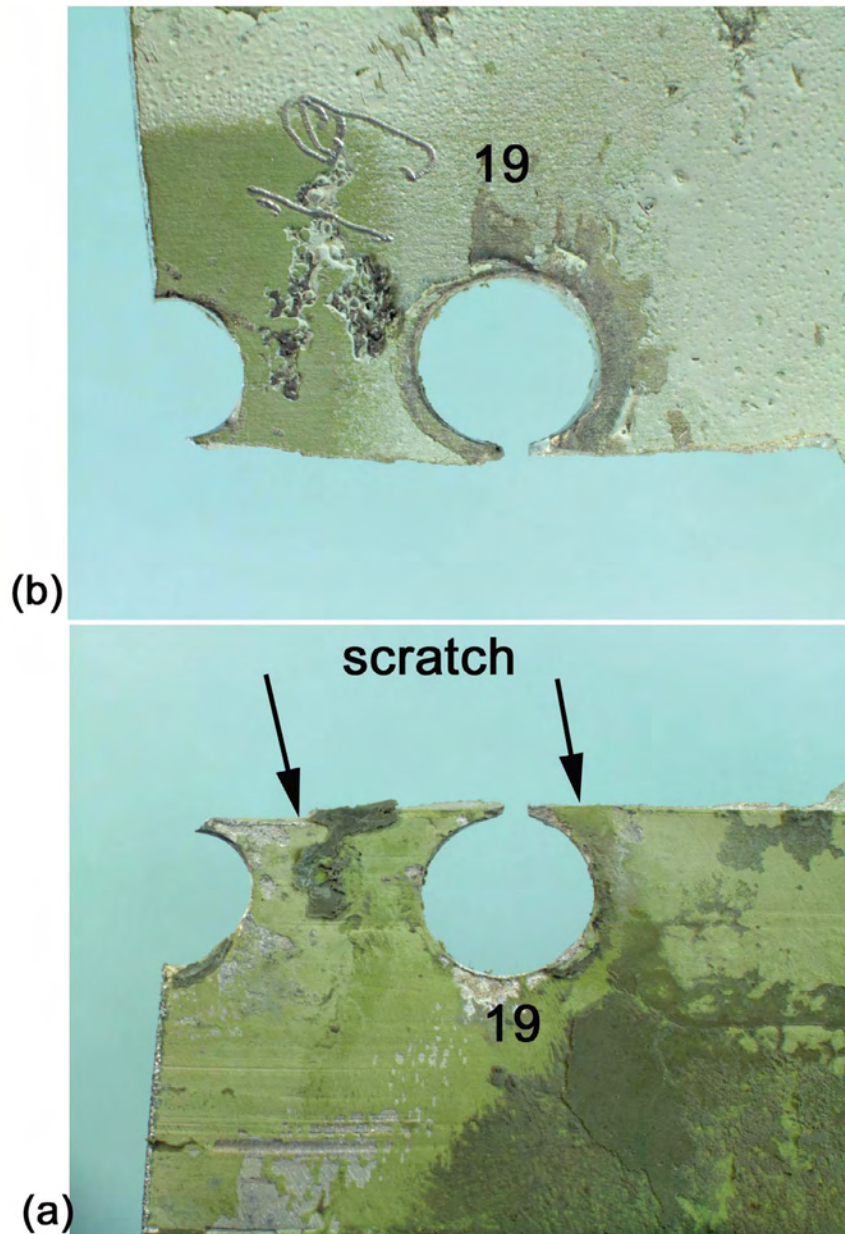

Figure 16

材料試驗報告(Materials Test Report) 續頁

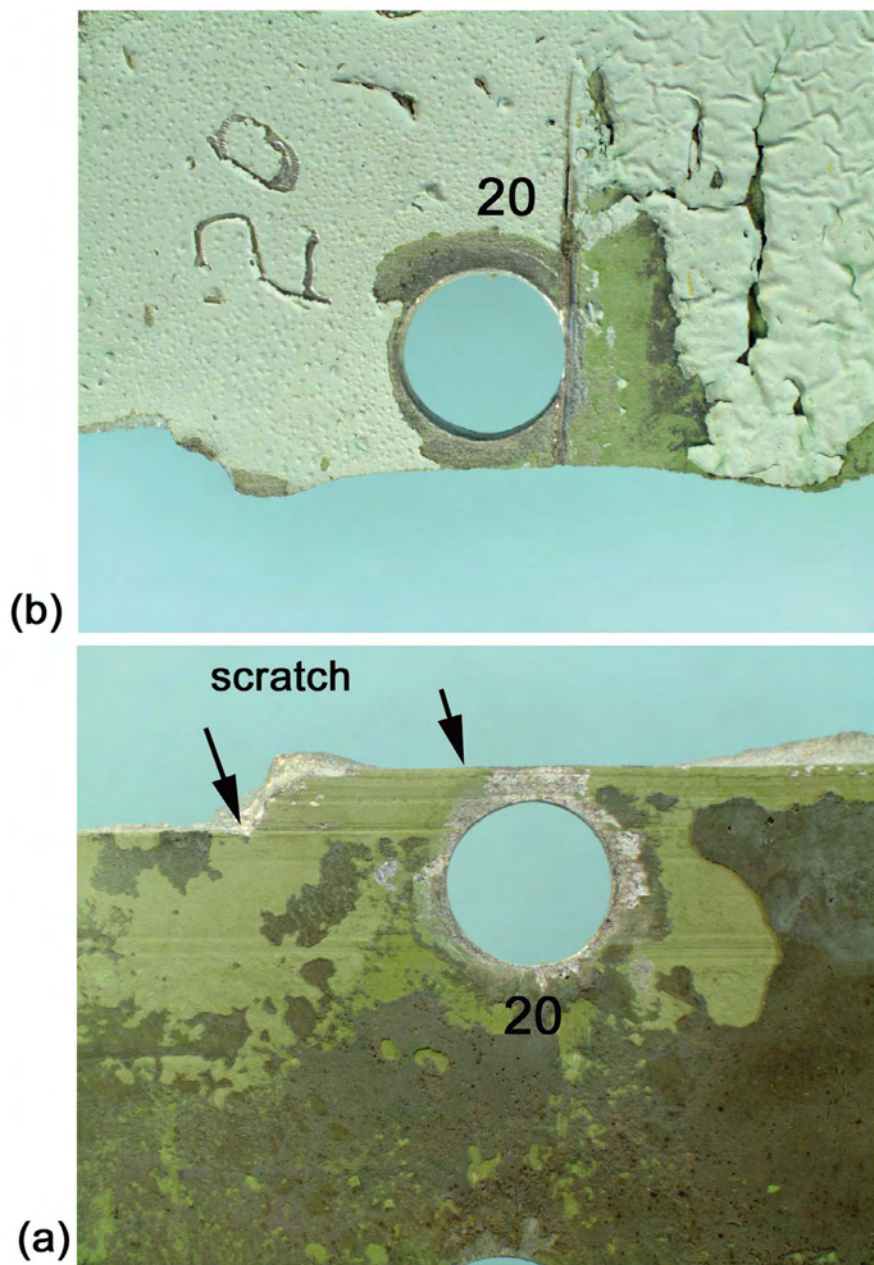

Figure 17

材料試驗報告(Materials Test Report) 續頁

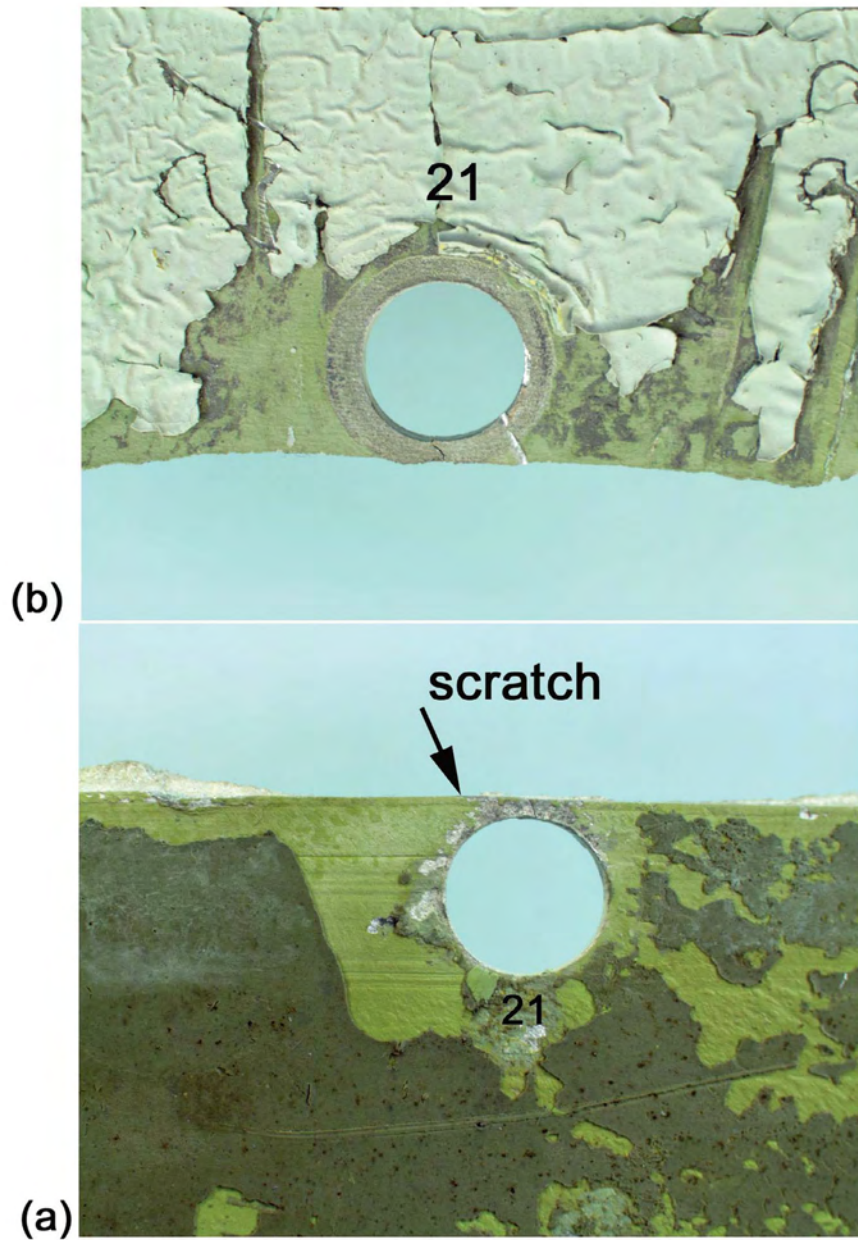

Figure 18

材料試驗報告 (Materials Test Report) 續頁

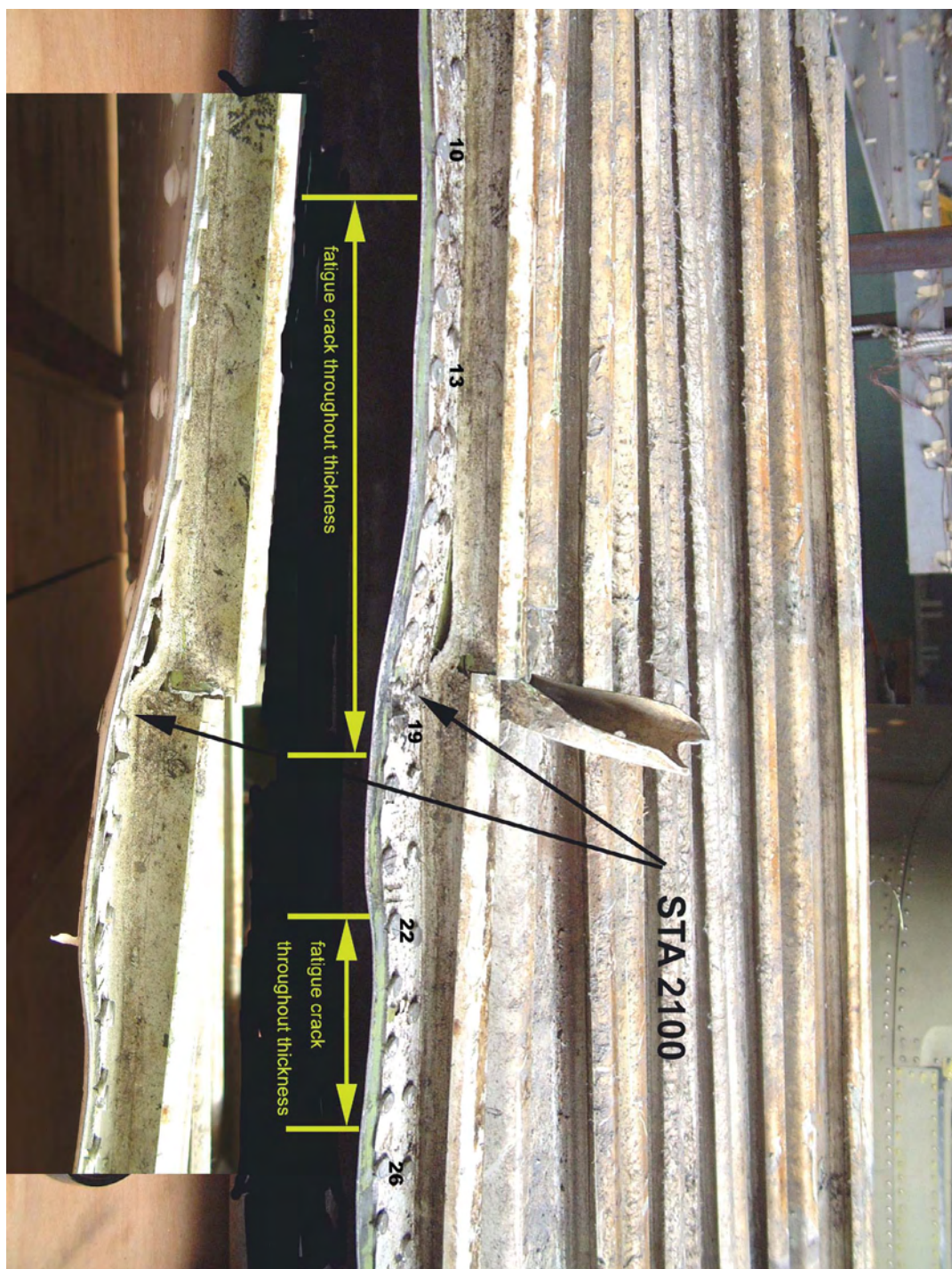
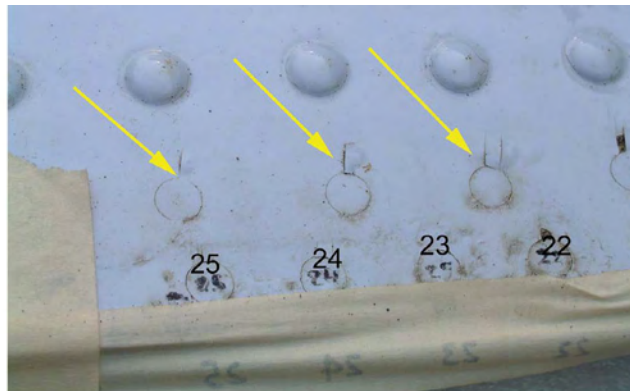
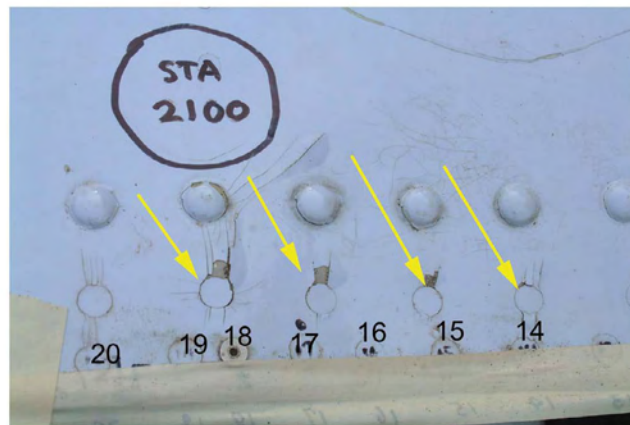

Figure 19

材料試驗報告(Materials Test Report) 續頁



(a)



(b)

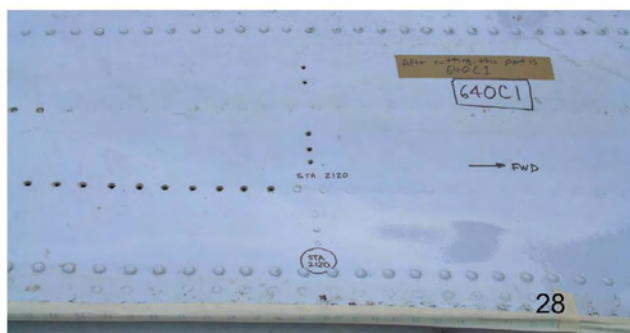

(c)

Figure 20

材料試驗報告(Materials Test Report) 續頁

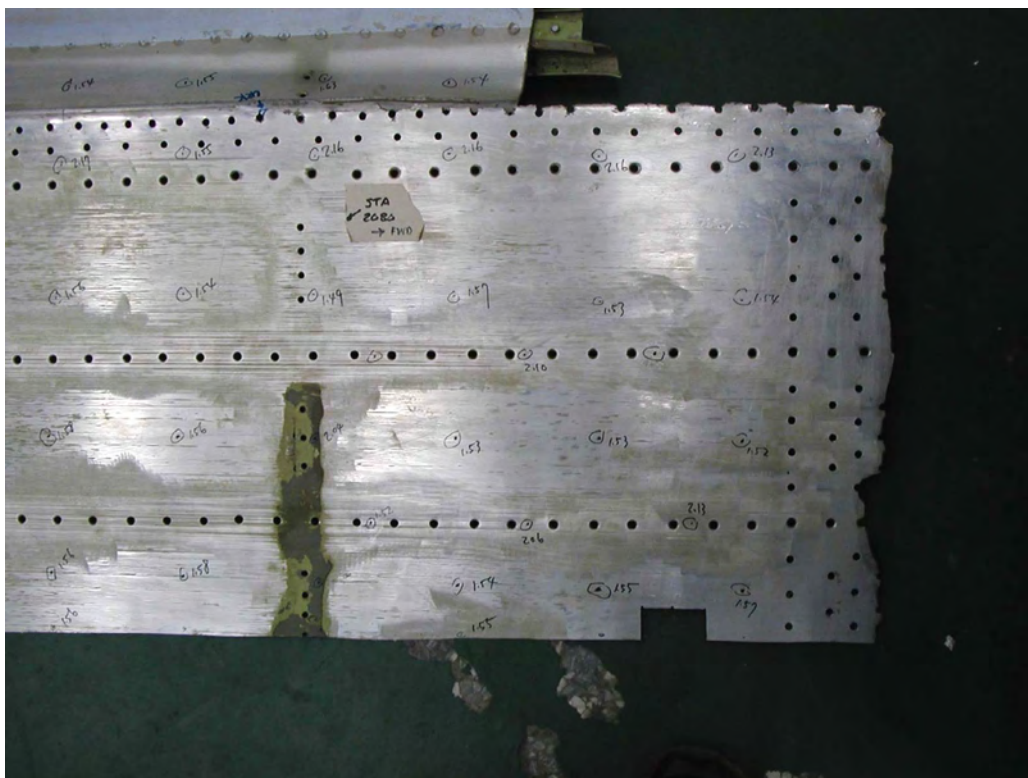

Figure 21

⊕ 材料試驗報告 (Materials Test Report) 續頁

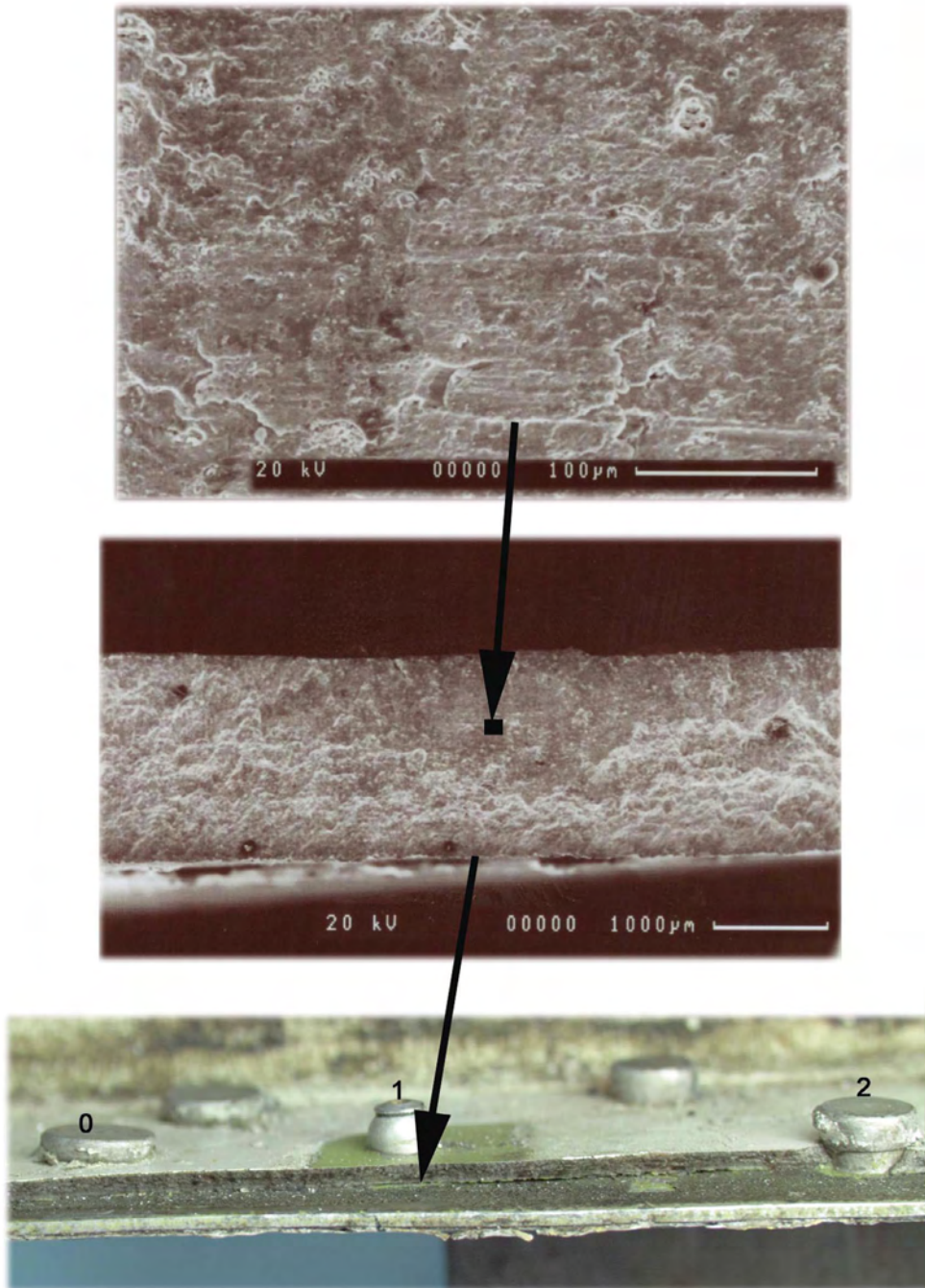

Figure 22

材料試驗報告(Materials Test Report) 續頁

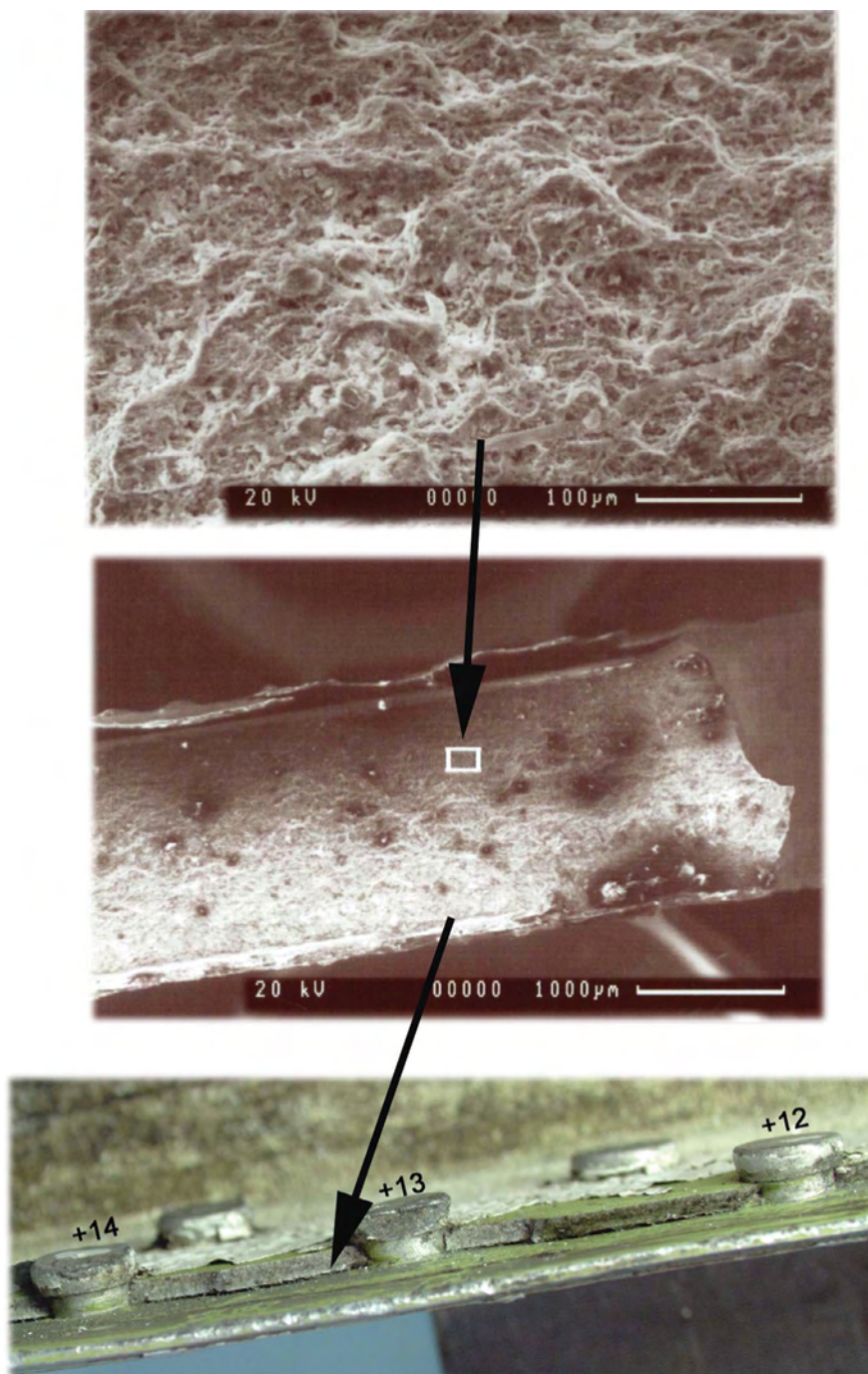

Figure 23

此頁空白

附錄 16 波音 BMT 實驗室測試報告

BMT BOEING MATERIALS TECHNOLOGY

Engineering Report No: MS 22570

Date: December 18, 2002

Design Drawing Part Names: See Table I

Part Numbers: See Table I

ATA Index: 5380

Responsible Design Group: Fuselage

Customer: China Airlines

Model: 747-200

Registry No.: B-18255

Line Position No.: 386

Flight Hours: 64,394

Number of Landings: 21,180

Materials: See Table I

Material Specifications: See Table I

Heat Treats: See Table I

Finishes: See Table I

REFERENCES:

- 1). Chung Shan Institute of Science and Technology (CSIST) – Aeronautical Research Laboratory – Aero Materials Department, Report 910383 draft, dated October 14, 2002.
- 2). Telexes CI-TPE-80-21TE, CI-TPE-80-22
- 3). D6-13592, 747 Structural Repair Manual, SRM 51-30-02

BACKGROUND:

On May 25, 2002, a 747-200, B-18255, operated by China Airlines as flight CI611, crashed in the Taiwan Strait on a flight from Taipei, Taiwan to Hong Kong, China. The airplane disappeared from radar at approximately 35,000 feet altitude. There were 206 passengers and a crew of 19 on board the airplane and all received fatal injuries. During the recovery phase of the accident investigation, a fuselage skin panel from Body Station 1920 (STA 1920) to Body Station 2181 (STA 2181), Stringer 23 right (S-23R) to Stringer 49 left (S-49L) was recovered at Latitude - 23 degrees, 58 minutes, 51.702 seconds, Longitude – 119 degrees, 42 minutes, 43.722 seconds on June 30, 2002. This skin panel was given the identification of item 640 by the Aviation Safety Council (ASC) of Taiwan (See Figure 1). Field examination of this item revealed a number of areas exhibiting slow crack growth features (e.g. fatigue) along the fracture above S-49L. Two sections (item 640C1 and C2 – see Figure 2) of this skin panel containing the fracture above S-49L were sectioned from the wreckage by the ASC and submitted to the Chung Shan Institute of Science and Technology (CSIST) for metallurgical examination. Representatives from Boeing Materials Technology (BMT) participated in the examination of the subject skin panel at the CSIST during the period of July 31, 2002 to September 6, 2002. An English translation (Ref. 1) of the draft CSIST factual report was issued on October 14, 2002.

Subsequent to completion of this work, trawling efforts were undertaken to recover more wreckage. Upon completion of this activity, the ASC requested that the subject fuselage skin panel examined by the CSIST along with all recovered frame segments common to and in the vicinity of the subject skin panel be submitted to BMT for metallurgical examination. Table I provides a description of all the wreckage items

submitted by the ASC for examination. The ASC requested that BMT perform 1) verification of the work conducted by the CSIST on the item 640C1 and C2 skin panel, 2) more extensive determination of crack propagation characteristics of the fatigue cracks present on item 640C1 and 3) examination of all frame segments recovered to date that were common to and in the vicinity of the item 640C1 and C2 skin panel. Representatives from the ASC, NTSB, FAA, CSIST, and China Airlines participated in this examination at the BMT laboratory starting November 6, 2002.

RESULTS:

EXAMINATION CONDUCTED AT CHUNG SHAN INSTITUTE OF SCIENCE AND TECHNOLOGY (CSIST):

The following information was collected at the CSIST laboratories in Taichung, Taiwan during the period of July 31, 2002 to September 6, 2002 in the presence of BMT personnel and is presented in this report for formal documentation purposes.

External and Internal Condition of item 640C1 and C2:

Field notes were taken in Makung, Taiwan on item 640C1 and C2 fuselage skin panel sections to document the condition of the items prior to shipment to the CSIST. Figure 2 provides a view of item 640 with the locations of 640C1 and C2 prior to removal in Makung. Figure 3 provides a view of the interior surface of item 640C1 prior to disassembly at the CSIST laboratory. Item 640C1 contained a 23 inch wide external repair doubler (from here on referred to as the doubler) from approximately STA 2060 to STA 2180 which was installed after a tail strike event was experienced upon landing as reported in reference 2). The doubler terminated between S-48L and S-49L on one side and between S-50R and S-51R on the other side. The doubler was attached to the skin by two rows of countersunk rivets around its periphery as well as by fasteners common to the stringer and shear tie locations. Universal head rivets were used at S-51R and S-49L while countersunk rivets were used at S-50L and S-51L. Stringer splice repairs were present forward and aft of STA 2160 at S-51R and S-49L. Each of the four splice repairs measured approximately 11 inches in length. At STA 2160 a partial portion of the frame containing three shear ties, the failsafe chord, a fragment of the web, and two stringer clips remained attached to the item 640C1 skin panel. No other frames were attached to either item 640C1 or C2 when the parts arrived in Taichung. However, photographs taken aboard the recovery vessel show that a portion of the STA 2100 frame (item 2015) was attached to item 640C1 when it was recovered. A portion of S-50L between STA 2120 and STA 2140 was missing from item 640C1. Detailed notes were taken prior to disassembly noting the condition of the shear tie and stringer clip attachment to the items 640C1 and C2 skin panels. Table II contains the results of this examination.

Doubler Rivet Spacing and Dimensions:

The spacing of the rivets for the two rows used to attach the doubler to the skin above S-49L was measured from the forward edge of the doubler. Figure 4 provides general information on the spacing of these rows in relationship to S-49L and the edge of the doubler. The driven rivet button diameter and thickness of the two rows of rivets used to attach the doubler above S-49L and S-51R were collected as well. Table III and IV contain the rivet spacing, driven rivet button diameter, and driven rivet button thickness data for the two rows above S-49L. Table V contains the driven rivet button diameter and thickness data for the two rows above S-51R. The numbering convention assigned to the rivets was established to provide a correlation to the field notes on this item. Reference to the body station location at particular rivet locations is provided for easier identification. All rivets installed in the two rows above S-49L and S-51R were ¼ inch diameter with the exception of a few blind rivets and smaller diameter solid rivets at certain shear tie locations (see Tables III, IV, and V for details). Figure 3 of SRM 51-30-02 (ref. 3), "Dimensions for Driving Non-Fluid-Tight Solid Shank Rivet" provides requirements for the minimum driven rivet button diameter and minimum driven rivet button thickness for installed rivets. For ¼ inch diameter rivets, the limits are 0.325 inch and 0.100 inch, respectively. The majority of rivets in the two rows above S-49L and S-51R did not satisfy these SRM requirements (see Tables III, IV, and V for details).

EXAMINATION CONDUCTED AT BOEING:

The following information documents the results of the examination conducted at Boeing in the presence of representatives from the ASC, NTSB, FAA, CSIST, and China Airlines during the period of November 6 to 22, 2002.

Examination of Fracture Surfaces above S-49L

The fracture surface common to the second row of rivets above S-49L between holes +17 and 93 were examined with a combination of visual, low power optical (up to 30X magnification), high power optical (up to 1000X), and Scanning Electron Microscopic (SEM) methods. This examination confirmed fatigue cracks at all the locations reported by CSIST and identified three more fatigue cracks at holes +11 aft, 33 aft, and 34 aft. Figures 5 and 6 provide a detailed map of all fatigue cracks confirmed during examination at Boeing. This figure incorporates the rivet spacing recorded in Table III and IV as well. The length of the main fatigue crack centered about STA 2100 was 15.1 inches. Table VI provides the detailed crack lengths of all the fatigue cracks presented in Figures 5 and 6. The cumulative length of fatigue cracking was 25.4 inches. Low power optical examination was also performed to determine the origin of the fatigue cracks. This examination determined that all of the fatigue cracks initiated from longitudinal scratches on the faying surface of the skin with the doubler (original exterior surface of skin) from multiple origins except for the following cracks: +14 aft, +12 aft, + 11 aft, +5 fwd, 33 fwd, 37 aft, 38 fwd, 38 aft, 39 aft, 41 fwd, 42 fwd, 43 aft, 49 aft, and 51 aft. The propagation direction of all fatigue cracks was through the thickness of the skin. The extent of through-thickness propagation and origin location of the fatigue cracks is provided in Table VI. Figures 7 and 8 provide views of some of the scratches present on the faying surface of the skin to the doubler in relationship to the fatigue cracks. During examination a number of secondary fatigue cracks were also observed initiating from the longitudinal scratches.

From Hole 4 to Hole 26 the fracture surface generally maintained a flat profile through the skin thickness, with the exception of an intermediate segment between Holes 6 and 10 where the fracture assumed a slanted profile. The forward and aft end of the flat profile fatigue fracture surfaces displayed transition zones where the cracking mechanism changed from plane strain to plane stress conditions. Large transition zones were associated with the forward and aft extension of the main fatigue cracking between holes 10 and 25, as well as the forward extension of the fatigue cracking between holes 4 and 6 (see Figures 9 through 11). Generally, the smaller flat profile fatigue regions forward of hole 3 and aft of hole 32 displayed relatively brief transition zones. Figures 12 through 14 demonstrate the very small transition zones at holes +3 and 39.

Beyond the flat profile and transition zones of the main fatigue areas, the fracture surface contained numerous segments that displayed indications of incremental crack growth (referred to as quasi-stable crack growth in this report) that could be observed visually or with the aid of low power optical instrumentation (Figures 15 and 16). In general, these indications were observed to increase in spacing as the distance from the flat profile fatigue regions increased in both the forward and aft directions. Such features were also observed on the fracture face between holes 6 and 10 with increasing spacing in the forward direction (Figure 17). Incremental crack growth indications were observed as far forward as approximately STA 2055 and as far aft as hole 56 (STA 2140).

Cyclic rubbing of the fracture surface and associated compression deformation of the cladding was observed along the faying surface providing additional evidence of cracking that occurred prior to the accident flight. Figure 18 shows the visible appearance of the fracture surface near holes 57, 58, and 59. The damage that produced the scratches on the faying surface removed significant amounts of cladding. However, all areas where cladding remained forward and aft of the main fatigue cracking displayed compressive deformation due to crack closure as far forward as hole +17 and as far aft as hole 62. Figures 19 through 21 are SEM photographs showing the appearance of such aluminum cladding deformation. The remaining fracture aft of hole 62 displayed "necking", which is typical of continuous tensile loading to ultimate tensile separation (Figure 22). These observations suggest that cracking in the skin was continuous from approximately STA 2055 to 2146, or approximately 93 inches prior to the accident flight.

Striation Counts

Although much of the fracture suffered from heavy corrosion, fatigue striations were resolved by SEM in many local areas of the fatigue cracking regions as described in Figures 5 and 6. Striation counting was performed at a number of locations along the flat profile fatigue regions of the fracture. Since the fracture surface was not continuous from a single fatigue initiation origin to the ultimate extent of stage II (striation producing) cracking, it was not possible to estimate a time of initiation. Instead, the nature of cracking on this detail provided numerous initiation sites along scratches on the faying surface, with subsequent propagation in the through-thickness direction. Because cyclic cabin pressure is the prevailing driving force for cracking at this detail, each striation is considered to represent the microscopic crack advancement during one flight cycle of the airplane. Thus, striation counting was performed in order to obtain an estimate of the number of flight cycles that contributed to the fatigue crack propagation through the material thickness. Reference 1 reported the observation of “major” and “minor” striations. The occurrence of striation-like features appearing between actual striations is not uncommon for fatigue cracks in similar structural details propagating at mature growth rates. These minor striation-like features are shown in Figure 23 and were ignored for striation counting purposes.

Fatigue cycle estimates were obtained at the locations on the fracture listed in Table VII along with the calculated results. For each location, a traverse across the fracture at several points between the skin surfaces was made by sampling striation spacing with SEM photographs (Figure 24). For determining the crack length at each sample point, x and y Cartesian coordinates generated by the SEM stage were recorded and compared with a reference slope using an analytical geometrical approach. Striation spacing was determined by direct measurement from a photograph at each sampling location. The data was reduced and calculated by employing a trapezoidal integration method, whereby the number of cycles between two successive data points is equal to the distance divided by the average striation spacing (half of the sum of the growth rates at the two points). Although this approach may not precisely represent actual cracking behavior, it removes some of the subjectivity of assigning best-fit curves to widely scattered data points and can provide useful information, given an understanding of its limitations.

In each case, there was a distance between the initiation site and the nearest location where striations could be resolved. On the other end of each traverse, there was a distance between the inner surface of the skin, labeled “end of cracking” (EOC) for striation counting purposes, and the point where striations were observed. Hence, growth rates in those regions could not be determined. Since these distances were sometimes a significant portion of the actual crack propagation, the results are reported in two columns in Table VII. One column, “Total Cycles (Point)”, shows the estimated number of striations (or flight cycles) between the first and last obtainable data point. Another column, “Total Cycles (Ext.)”, includes that, as well as the unknown regions. This information is extrapolated by assuming constant growth rate from the initiation site to, and equal to, the first obtainable data point. Again, such extrapolation may not accurately represent actual fatigue cracking behavior, but it is presented here for discussion purposes to account for an estimate of flight cycles that may have contributed to the cracking up to that point and may be considered a minimum. The raw data collected, as well as the integrated calculations are provided in the attached Appendix I.

Examination of Skin

Photographs showing features of the as-received item 640 C1 skin inboard and outboard (repair faying surface) surfaces are shown in Figures 25 and 26 respectively. Protective finishes had previously been removed from much of the repair faying surface at the CSIST to enable examination of skin damage consistent with a tail strike event. Close-up photographs displaying the extent of damage consistent with a tail strike are shown in Figures 27 through 36. This damage consists primarily of fore to aft (longitudinal) scratching with the most severe scratching typically occurring at the location of skin stiffening members such as skin stringers and body frame shear ties. Figure 37 displays the location of the most severe skin damage. As noted in this photograph, the most severe damage consistent with a tail strike occurred on the left hand side of the airplane in the area covered by the repair doubler. Evidence of an attempt to blend out these skin scratches, in the form of rework sanding marks, was noted over much of the repair surface.

A surface replication medium was applied at five locations on the skin repair faying surface as shown in Figure 38 to examine scratch geometry and depth. The locations were chosen to display surface features typical to areas exhibiting major scratching. This medium creates a “positive” of the surface it is applied to, enabling direct feature measurement from the replica. The maximum scratch depth measured with this technique was 0.0096 inch. Composite photographs exhibiting scratch profiles at locations noted above are shown in Figures 39 and 40.

The thickness of the skin was measured ultrasonically at several locations. Thickness measurements were recorded in millimeters directly on the skin at point of measurement and are documented in Figures 41 through 46. The ultrasonic unit was calibrated using a reference sample and ultrasonic measurements were also verified using a calibrated micrometer. Ultrasonic skin thickness measurement was a duplication of work previously done at the CSIST, however the CSIST measurements were consistently lower than measurements performed at Boeing. The reason for this discrepancy is unknown, but may have been due to an instrument calibration error.

Corrosion was noted at several shear tie locations on the skin inboard surface sometimes penetrating completely through the skin thickness. General features of this damage and the general condition of the skin indicate that the corrosion most probably existed at the time of the accident, and was not a result of salt water immersion after the event. Photographs displaying these corrosion features are shown in Figures 47 through 49. Table VIII records visual observations of these features.

Open hole High Frequency Eddy Current (HFEC) inspection of the skin was performed on the outer two rows of fastener holes associated with attachment of the repair doubler above S- 51R. A total of ten crack indications were identified, nine occurred in the second fastener row above S-51R and one occurred in the first fastener row above S-51R. Open hole HFEC inspection of the second row of fastener holes above S-51R had previously been performed by a China Airlines inspector with three holes indicating cracking. The skin/doubler sealant fillet region was inspected by HFEC using a surface probe. Visual examination of this area previously identified longitudinal scratches in the skin in this region that were different in appearance and severity (less severe) relative to probable tail strike scratches. These scratches may have been the result of rework of the sealant fillet. No evidence of cracking was identified in this region. This result was consistent with HFEC surface probe testing previously done at the CSIST.

“Cookie cuts” were excised from the skin at HFEC crack indications to enable further examination. Figures 50 through 53 document the location of cookie cut samples. Cookie cuts 1 and 4 were inadvertently damaged during removal, destroying all fastener bore features. The remaining excised samples were penetrant inspected and optically examined to 50X. Cracking was visually identified on three of the remaining cookie cuts (#3, #7 and #9). Cracks in cookie cuts #3 and #9 were successfully opened, while #7 proved too small to open. Crack features were examined from low to high magnification in a Scanning Electron Microscope (SEM). Figures 54 through 57 display the crack features. Cracking in cookie cut #3 was due to fatigue originating from multiple origins at the skin faying surface, away from the fastener bore (Figure 54). The crack length was 0.028 inch and maximum crack penetration through the skin thickness was 0.011 inch. Cracking in cookie cut #9 was also due to fatigue but initiated from the fastener bore from an origin near the bore/skin repair faying surface interface (Figure 56). The crack length and its propagation through the skin thickness were both 0.044 inch. Fatigue features seen in both cracks were indicative of fuselage pressure cycles (Figures 55 and 57).

A metallographic specimen was removed from plane A-A (Figure 51) to examine scratch features associated with sealant fillet seal scratching. A composite photograph of this section is shown in Figure 58. Maximum scratch depth was measured at 0.0037 inch. Plane AA also traversed the only area of probable tail strike damage associated with the right hand side of the repair. The damage at this location was much less severe than the skin damage on the left hand side of the repair. Figure 59 displays surface features associated with the outer fastener row of the repair. A maximum scratch depth of 0.0008 was measured optically in this location.

Full size longitudinal (L) and long transverse (LT) tensile specimens were excised from the skin in the vicinity of STA 2080, between stringers S-48R and S-50R. The specimens were tested to destruction and tensile test results are recorded in Table IX. All values met minimum property requirements per QQ-A-

250/5 for clad 2024-T3 sheet as specified by the engineering drawing. Specimen geometry and test procedures were per ASTM B557.

Remnants of two ¼ inch diameter countersunk doubler repair rivets previously removed and labeled at the CSIST were selected at random to determine their alloy and temper. These rivets were identified as E64 and D51, however their location relative to installation in the repair was not provided. Spectrochemical analysis verified the rivet alloy was 2017 per QQ-A-430 aluminum as recorded in Table XI. Hardness and conductivity measurements were indicative of the T4XXX temper as noted in Table XII.

The thickness of the fuselage skin was measured along the fracture above S-49L at intervals of 0.10 inch from hole +17 to 56 using a calibrated point contact micrometer. The drawing required thickness at this location is 0.071 inch with a tolerance of + 0.010 inch, – 0.004 inch. The measured skin thickness ranged from 0.062 inch at hole 19 to 0.078 inch between hole 24 and 25. A number of localized areas with below drawing allowed thickness were measured and were most likely due to the presence of a scratch or localized rework. This thickness data was plotted along the length of the crack from hole +17 to 56 (see Figure 60 for details).

Metallographic specimens were taken through the main fatigue region to characterize the depth and geometry of the longitudinal scratches initiating the through-thickness fatigue cracks. The cross sections were taken in the vicinity of STA 2100 between holes 18 and 19 and between holes 19 and 20. Figure 61 provides the location of the cross section taken between holes 18 and 19. At this location two longitudinal scratches were visible with one being the initiation site for the primary fatigue crack forward of hole 19 and another scratch being the site for initiation of the primary fatigue crack aft of hole 18. A secondary fatigue crack under that primary fatigue crack aft of hole 18 was also present. Evidence of rework blending (sanding) was present in the vicinity of the scratches. To accurately determine the depth of these scratches a line was projected back to an area of undisturbed clad material. At this location the depth of the scratches measured from 0.0043 inch (110 microns) to 0.0046 inch (118 microns) (see Figure 62). The cross section taken between hole 19 and 20 represented an area with a number of scratches where the primary fatigue crack aft of hole 20 and secondary fatigue crack initiated. Figure 63 provides the location where the cross section was taken. Rework sanding was also present at this location and therefore a similar projection technique was employed to accurately determine the depth of the scratches in this area. The depth of scratches ranged from 0.0056 inch (143 microns) at the primary fatigue crack to 0.0025 inch (63 microns) at the secondary fatigue crack origin (see Figure 64)

Examination of Repair Doubler:

Visual examination revealed a light colored deposit on the overhanging portion of the faying surface of the doubler (mating surface with skin) above the fracture surface at S-49L. Low power optical examination of this area revealed that this light colored deposit had a similar appearance to the light blue exterior paint applied to the doubler. This light colored deposit was on top of what appeared to be the sealant used during installation of the doubler to the skin. The deposit was present between holes 10 and 25 with the largest area observed between holes 14 and 22 (see Figures 65 and 66). Two samples of this deposit were removed in the vicinity of hole 18 (STA 2100) and subjected to organic analysis utilizing Fourier Transform Infrared Spectroscopy (FT-IR). A sample of the exterior paint on the doubler was also removed as well as the sealant on the faying surface for baseline comparisons. FT-IR analysis of the deposit revealed that the spectra of the light colored deposit was an excellent match to the reference light blue exterior paint on the doubler (see Figure 67). Optical examination of the deposits showed that the paint had cured in place and therefore must have flowed between the doubler and skin while wet. As noted in the CSIST report the doubler in the vicinity STA 2100 was deformed locally in an outward direction with the fractured skin. This observation, along with the confirmation of paint on the doubler faying surface at STA 2100, would suggest that the doubler was displaced from the unrecovered portion of the skin during the last repaint of the airplane. As was previously noted, the main fatigue crack was centered about STA 2100 from hole 10 to 25.

Numerous areas of the overhanging portion of the faying surface of the doubler exhibited signs of localized fretting above the S-49L fracture surface. The fretting damage was observed from hole +16

(~STA 2061) to hole 49 (~STA 2132) with the most significant degree present between holes 8 and 43. Low power optical examination determined the fretting damage resulted from hoop-wise movement. The degree and position of this hoop wise fretting is documented in Table X with photographic examples provided in Figure 68 and 69. The source of this fretting damage was not conclusively determined but based on its location with respect to fatigue cracking and further progression of the crack in a quasi-stable manner, it most likely is the result of repeated crack opening during crack propagation prior to the accident flight.

Examination of Frame Segments:

All the recovered frame segments in the vicinity of the item 640C1 and C2 skin panel were submitted to BMT for: 1) examination of all the fracture surfaces to determine fracture modes, evidence of pre-existing damage, and fracture propagation direction; 2) examination of all shear ties for evidence of separation direction from the skin panel; 3) material and temper verification of critical frame members (failsafe chord, inner chord, and shear ties). A total of five frame segments from STA 2160, 2100, 2060, 2040, and 1940 were received for examination (see Table I for details). The following provides the results of this examination on each of these frame segments:

STA 2160 Frame Segment Between S-51L to S-48L:

This frame segment was part of the recovered item 640C1 skin panel and was removed during disassembly at the CSIST laboratory (see Figure 70). The overall condition of the submitted frame segment as received by BMT is shown in Figures 71 and 72. The frame segment contained three shear ties, the failsafe chord, a portion of a stringer clip and a portion of the web. A repair existed at the shear tie between S-51L and S-50L. The repaired shear tie exhibited no corrosion, however, the mating interior surface of the fuselage skin as previously described in Figure 49 displayed two pockets of exfoliation corrosion with corresponding cracks visible on the exterior surface of the original skin (faying surface with repair doubler). A significant lump of sealant was found attached to the aft side of the shear tie free flange and skin flange. An impression of the skin corrosion was evident in the surface of the sealant faying with the interior surface of the skin. The shear tie between S-50L and S-49L was heavily corroded with no remaining skin flange attachment provided for examination. The associated mating interior surface of the fuselage skin displayed no evidence of corrosion. The shear tie between S-49L and S-48L was heavily corroded with no remaining skin flange attachment. The skin at this location was free of corrosion on the interior surface mating with the shear tie skin flange, however this represents only a small portion of the mating interior surface. The rest of associated mating interior surface has not been recovered to date.

Visual and low power optical examination of the failsafe chord fractures at both forward and aft ends of this frame segment revealed slanted fracture profiles with fracture morphologies consistent with ductile separation. No evidence of any pre-existing damage (i.e. slow crack growth or corrosion) was present. A considerable degree of post fracture mechanical damage (i.e. rub) was observed at the failsafe chord fracture common to S-48L. Closer examination of the two shear ties between S-50L and S-48L revealed a considerable degree of pre-existing exfoliation corrosion primarily at the mid thickness plane of the shear tie (see Figures 73 and 74). Low power optical examination of these fracture surfaces revealed further fragmentation by exfoliation corrosion or slanted type fractures with no evidence of any slow crack growth.

The one shear tie with the skin flange still intact on the submitted frame segment (between S-51L and S-50L) exhibited a compressed free flange and rivets pushed in the upward direction. The skin flange rivets were fractured at the countersink head by what appeared to be straight tension type load. Prior to disassembly of this frame segment from the Item 640C1 skin panel, notes were taken at the CSIST laboratory (see Table II) indicating that this shear tie was still attached to the skin but that the rivets were completely pulled through the doubler but remained in the skin. This shear tie was also reported to exhibit up and aftward deformation.

Spectrochemical analysis confirmed the failsafe chord was fabricated from 7075 aluminum alloy in accordance with the drawing requirements (see Table XI). Hardness and conductivity measurements verified the drawing required T6 type temper (see Table XII for details). The same techniques determined

that the material for the shear tie repair was 2024 aluminum alloy in the T4 type temper. The drawing required thickness, material, and temper for this shear tie is 0.063 inch thick 7075-T62 aluminum alloy. The thickness of this repair shear tie was measured by use of a micrometer to be 0.071 inch.

STA 2100 Frame Segment Between S-49L to S-48R (Item 2015):

The overall condition of this frame segment as received by BMT is presented in Figures 75 and 76.

The fracture to the S-49L end of this frame segment was common to the failsafe chord, shear tie, web and intermediate chord. Visual and low power optical examination of these fracture surfaces revealed slanted fracture profiles with fracture morphologies consistent with ductile separation. No evidence of pre-existing damage (slow crack growth or corrosion) was observed. The fractured end common to S-49L exhibited deformation of the shear tie member in the forward direction and deformation of the web at the intermediate chord location in the aft direction (refer to Figure 77). In addition, the hole in the shear tie at the fracture location was elongated in the upward direction. No evidence of compressed or buckled members at this area was noted.

Examination of the remaining fracture surfaces for the failsafe chord, shear ties, inner chord, and stringer clips by visual and low power optical techniques revealed slanted fracture profiles with fracture morphologies consistent with ductile separation. No evidence of any pre-existing slow crack growth or corrosion on these fractures was observed.

The shear ties present on this frame segment were examined for evidence of separation direction from the skin. The shear tie skin flange and skin attachment rivets were examined using visual and low power optical techniques to determine if any evidence of loading direction was present. The shear tie between S-49L and S-50L was fractured in the free flange and therefore no separation direction observations were made or assessment of pre-existing corrosion in the skin flange. As previously noted extensive corrosion existed through the thickness of the skin at this shear tie location. The shear tie between S-50L and S-51L had a small portion of the skin flange at the inboard most fastener hole remaining. The remnants of this fastener hole exhibited deformation in the downward direction indicative of a tensile pull through of the fastener. The shear tie between S-51L and S-51R exhibited deformation at all three fastener holes common to the skin in the downward direction as well. The skin flange of the shear tie between S-51R and S-50R was not fractured but the inboard most fastener hole was deformed in the downward direction with the rivet missing (see Figure 78). The remaining two rivets were fractured at the countersink and exhibited fracture and deformation characteristics that indicated a forward component of this tensile load. Similar results of the fracture and deformation characteristics indicative of a forward acting tensile load were observed in the all three rivets common to the skin flange for the shear tie between S-50R and S-49R. The shear tie between S-49R and S-48R had Hi-Loks installed at the skin flange. The Hi-Loks were not fractured but the holes in the shear tie skin flange containing these fasteners were loose. The holes in the mating skin at this shear tie location were deformed in the upward direction on the aft side of the hole with witness marks on the forward side of the skin (see Figure 79). These observations were consistent with all others for this frame indicating a forward acting tensile load on the shear ties of this frame segment.

Spectrochemical analysis, hardness and conductivity measurements performed on samples of the failsafe chord and inner chord of this frame segment confirmed that the failsafe chord and inner chord were fabricated from the drawing required 7075 aluminum alloy in the T6 type temper. The shear tie sampled was verified using the same methods as 2024 aluminum alloy in the T4 type temper in accordance with the drawing requirements (see Table XI and XII for details).

STA 2060 Frame Segment Between S-49L to S-51R (Item 2014):

The as-received condition of this frame segment is shown in Figures 80 and 81. This frame segment contained three stringer clips, two shear ties, the failsafe chord, the intermediate chord and a portion of the web.

The fracture at S-49L was common with the failsafe chord and web. The shear tie at this location fractured through one fastener hole inboard of this location. Visual examination of the fracture surface of the failsafe chord revealed a slanted fracture profile, however, a heavy, dark deposit in a localized area of the fracture precluded complete examination (see Figure 82). Attempts to remove this deposit using

surfactants and solvents were unsuccessful. The remainder of this fracture surface was examined with the use of low power optical techniques to reveal a fracture morphology characteristic of ductile separation. No evidence of pre-existing corrosion or any fracture features indicative of slow crack growth was present. The hole in the failsafe chord where the fracture propagated through exhibited elongation in the inboard/outboard direction suggesting a tensile stress causing the fracture. The fracture surfaces of the web and shear tie at this location were characterized by slanted profiles with fracture topographies typical of ductile separation.

The other end of this submitted frame segment was fractured at S-51R through the failsafe chord, shear tie and web. All of the fractures exhibited significant post fracture damage consisting of mechanical damage (i.e. rub) and corrosion due to immersion in salt water. The preserved fracture surfaces exhibited slanted fracture profiles with overall fracture topographies consistent with ductile separation when viewed using visual and low power optical techniques.

Visual examination of the shear ties from this frame segment was performed to determine the direction of separation from the skin. The shear tie between S-51R and S-51L was missing the skin attachment rivets and contained no fractures, however, the skin flange was bent in the downward direction. The shear tie between S-51L and S-50L was fractured at the inboard most fastener hole common to the skin flange. The middle fastener hole was deformed in the downward direction. The outboard most rivet remained in the skin flange with the manufactured countersink head pulled off (see Figure 83). This shear tie also exhibited downward deformation of the skin flange. The shear tie between S-50L and S-49L was also missing the skin attachment rivets and exhibited downward deformation of the middle skin flange fastener hole. In addition, the stringer clip at S-51L exhibited a bearing fracture through one of the attachment lugs. All these observations were consistent with the application of a straight tensile load on the shear ties of this frame segment.

Spectrochemical analysis, hardness, and conductivity testing of samples of the failsafe chord and shear tie confirmed the drawing required materials of 7075-T62 and 2024-T42 aluminum alloys, respectively. Results of this testing are provided in Tables XI and XII.

STA 2040 Frame Segment Between S-50L to S-42R (Item 740):

Figure 84 and 85 provide overall views of the aft and forward faces of this frame segment submitted for examination.

The failsafe chord, web, and shear tie all were fractured at S-51L. At S-42R the fracture was common with the failsafe chord and web. Examination of these fracture surfaces with the use of visual and low power optical techniques revealed slanted fracture profiles with no evidence of any pre-existing corrosion or slow crack growth regions. The overall fracture morphologies were consistent with ductile separation. At S-51R, the failsafe chord was fractured at the free flange radius with deformation consistent with compression buckling (see Figure 86). All of the inner chord fractures exhibited slanted fracture profiles with fracture morphologies consistent with ductile separation as well.

All of the shear ties on this frame segment with the exception of the two at the far right side (between S-42R and S-44R) exhibited no fractures. The extruded "T" shear tie between S-42R and S-43R was fractured through the forward skin flange while the sheet metal shear tie between S-43R and S-44R was fractured through the free flange. Visual and low power optical examination of these fracture surfaces revealed slanted fracture profiles with fracture morphologies typical of ductile separation. The remainder of the shear ties on this frame experienced skin flange rivet fractures. These rivet fractures were examined to help determine the direction of loading during separation from the skin. The skin flange rivets present on the three shear ties between S-45R and S-48R exhibited evidence of loading in the forward to forward/inboard direction (see Figure 87) while the four shear ties between S-48R and S-51L exhibited evidence of loading in the aft/outboard direction (note the direction of loading for the shear tie between S-51R and S-51L was identical to the other three shear ties) (see Figure 88). All these shear ties exhibited no deformation except for the location between S-45R and S-46R which exhibited forward deformation.

Spectrochemical analysis, hardness and conductivity measurement performed on samples of the failsafe chord and inner chord from this frame segment confirmed these items were fabricated from the drawing required 7075 aluminum alloy in the T6 type temper. The shear tie sampled was verified using the same

methods as 2024 aluminum alloy in the T4 type temper in accordance with the drawing requirements (see Table XI and XII for details).

STA 1940 Frame Segment between S-50L and S-43L (Item 2086):

The as-received condition of this frame segment is shown in Figures 89 and 90. This frame segment contained two repairs of shear tie locations and one repair to the web. The shear ties were repaired between S-50L and S-49L with the use of a doubler (see Figure 91) and between S-46L and S-44L with the use of a replacement shear tie/doubler combination (see Figure 92). The web was repaired with the use of a doubler placed on the aft side under the cut-out between S-50L and S-49L (see Figure 93).

The frame segment was fractured at the failsafe chord, web, and shear tie at S-50L. Visual and low power optical examination of all of these fracture surfaces revealed slanted fracture profiles with fracture topographies consistent with ductile separation. No evidence of pre-existing cracking or corrosion was observed on any of these fractures. The inner chord at S-50L was also fractured and exhibited a slanted fracture profile. Low power optical examination of this fracture surface revealed a considerable degree of post fracture mechanical damage (i.e. rub), however, localized areas that could be viewed exhibited a fracture morphology consistent with ductile separation. The inner chord was also fractured through the free flange between S-50L and S-48L. Examination of these fracture surfaces also revealed slanted profiles with fracture morphologies typical of ductile separation. Between S-44L and S-43L the fracture was common to the failsafe chord and web. The fractures at this location exhibited slanted profiles, however, a very heavy deposit existed precluding a closer examination to determine the fracture morphology. Attempts to remove this deposit using surfactants and solvents were unsuccessful. No obvious signs of deformation that would indicate a direction of loading or fracture were observed on any of these fractures. Localized deformation was observed on the failsafe chord in the upward direction just outboard of S-49L and in the downward direction just outboard of S-48L and S-46L.

The shear ties present on this frame segment were examined for evidence of separation direction from the skin. This frame segment exhibited fractured shear ties at two locations: between S-45L and S-44L and between S-45L and S-46L. The repair shear tie between S-45L and S-44L was fractured through the inboard most hole by what appeared to be a bearing type fracture. The deformation was observed at this location in the outboard direction. The remaining skin flange attachment rivets were fractured in an outboard direction as well (see Figure 94). The shear tie between S-46L and S-45L was fractured through the free flange of the production shear tie and therefore no separation direction observations were made. Visual and low power optical examination of this fracture surface revealed a slanted profile with a morphology consistent with ductile separation. The remaining shear ties were not fractured but exhibited either fractured skin flange attachment rivets or deformation. These skin flange attachment rivets were examined using visual and low power optical techniques to determine if any evidence of loading direction was present. On the shear tie between S-50L and S-49L three of the skin flange attachment rivets were fractured in the forward to outboard direction while the inboard most rivet exhibited evidence of an inboard direction of loading (see Figure 95). All the skin flange attachment rivets of the shear tie between S-49L and S-48L showed signs of fracture in the forward to inboard direction (see Figure 96). The skin flange attachment rivets for the shear tie between S-48L and S-47L were not fractured but the shear tie exhibited general deformation in the aft direction. On the shear tie between S-47L and S-46L the two outboard most skin flange attachment rivets were fractured in the forward to outboard direction while the two inboard most rivets exhibited evidence of an aft to outboard direction of loading (see Figure 97).

Between S-47L and S-44L the stringer clips were missing from this frame segment. The rivet fractures and or hole deformation at these locations were examined to determine if any evidence of separation direction was present. At all of these stringer clip locations the rivets were fractured and remained in the shear tie except at the lower attachment hole at S-47L which was missing the rivet. All of the fractured rivets that could be viewed (some of the fractures existed at the web/shear tie interface) exhibited signs of loading in the downward direction. The lower attachment hole at S-47 exhibited elongation in the downward direction as well (see Figure 98).

Spectrochemical analysis, hardness and conductivity measurement performed on samples of the failsafe chord and inner chord from this frame segment confirmed these items were fabricated from the drawing required 7075 aluminum alloy in the T6 type temper. The shear tie sampled was verified using the same

methods as 2024 aluminum alloy in the T4 type temper in accordance with the drawing requirements (see Tables XI and XII details).

CONCLUSIONS:

1. The item 640 skin fracture common to the second row of rivets above S-49L initiated from multiple through-thickness fatigue cracks centered about STA 2100. The length of this fatigue region was 15.1 inches. Additional through-thickness propagating fatigue cracks were present as far forward as hole +14 (~ STA 2061) and as far aft as hole 51 (~ STA 2134). The cumulative length of all fatigue cracks was 25.2 inches.
2. Beyond the main fatigue region, the cracking mechanism transitioned from through-thickness propagating fatigue (Stage II, striation-producing) and matured to quasi-stable incremental growth in the forward and aft directions. Evidence of progression of the crack in this quasi-stable manner prior to the accident flight (onset of unstable ultimate separation) was observed as far forward as STA 2055 and as far aft as STA 2146 (approximately 93 inches).
3. All of the fatigue cracks initiated from longitudinal scratches on the faying surface of the skin with the doubler (original exterior surface of skin) from multiple origins except for a few discreet cracks forward of approximately STA 2068 and aft of approximately STA 2112.
4. The scratches initiating the main fatigue crack centered about STA 2100 ranged in depth from 0.0043 inch to 0.0056 inch and were consistent with unremoved damage induced during a previous tail strike event (ref. 2).
5. The skin scratches were most severe in the left hand / forward region of the skin covered by the repair doubler.
6. The faying surface of the repair doubler contained a deposit of paint matching the paint on the exterior surface of the doubler. The paint deposit was centered about STA 2100 in the same area as the main fatigue crack. Local outward deformation of the doubler with the fractured skin was reported at STA 2100 in the CSIST report. These observations suggest that the doubler and fractured skin were locally displaced from the unrecovered portion of the skin prior to the last repaint of this area.
7. Numerous hoop-wise fretting marks were observed on the overhanging portion of the faying surface of the doubler from approximately STA 2061 to STA 2132. The source of this fretting damage was not conclusively determined but based on its location with respect to fatigue cracking and further progression of the crack in a quasi-stable manner, it is most likely the result of repeated crack opening during propagation prior to the accident flight.
8. All of the frame segment members submitted for examination fractured by ductile separation with no evidence of pre-existing damage (i.e. slow crack growth or corrosion) with the exception of the STA 2160 frame which exhibited extensive pre-existing exfoliation corrosion at the two shear tie locations between S-50L and S-48L.
9. Spectrochemical analysis, hardness and conductivity measurements confirmed that the failsafe chord, inner chord, and shear tie members of the frame segments submitted for examination were fabricated from the drawing required materials and tempers. The material and temper used for the shear tie repair at STA 2160 was 2024-T4X contrary to the drawing required 7075-T62.

Table I.

Description of wreckage items submitted to BMT for examination.

ASC Assigned Item Number	General Description	Boeing Part Number	Boeing Part Name	Material & Heat Treat	Material Specification	Finish
640C1	Section 46 Skin Panel – STA 2060 to 2180, S-49L to S-49R	65B04152	Skin Panel Instl – STA 1961.10 to STA 2181.10, S-46L to S-46R	Skin – Clad 2024-T3	Skin – QQ-A-250/5	Interior surface - chromic acid anodize + one coat of BMS 10-11 primer + BMS 10-11 enamel
	Frame Segment – STA 2160, S-49L to S-51L	65B04345	Frame Instl – Body STA 2160, Lower Lobe	Shear Ties – 7075-T62 Failsafe Chord - 7075-T62	Shear Ties – QQ-A-250/12 Failsafe Chord QQ-A-200/11	Same as Item 2015
640C2	Section 46 Skin Panel – STA 2046 to 2060, S-49L to S-49R	65B04152	Skin Panel Instl – STA 1961.10 to STA 2181.10, S-46L to S-46R	Skin – Clad 2024-T3	Skin – QQ-A-250/5	Same as 640C1
2015	Frame Segment – STA 2100, S-49L to S-48R	65B04342	Frame Instl – STA 2100, Lower Lobe	Shear Ties – 2024-T42 Inner Chord – 7075-T6511 Failsafe Chord – 7075-T62	Shear Ties – QQ-A-250/4 Inner Chord – QQ-A-200/11 Failsafe Chord QQ-A-200/11	Alodine or chromic acid anodize + one coat of BMS 10-11 primer + BMS 10-11 enamel
2014	Frame Segment – STA 2060, S-49L to S-51R	65B04340	Frame Instl – STA 2060, Lower Lobe	Shear Ties – 2024-T42 Failsafe Chord – 7075-T62	Shear Ties – QQ-A-250/4 Failsafe Chord QQ-A-200/11	Same as Item 2015
740	Frame Segment – STA 2040, S-50L to S-42R	65B04339	Frame Instl – Body Station 2060, Lower Lobe	Same as Item 2015	Same as Item 2015	Same as Item 2015
2086	Frame Segment – STA 1940, S-50L TO S-43L	65B04334	Frame Instl – Body Station 1940, Lower Lobe	Same as Item 2015	Same as Item 2015	Same as Item 2015

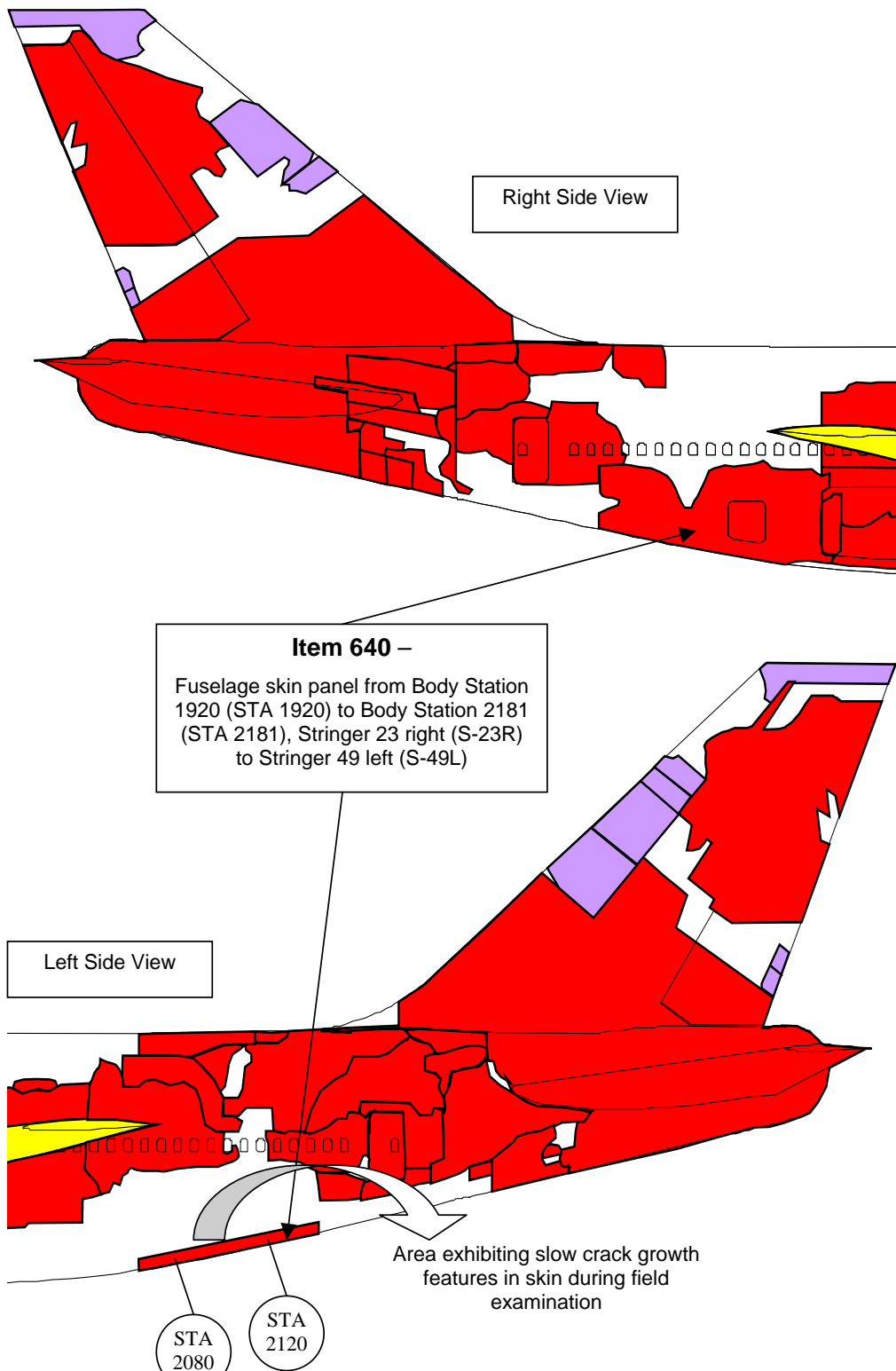

Figure 1.
Partial wreckage recovery map for CI611 showing the location of the item 640 skin panel and the area where slow crack growth features were found in the skin along S-49L during field examination.

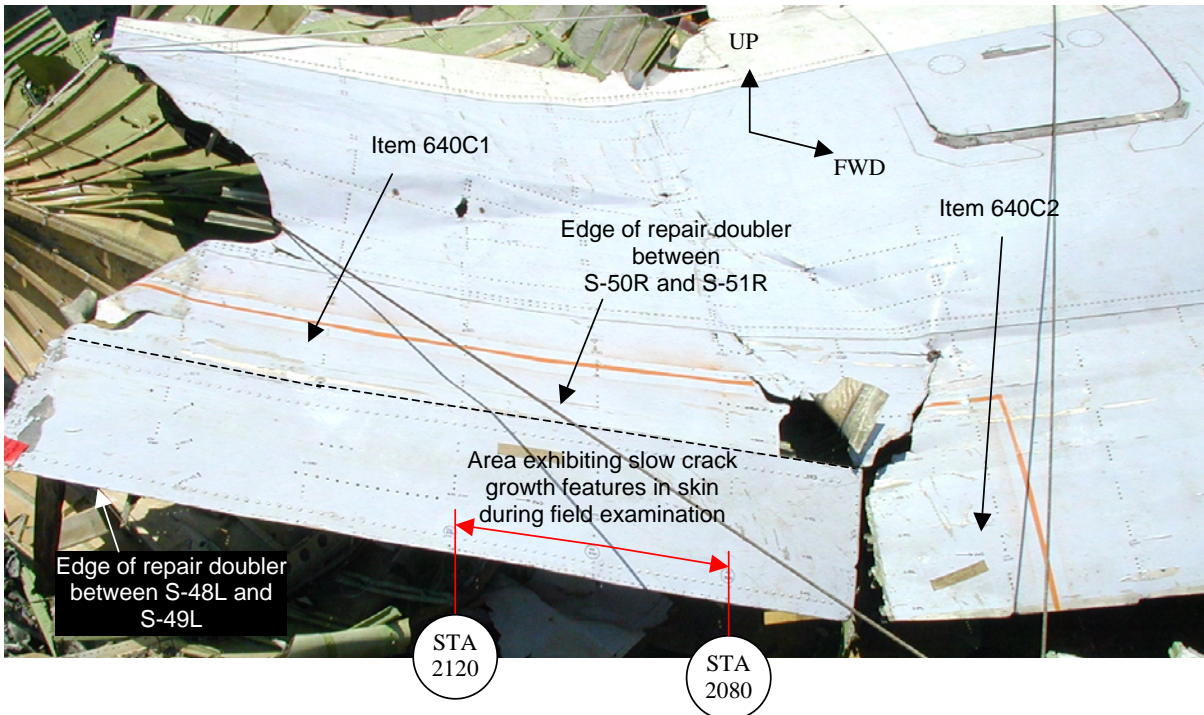

Figure 2.

Item 640C1 and C2 Skin panel segments prior to removal from the parent item 640 wreckage in Makung, Taiwan.

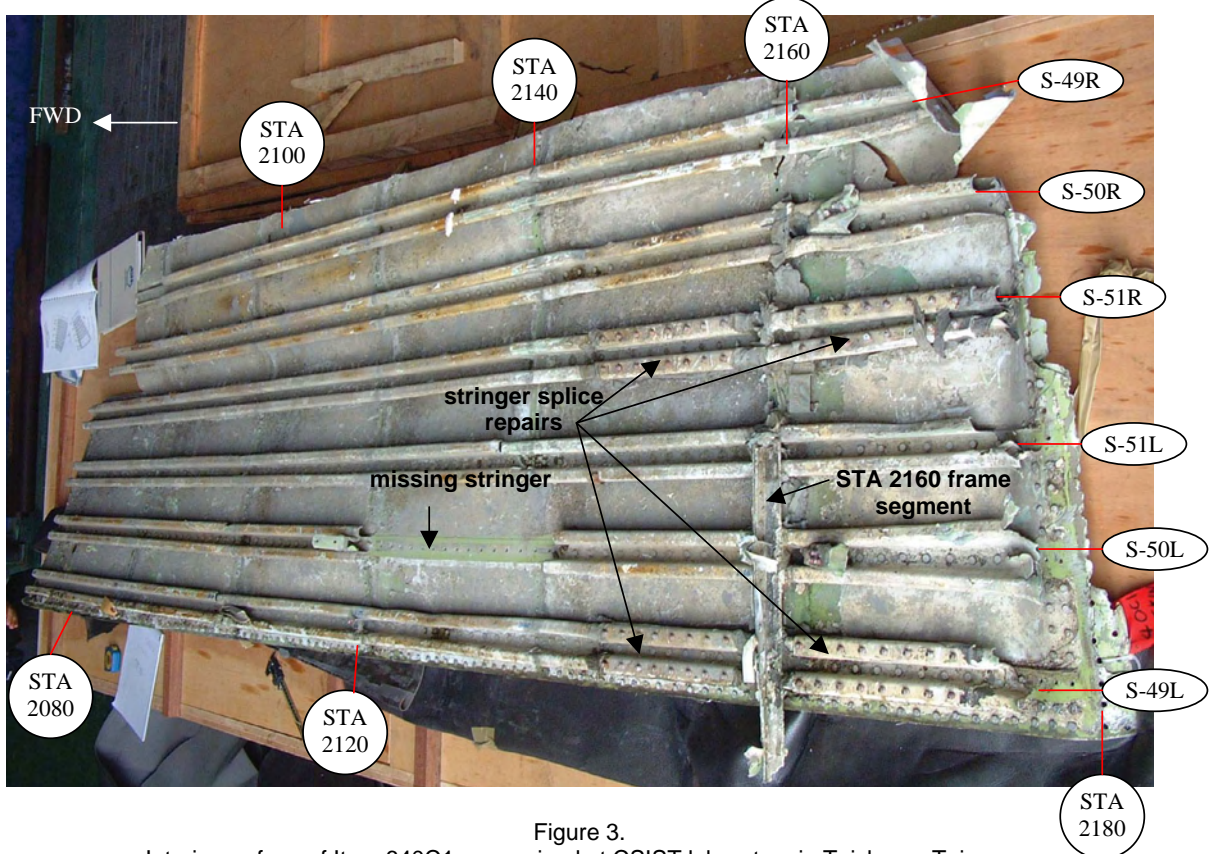

Figure 3.

Interior surface of Item 640C1 as received at CSIST laboratory in Taichung, Taiwan.

Table II.

Schematic representation of shear tie and stringer clip attachment to item 640C1 and C2 skin sections.

STA	2040	2060	2080	2100	2120	2140	2160
	<i>saw cut</i>		<i>saw cut</i>				
		<i>missing segment</i>					
			Note 1	O O O	O O O	Note 1	Note 1
S-49R	OG SS			SS OS	OS SS	OS OG	OX XS
	O O O O		O O O O	O O O O	O O O O	O O O O	O O O O
S-50R	SO SS		SS SS	OS SS	SS SS	OS OS	GG OS
	O O O	X T	O O T	O O T	O O T	O O S	Note 3 O
S-51R	OG SG	XH SH	SS SS	SS SS	SS SG	SS XO	HH HH
	O O O O	O O O O	T O O O	T T T O	T T T O	S S S S	O O O O
S-51L	SO SS	TX OG	SS SS	SG GG	SS SS	TS XO	HS HS
	O O O	T T O	T T T	T T T	O O O	S S S	Note 4,5
S-50L	OS OO	OX SG	SS SS	OO SX	GO GO Note 6	Note 8	Note 10
	O O O O	O O S	Note 2	O T T	T T T	O O T	Note 4
S-49L	GG XG	OX SX	OS SO	GG XG	GG GG Note 7	OS GG	Note 9

stringer fracture (arrow pointing to the fracture line between S-49R and S-50R)

outline of repair doubler (red dashed lines at the bottom)

Table II Continued

LEGEND:

- S = Solid rivet that failed in shear. Portion of fastener remains.
 - O = Fastener is missing.
 - T = Fastener remains in hole, suggesting tensile pull-away for shear tie locations.
 - G = Fastener remains in hole retaining segment of the stringer clip.
 - H = Hi-Lok fastener remains. All Hi-Lok fasteners at the stringer clip locations were observed to retain a segment of a fractured stringer clip.
 - X = Stringer is cracked/fractured through this area. The fastener is missing.
-
- Note 1: Three Hi-Lok fasteners retain a piece of shear tie with residual upward deformation.
 - Note 2: Four solid rivets retain a piece of shear tie with residual upward deformation.
 - Note 3: Two solid rivets retain a piece of shear tie with residual upward deformation.
 - Note 4: Shear ties are still attached to skin and portion of frame which exhibits up and aftward deformation.
 - Note 5: Rivets are partially pulled through, completely through doubler but remaining in skin and shear tie.
 - Note 6: Complete stringer clip still attached to stringer with two fwd rivets. Clip is missing all other fasteners. One hole common to frame is elongated upward. Stringer is fractured through two aft holes.
 - Note 7: Stringer clip fractured with extensive residual deformation (includes crushing). All fasteners common to stringer remain.
 - Note 8: Stringer segment missing at this location.
 - Note 9: Portion of frame remains attached to stringer at this location with aftward deformation. Fasteners common to stringer and clip are Hi-Loks.
 - Note 10: Portion of frame remains attached to stringer at this location with aftward deformation. Fasteners common to stinger are Hi-Loks on FWD side and rivets on AFT side.

Figure 4.

Schematic showing the spacing of the two rows of rivets in relationship to S-49L and the edge of the doubler.

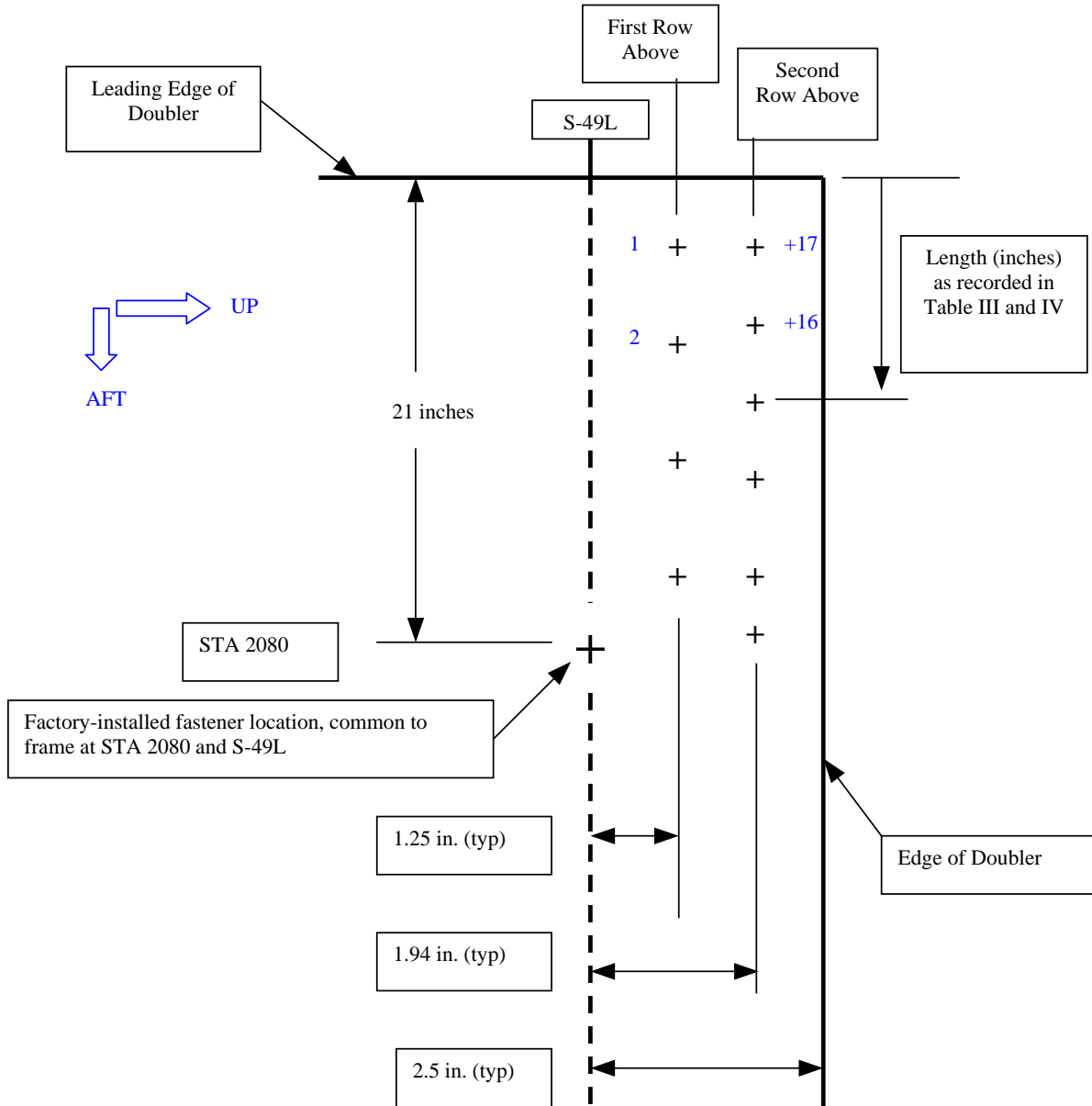

Table III

Repair doubler rivet spacing and driven rivet dimensions for first row above S-49L.

Rivet No.	Body Station Reference	Length from Leading Edge of Doubler (inches)	Driven Rivet Button Diameter (inch)	Driven Rivet Button Thickness or Height (inch)	Notes
1		0.69	0.322	0.103	underdriven
2		1.44	0.300	0.124	underdriven
3		2.50	0.343	0.070	overdriven
4		3.88	0.325	0.068	overdriven
5		5.31	0.350	0.060	overdriven
6		6.69	0.337	0.060	overdriven
7		8.06	0.339	0.060	overdriven
8		9.50	0.340	0.060	overdriven
9		10.81	0.337	0.060	overdriven
10		12.25	0.339	0.060	overdriven
11		13.69	0.344	0.070	overdriven
12		15.00	0.337	0.071	overdriven
13		16.38	0.337	0.069	overdriven
14		17.69	0.327	0.103	
15		19.06	0.313	0.082	overdriven
16		20.38	0.365	0.078	overdriven
17	~2081	21.38	0.388	0.073	overdriven
18		23.50	0.325	0.084	overdriven
19		25.06	0.337	0.081	overdriven
20		26.38	0.387	0.065	overdriven
21		27.63	0.318	0.093	overdriven
22		29.06	0.339	0.068	overdriven
23		30.38	0.338	0.071	overdriven
24		31.75	0.300	0.101	
25		33.25	0.325	0.096	overdriven
26		34.63	0.331	0.076	overdriven
27		36.00	0.336	0.062	overdriven
28		37.56	0.358	0.058	overdriven
29		38.94	0.331	0.076	overdriven
30		40.38	0.373	0.061	overdriven
31	2100	41.75	0.391	0.077	overdriven
32		43.19	0.315	0.115	underdriven
33		44.56	0.37	0.076	overdriven
34		45.94	0.36	0.065	overdriven
35		47.25	0.35	0.067	overdriven
36		48.75	0.38	0.064	overdriven
37		50.19	0.35	0.068	overdriven

Table III Continued

Rivet No.	Body Station Reference	Length from Leading Edge of Doubler (inches)	Driven Rivet Button Diameter (inch)	Driven Rivet Button Thickness or Height (inch)	Notes
38		51.63	0.33	0.068	Overdriven
39		52.94	0.32	0.082	overdriven
40		54.44	0.342	0.060	overdriven
41		55.88	0.327	0.069	overdriven
42		57.38	0.335	0.067	overdriven
43		58.75	0.337	0.075	overdriven
44		60.25	0.348	0.061	overdriven
45		61.50	0.334	0.066	overdriven
46	~2121	63.00	0.307	0.087	overdriven
47		64.38	0.331	0.060	overdriven
48		65.75	0.344	0.055	overdriven
49		67.06	0.328	0.056	overdriven
50		68.44	0.324	0.075	overdriven
51		69.88	0.327	0.065	overdriven
52		71.25	0.335	0.068	overdriven
53		72.63	0.336	0.067	overdriven
54		74.00	0.332	0.057	overdriven
55		75.50	0.356	0.063	overdriven
56		76.94	0.348	0.061	overdriven
57		78.19	0.370	0.058	overdriven
58		79.50	0.348	0.050	overdriven
59		80.75	0.355	0.053	overdriven
60	2140	82.44	0.343	0.053	overdriven
61		83.94	0.357	0.118	
62		85.25	0.349	0.095	overdriven
63		86.63	0.360	0.090	overdriven
64		88.00	0.351	0.060	overdriven
65		89.56	0.340	0.095	overdriven
66		90.88	0.341	0.096	overdriven
67		92.25	0.317	0.100	
68		93.69	0.358	0.100	
69		95.00	0.320	0.100	underdriven
70		96.38	0.370	0.095	overdriven
71		97.88	0.367	0.100	
72		99.25	0.382	0.090	overdriven
73		100.63	0.370	0.110	
74		102.00	0.330	0.150	
75	~2161	103.63	0.298	0.150	underdriven
76		104.88	0.321	0.160	underdriven
77		106.19	0.332	0.105	

Table III Continued

Rivet No.	Body Station Reference	Length from Leading Edge of Doubler (inches)	Driven Rivet Button Diameter (inch)	Driven Rivet Button Thickness or Height (inch)	Notes
78		107.56	0.350	0.094	overdriven
79		109.00	0.370	0.092	overdriven
80		110.44	0.390	0.087	overdriven
81		111.75	0.367	0.127	
82		113.19	0.378	0.107	
83		114.69	0.364	0.116	
84		116.13	0.350	0.100	
85		117.38	0.368	0.085	overdriven
86		118.88	0.396	0.082	overdriven
87		120.13	0.361	0.080	overdriven
88		121.13	0.358	0.083	overdriven
89		122.00	0.401	0.094	overdriven
90		123.25	missing	missing	
91		124.19	missing	missing	
AFT Edge of Doubler		124.81	n/a	n/a	

Table IV

Repair doubler rivet spacing and driven rivet dimensions for second row above S-49L.

Rivet No.	Body Station Reference	Length from Leading Edge of Doubler (inches)	Driven Rivet Button Diameter (inch)	Driven Rivet Button Thickness or Height (inch)	Notes
+17		0.31	missing	missing	
+16	~2061	1.50	0.367	0.091	overdriven
+15		2.50	0.359	0.085	overdriven
+14		3.56	0.334	0.101	
+13		4.56	0.357	0.113	
+12		5.81	0.349	0.100	
+11		7.06	0.400	0.080	overdriven
+10		8.19	0.345	0.095	overdriven
+9		9.38	0.357	0.095	overdriven
+8		10.50	0.368	0.095	overdriven
+7		11.63	0.357	0.088	overdriven
+6		12.81	0.356	0.096	overdriven
+5		14.00	0.331	0.105	
+4		15.25	0.350	0.105	
+3		16.56	0.333	0.114	
+2		17.88	0.393	0.070	overdriven
+1		19.25	0.356	0.100	
0		20.06	0.371	.1035/.0835	overdriven
1	2080	21.00	0.213	0.138	blind rivet
2		22.50	0.319	0.111	half bucked
3		23.81	0.421	0.076	overdriven
4		25.00	0.397	0.062	overdriven
5		26.44	0.389	0.091	overdriven
6		27.63	0.393	.0805/.094	overdriven
7		29.19	0.422	0.077	overdriven
8		30.75	0.389	.0735/.0835	overdriven
9		32.00	0.395	.0725/.095	overdriven
10		33.19	0.428	0.080	overdriven
11		34.38	0.400	0.077	overdriven
12		35.44	0.385	0.075	overdriven
13		36.63	0.400	0.079	overdriven
14		37.69	0.399	0.077	overdriven
15		38.75	0.374	0.088	overdriven
16		39.81	0.401	0.075	overdriven
17		40.81	0.373	0.088	overdriven
18	2100	41.63	0.237	0.136	blind rivet
19		42.19	0.399	0.058	overdriven

Table IV Continued

Rivet No.	Body Station Reference	Length from Leading Edge of Doubler (inches)	Driven Rivet Button Diameter (inch)	Driven Rivet Button Thickness or Height (inch)	Notes
20		43.25	0.424	0.074	overdriven
21		44.50	0.413	0.081	overdriven
22		45.56	0.384	0.087	overdriven
23		46.56	0.380	.0975/.08	overdriven
24		47.63	0.348	.0955/.0925	overdriven
25		48.63	0.370	.0855/.095	overdriven
26		49.81	0.383	0.073	overdriven
27		50.81	0.377	0.070	overdriven
28		52.06	0.355	0.100	
29		53.25	0.358	0.095	overdriven
30		54.44	0.369	0.072	overdriven
31		55.63	0.326	0.110	
32		56.75	0.340	0.094	overdriven
33		57.81	0.357	0.081	overdriven
34		58.81	0.352	0.088	overdriven
35		59.81	0.346	0.103	
36		60.69	0.364	0.082	overdriven
37		61.50	.3125/.289	0.100	underdriven
38	2120	62.00	0.277	0.121	7/32 rivet
39		63.19	0.360	0.109	
40		64.38	0.351	0.096	overdriven
41		65.31	0.347	0.100	
42		66.44	0.358	.111/.0725	overdriven
43		67.56	0.338	0.108	
44		68.75	0.376	0.089	overdriven
45		70.06	0.361	0.100	
46		71.13	0.375	0.088	overdriven
47		72.19	0.364	0.102	
48		73.38	0.372	0.093	overdriven
49		74.50	0.365	0.084	overdriven
50		75.56	0.312	0.109	underdriven
51		76.63	0.342	0.100	
52		77.69	0.330	0.102	
53		78.75	0.333	0.096	overdriven
54		79.88	0.350	0.100	
55		80.31	0.322	0.106	underdriven
56	2140	82.50	missing	missing	hole cut during disassembly
57		83.50	0.355	0.102	
58		84.63	0.407	0.096	overdriven

Table IV Continued

Rivet No.	Body Station Reference	Length from Leading Edge of Doubler (inches)	Driven Rivet Button Diameter (inch)	Driven Rivet Button Thickness or Height (inch)	Notes
59		85.75	0.365	0.104	
60		86.75	0.378	0.100	
61		87.81	0.394	0.080	overdriven
62		88.94	0.386	0.086	overdriven
63		89.94	0.358	0.089	overdriven
64		90.88	0.361	0.087	overdriven
65		91.88	0.370	0.076	overdriven
66		92.94	0.394	0.082	overdriven
67		94.06	0.365	0.083	overdriven
68		95.50	0.350	0.088	overdriven
69		96.63	0.363	0.085	overdriven
70		97.88	0.386	0.079	overdriven
71		99.00	0.361	0.088	overdriven
72		100.13	0.388	0.075	overdriven
73		101.38	0.381	0.076	overdriven
74	2160	102.94	0.259	0.165	3/16 rivet
75		104.19	0.318	0.104	underdriven
76		105.25	0.379	0.072	overdriven
77		106.38	0.347	0.091	overdriven
78		107.38	0.346	0.103	
79		108.50	0.336	0.111	
80		109.56	0.352	0.110	
81		110.63	0.344	0.100	
82		111.75	0.372	0.075	overdriven
83		112.75	0.353	0.100	
84		114.00	0.353	0.100	
85		115.13	0.352	0.100	
86		116.25	0.365	0.086	overdriven
87		117.38	0.361	0.090	overdriven
88		118.50	0.377	0.100	
89		119.75	0.374	0.080	overdriven
90		120.81	0.381	0.075	overdriven
91		121.88	0.400	0.080	overdriven
92		123.31	missing	missing	
93		124.19	missing	missing	
AFT edge of doubler		124.81	n/a	n/a	

Table V

Repair doubler driven rivet dimensions for first and second rows above S-51R.

First Row Above S-51R					Second Row Above S-51R				
Rivet No.	Body Station Reference	Driven Rivet Button Diameter (inch)	Driven Rivet Button Thickness or Height (inch)	Notes	Rivet No.	Body Station Reference	Driven Rivet Button Diameter (inch)	Driven Rivet Button Thickness or Height (inch)	Notes
1		0.30	N/A		+16		missing	missing	
2		0.33	0.12		+15		0.303	0.152	underdriven
3		0.32	0.08	Overdriven	+14		0.327	0.121	
4		0.35	0.08	Overdriven	+13		0.335	0.106	
5		0.43	0.10		+12		0.352	0.103	
6		0.33	0.09	Overdriven	+11		0.328	0.127	
7		0.33	0.08	Overdriven	+10		0.341	0.115	
8		0.31	0.09	Overdriven	+9		0.341	0.108	
9		0.32	0.08	Overdriven	+8		0.341	0.109	
10		0.31	0.10		+7		0.349	0.091	overdriven
11		0.32	0.09	Overdriven	+6		0.329	0.109	
12		0.35	0.09	Overdriven	+5		0.335	0.118	
13		0.35	0.09	Overdriven	+4		0.320	0.131	underdriven
14		0.34	0.15		+3		0.352	0.117	
15		0.35	0.08	Overdriven	+2		0.316	0.130	underdriven
16	~2081	0.35	0.09	Overdriven	+1		0.333	0.134	
17		0.35	0.08	Overdriven	+0		0.362	0.107	
18		0.36	0.08	Overdriven	1	2080	0.299	0.153	3/16 rivet
19		0.34	0.08	Overdriven	2		0.331	0.114	
20		0.36	0.08	Overdriven	3		0.344	0.120	
21		0.33	0.11		4		0.344	0.114	
22		0.35	0.08	Overdriven	5		0.362	0.104	
23		0.34	0.16		6		0.355	0.106	
24		0.33	0.07	Overdriven	7		0.356	0.103	
25		0.34	0.08	Overdriven	8		0.383	0.095	overdriven
26		0.34	0.07	Overdriven	9		0.384	0.070	overdriven
27		0.35	0.08	Overdriven	10		0.349	0.106	
28		0.34	0.08	Overdriven	11		0.349	0.107	
29		0.35	0.09	Overdriven	12		0.375	0.090	overdriven
30	2100	0.32	0.10		13		0.354	0.100	
31		0.37	0.08	Overdriven	14		0.368	0.100	
32		0.34	0.09	Overdriven	15		0.360	0.089	overdriven

Table V Continued

First Row Above S-51R					Second Row Above S-51R				
Rivet No.	Body Station Reference	Driven Rivet Button Diameter (inch)	Driven Rivet Button Thickness or Height (inch)	Notes	Rivet No.	Body Station Reference	Driven Rivet Button Diameter (inch)	Driven Rivet Button Thickness or Height (inch)	Notes
34		0.34	0.10		17		0.377	0.086	overdriven
35		0.35	0.09	overdriven	18		0.376	0.087	overdriven
36		0.34	0.08	overdriven	19		0.392	0.084	overdriven
37		0.34	0.10		20		0.362	0.103	
38		0.32	0.10		21	2100	0.266	0.152	3/16 rivet
39		0.32	0.10		22		0.391	0.091	overdriven
40		0.35	0.14		23		0.372	0.085	overdriven
41		0.34	0.07	overdriven	24		0.352	0.101	
42		0.35	0.07	overdriven	25		0.385	0.093	overdriven
43		0.320	0.080	overdriven	26		0.363	0.098	overdriven
44		0.350	0.080	overdriven	27		0.386	0.079	overdriven
45	~2121	0.30	0.100	underdriven	28		0.372	0.086	overdriven
46		0.35	0.07	overdriven	29		0.367	0.080	overdriven
47		0.35	0.090	overdriven	30		0.393	0.081	overdriven
48		0.33	0.090	overdriven	31		0.385	0.082	overdriven
49		0.36	0.09	overdriven	32		0.371	0.090	overdriven
50		0.35	0.07	overdriven	33		0.385	0.079	overdriven
51		0.33	0.08	overdriven	34		0.389	0.075	overdriven
52		0.32	0.08	overdriven	35		0.387	0.079	overdriven
53		0.32	0.09	overdriven	36		0.387	0.073	overdriven
54		0.33	0.08	overdriven	37		0.409	0.073	overdriven
55		0.32	0.08	overdriven	38		0.410	0.075	overdriven
56		0.32	0.08	overdriven	39		0.396	0.081	overdriven
57		0.36	0.08	overdriven	40	2120	0.267	0.126	3/16 rivet
58		0.34	0.07	overdriven	41		0.343	0.119	
59	2140	0.33	0.09	overdriven	42		0.372	0.092	overdriven
60		0.34	0.08	overdriven	43		0.409	0.096	overdriven
61		0.32	0.09	overdriven	44		0.391	0.079	overdriven
62		0.31	0.10		45		0.370	0.087	overdriven
63		0.34	0.08	overdriven	46		0.383	0.092	overdriven
64		0.36	0.07	overdriven	47		0.362	0.087	overdriven
65		0.32	0.09	overdriven	48		0.362	0.087	overdriven
66		0.35	0.10		49		0.340	0.103	
67		0.35	0.08	overdriven	50		0.361	0.077	overdriven
68		0.34	0.07	overdriven	51		0.339	0.105	

Table V Continued

First Row Above S-51R					Second Row Above S-51R				
Rivet No.	Body Station Reference	Driven Rivet Button Diameter (inch)	Driven Rivet Button Thickness or Height (inch)	Notes	Rivet No.	Body Station Reference	Driven Rivet Button Diameter (inch)	Driven Rivet Button Thickness or Height (inch)	Notes
70		0.36	0.07	Overdriven	53		0.336	0.100	
71		0.35	0.08	Overdriven	54		0.352	0.092	overdriven
72		0.36	0.10		55		0.354	0.087	overdriven
73		0.35	0.10		56		0.342	0.093	overdriven
74	2160	0.36	0.09	Overdriven	57		0.335	0.105	
75		0.36	0.07	Overdriven	58		0.396	0.086	overdriven
76		0.360	0.08	Overdriven	59		0.365	0.080	overdriven
77		0.37	0.08	Overdriven	60	2140	missing?	Missing?	3/16 hole
78		0.32	0.10		61		0.348	0.112	
79		0.35	0.07	Overdriven	62		0.371	0.087	overdriven
80		0.35	0.09	Overdriven	63		0.367	0.100	
81		0.37	0.10		64		0.333	0.093	overdriven
82		0.37	0.10		65		0.360	0.087	overdriven
83		0.35	0.11		66		0.377	0.077	overdriven
84		0.36	0.07	Overdriven	67		0.448	0.062	overdriven
85		0.37	0.07	Overdriven	68		0.386	0.093	overdriven
86		0.38	0.10		69		0.354	0.097	overdriven
					70		0.384	0.084	overdriven
					71		0.377	0.087	overdriven
					72		0.386	0.090	overdriven
					73		0.390	0.078	overdriven
					74		0.393	0.075	overdriven
					75		0.391	0.055	overdriven
					76		0.408	0.072	overdriven
					77		0.414	0.083	overdriven
					78		0.399	0.078	overdriven
					79	2160	0.314	N/A	3/16 hole
					80		0.299	0.153	underdriven
					81		0.409	0.083	overdriven
					82		0.406	0.083	overdriven
					83		0.403	0.079	overdriven
					84		0.403	0.069	overdriven
					85		0.395	0.083	overdriven
					86		0.383	0.086	overdriven
					87		0.383	0.071	overdriven

Table V Continued

Second Row Above S-51R				
Rivet No.	Body Station Reference	Driven Rivet Button Diameter (inch)	Driven Rivet Button Thickness or Height (inch)	Notes
89		0.403	0.075	overdriven
90		0.393	0.081	overdriven
91		0.395	0.075	overdriven
92		0.345	0.100	
93		0.360	0.086	overdriven
94		0.360	0.083	overdriven
95		0.392	N/A	
96		0.393	N/A	
97		missing	missing	

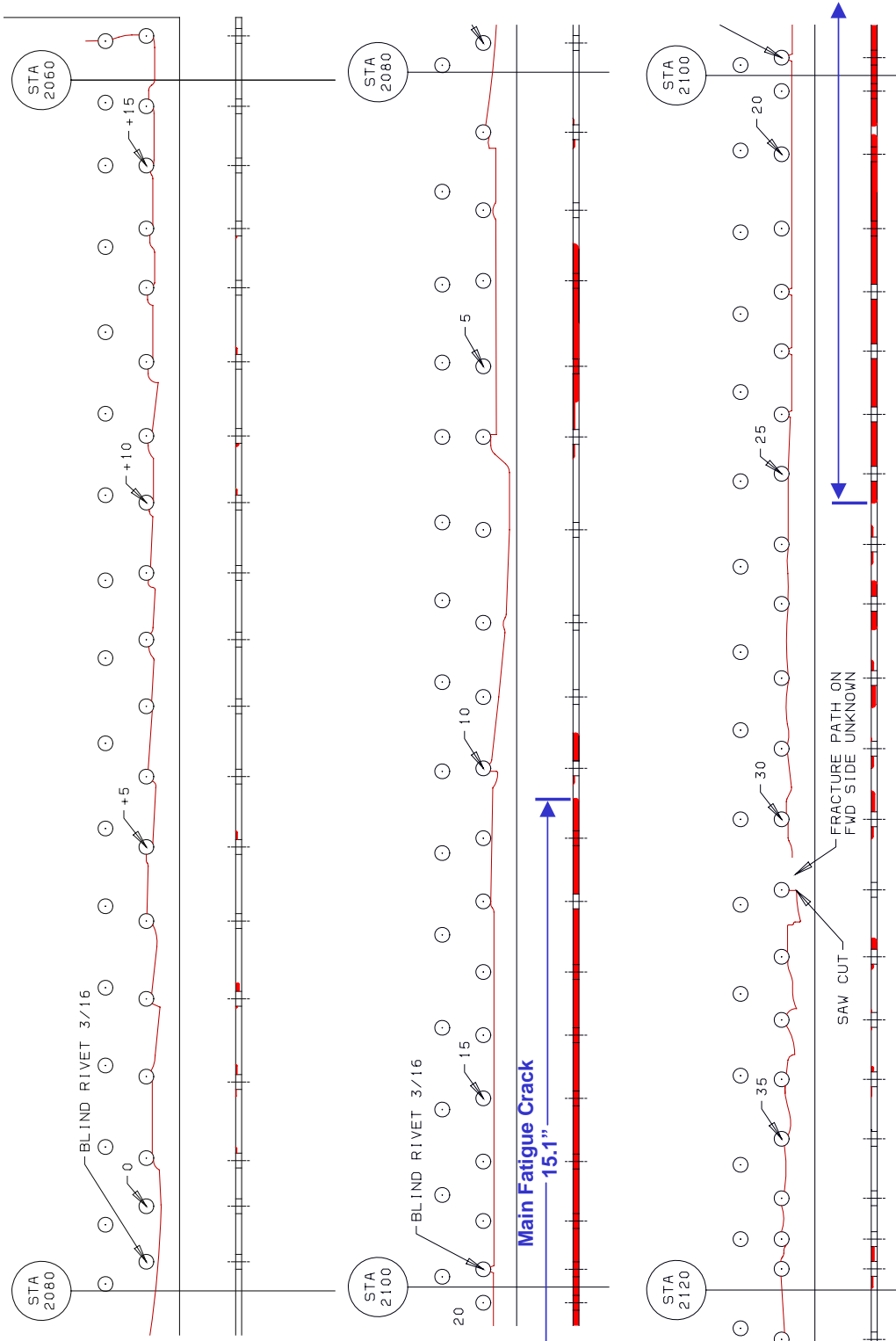

Figure 5. Map of fatigue cracking (red areas) observed on fracture above S-49L from STA 2060 to STA 2120. The length of the main fatigue crack centered about STA 2100 is shown. Refer to Table JVI for a complete list of fatigue crack lengths and depths.

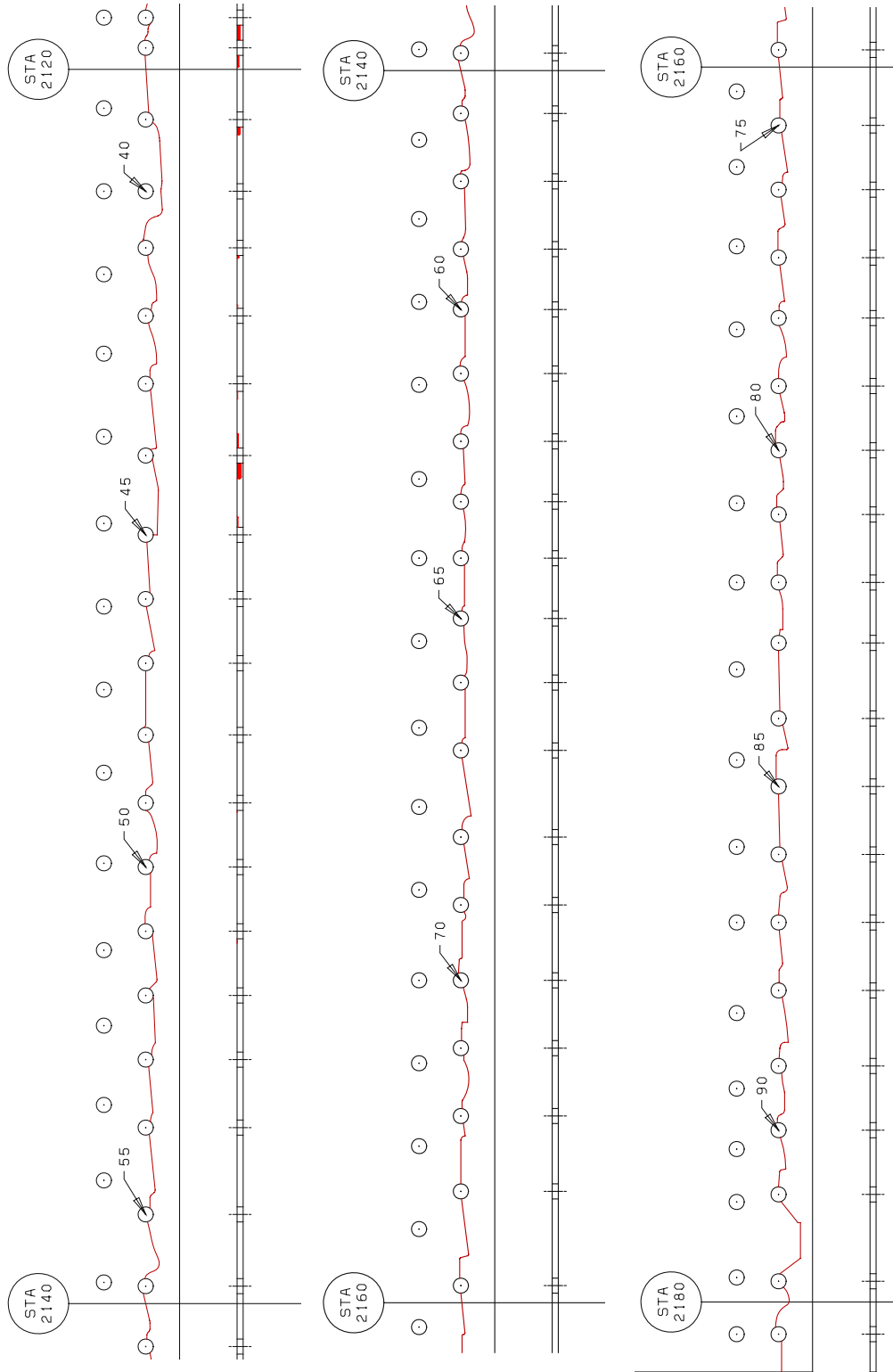

Figure 6.
Map of fatigue cracking (red areas) observed on fracture above S-49L from STA 2120 to STA 2180. Refer to Table JVI for lengths and depths of the fatigue cracks provided in this figure.

Table VI

Length, depth and origin location of fatigue cracks on fracture above S-49L.

Location	Length of Fatigue Crack (inch)	Depth of Fatigue Crack (%)	Origin of Fatigue Crack
Aft of hole +14	0.04	20	Faying surface – no scratch
Fwd of hole +12	0.12	25	Faying surface – no scratch
Aft of hole +11	0.06	60	Corner of hole at faying surface
Fwd of hole +10	0.11	25	Scratch on faying surface
Fwd of hole +5	0.14	30	Faying surface – no scratch
Fwd of hole +3	0.14	60	Scratch on faying surface
Aft of hole +3	0.03	30	Scratch on faying surface
Fwd of hole +2	0.17	25	Scratch on faying surface
Aft of hole +2	0.12	10	Scratch on faying surface
Fwd of hole 2	0.11	15	Scratch on faying surface
Aft of hole 2	0.15	30	Scratch on faying surface
Fwd of hole 4 to aft of hole 6	3.50	25-100	Scratch on faying surface
Fwd of hole 10	0.47	100	Scratch on faying surface
Aft of hole 10	0.15	25	Scratch on faying surface
Fwd of hole 11 to aft of hole 25	15.14	*95-100	Scratch on faying surface
Fwd of hole 26	0.20	30	Scratch on faying surface
Aft of hole 26	0.22	30	Scratch on faying surface
Fwd of hole 27	0.26	100	Scratch on faying surface
Aft of hole 27	0.39	100	Scratch on faying surface
Fwd of hole 28	0.18	40	Scratch on faying surface
Aft of hole 28	0.37	75	Scratch on faying surface
Fwd of hole 29	0.03	5	Scratch on faying surface
Aft of hole 29	0.21	40	Scratch on faying surface
Fwd of hole 30	0.26	60	Scratch on faying surface
Aft of hole 30	0.21	35	Scratch on faying surface
Fwd of hole 32	0.22	90	Scratch on faying surface
Aft of hole 32	0.09	40	Scratch on faying surface
Fwd of hole 33	0.04	10	Faying surface – no scratch
Aft of hole 33	0.04	10	Faying surface – no scratch
Fwd of hole 34	0.09	40	Scratch on faying surface
Aft of hole 34	0.17	10	Scratch on faying surface
Fwd of hole 35	0.02	5	Scratch on faying surface
Aft of hole 37 to fwd of hole 38	0.50	50-60	Faying surface – no scratch
Aft of hole 38	0.09	30	Countersink bore
Aft of hole 39	0.14	50	Faying surface – no scratch
Fwd of hole 41	0.05	30	Faying surface – no scratch
Fwd of hole 42	0.06	10	Faying surface – no scratch
Aft of hole 43	0.13	10	Faying surface – no scratch
Fwd of hole 44	0.23	20	Scratch on faying surface
Aft of hole 44	0.26	70	Scratch on faying surface
Fwd of hole 45	0.49	15	Scratch on faying surface
Aft of hole 49	0.02	2	Faying surface – no scratch
Aft of hole 51	0.07	5	Faying surface – no scratch

* The crack depth at a local area forward of hole 20 was 5%.

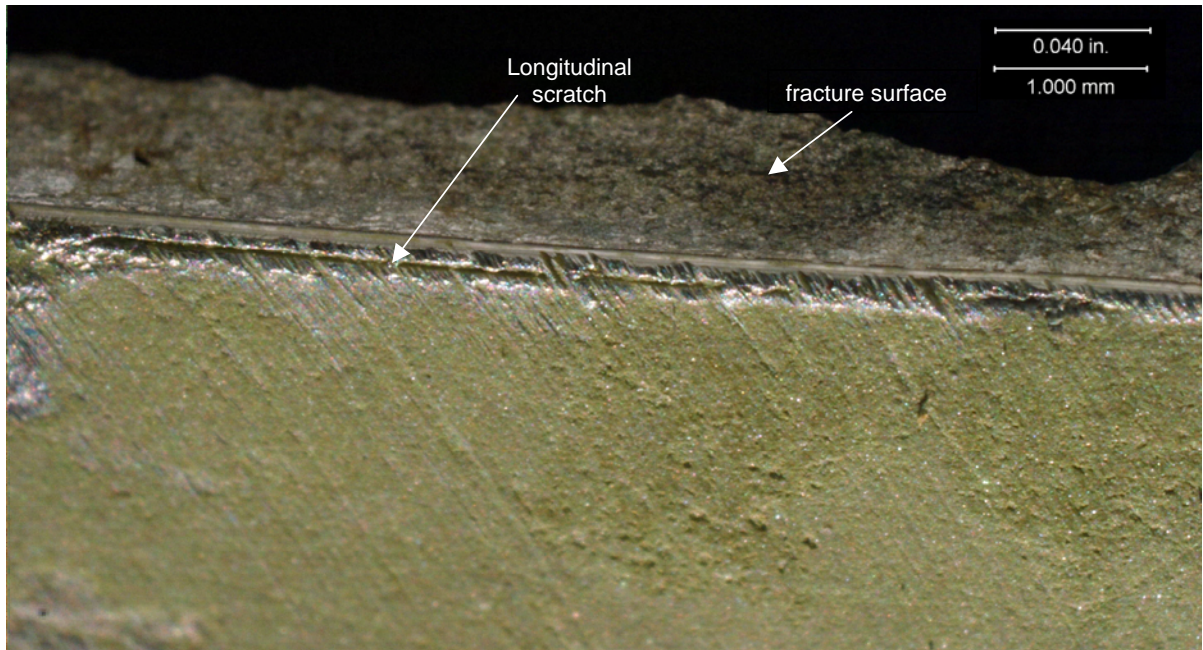

Figure 7.
Surface of skin faying with repair doubler near hole 20 showing the longitudinal scratch where fatigue crack initiation occurred from multiple origins. Also note the sanding marks induced during rework of the skin.

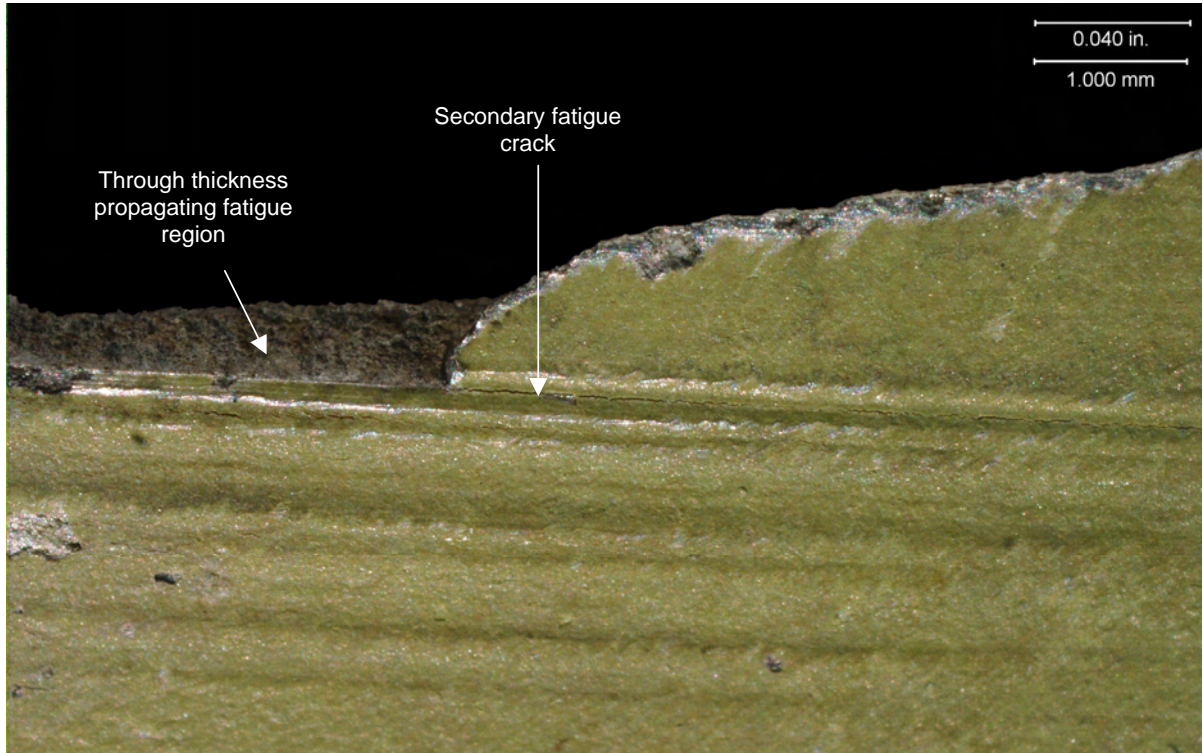

Figure 8.
Surface of skin faying with repair doubler between hole 29 and hole 30 showing the longitudinal scratches in relationship to this fatigue crack. Note the secondary crack extending out of this common scratch.

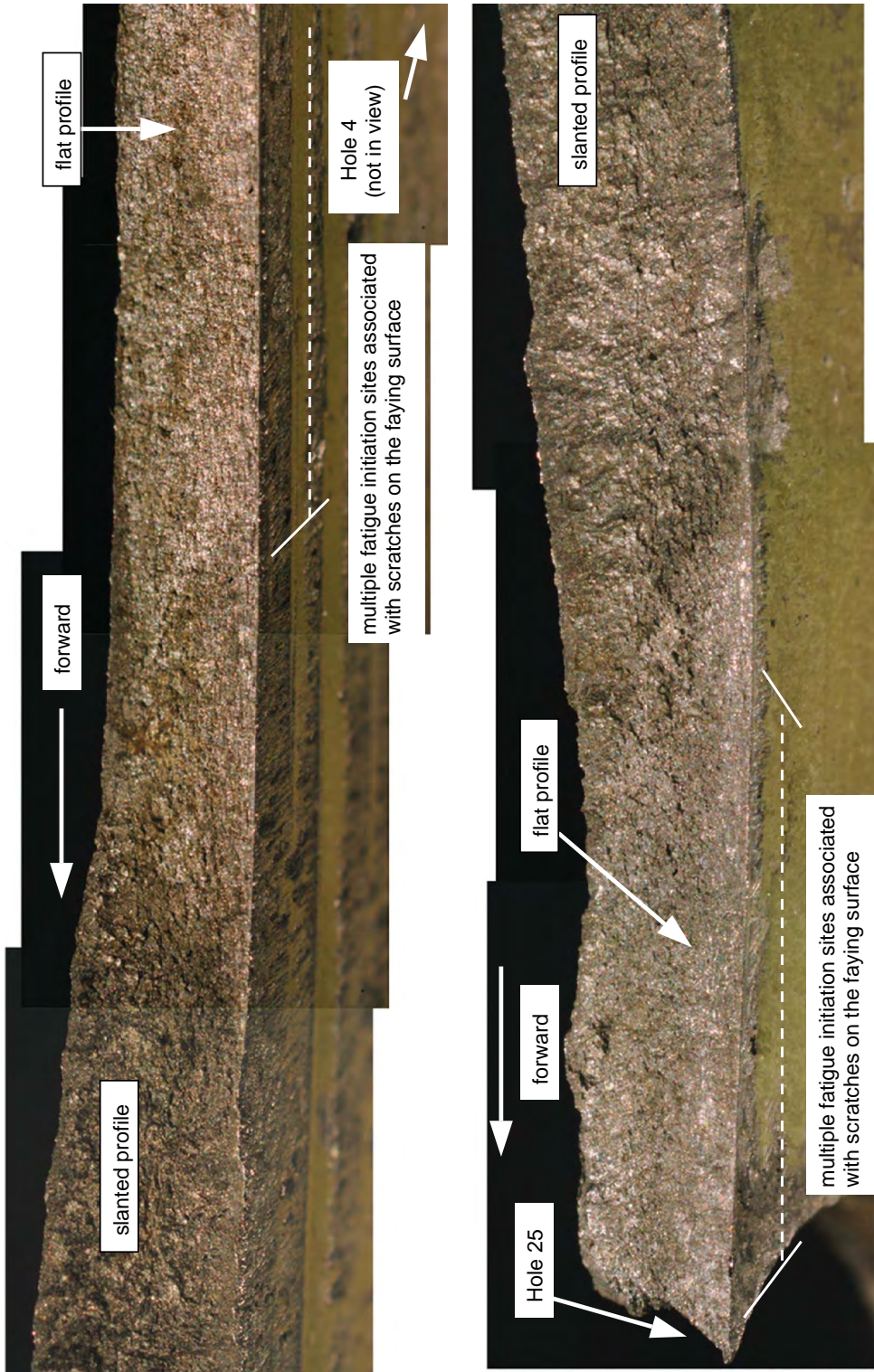

Figure 9, Photographs showing the transition regions from flat fracture profiles to slanted profiles just forward of fastener Hole 4 (top) and Hole 25 (bottom).

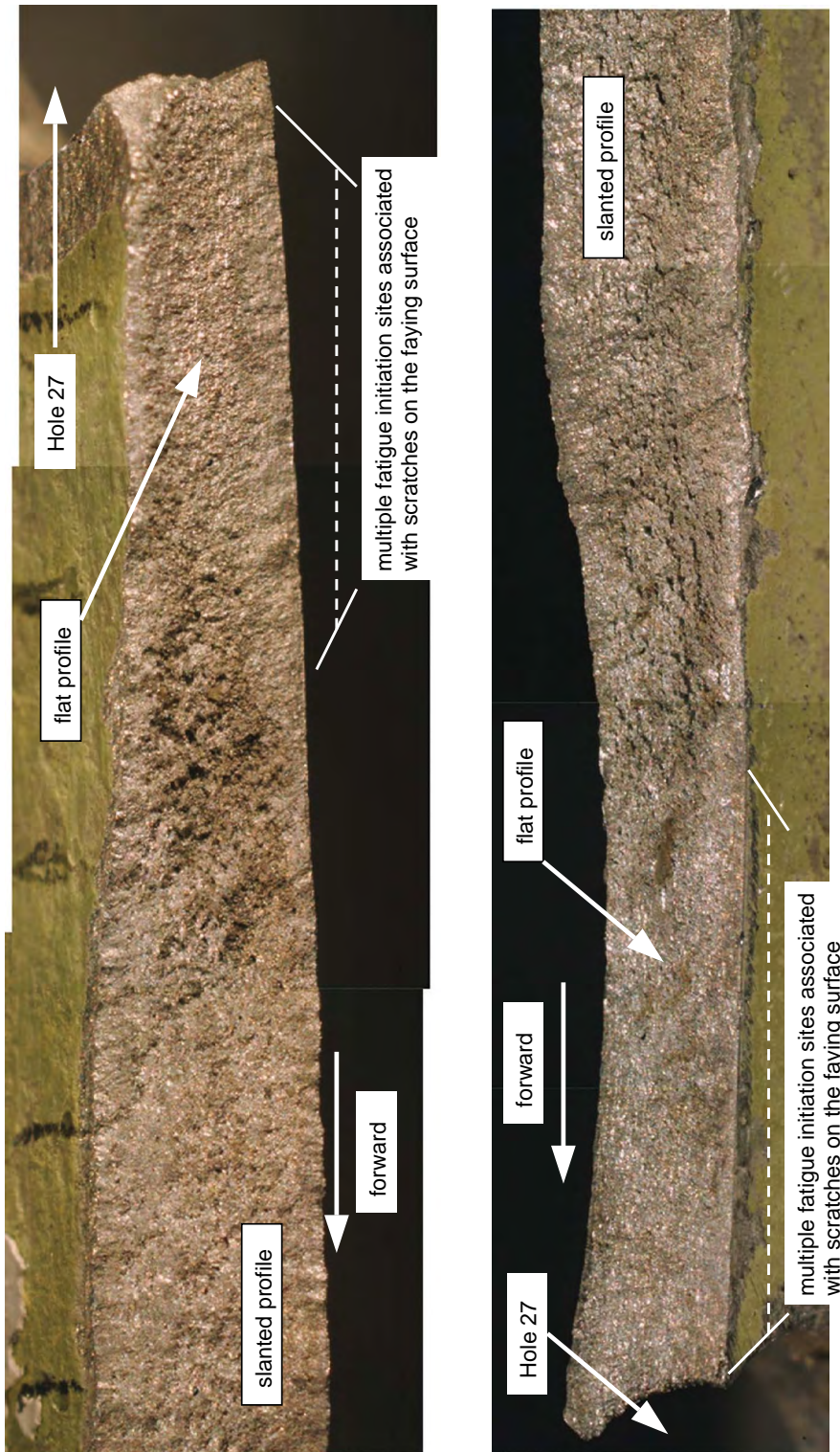

Figure 10, Photographs showing the transition regions from flat fracture profiles to slanted profiles at fastener Hole 27 in the forward direction (top) and the aft direction (bottom).

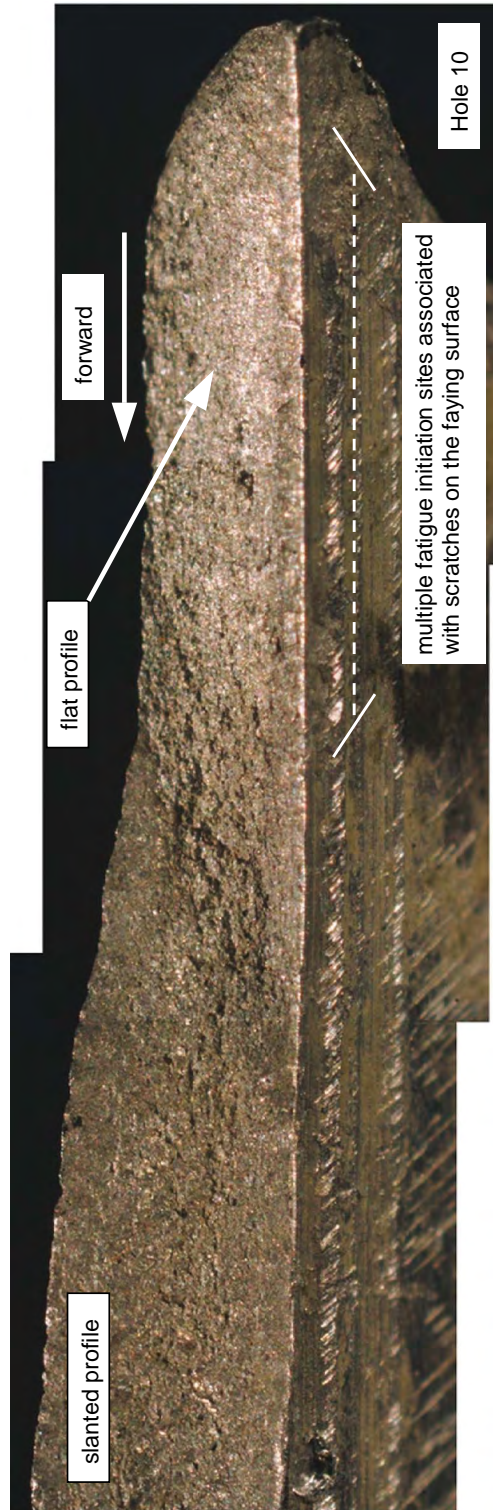

Figure 11, Photograph showing the transition region from a flat fracture profile to a slanted profile at fastener Hole 10 in the forward direction.

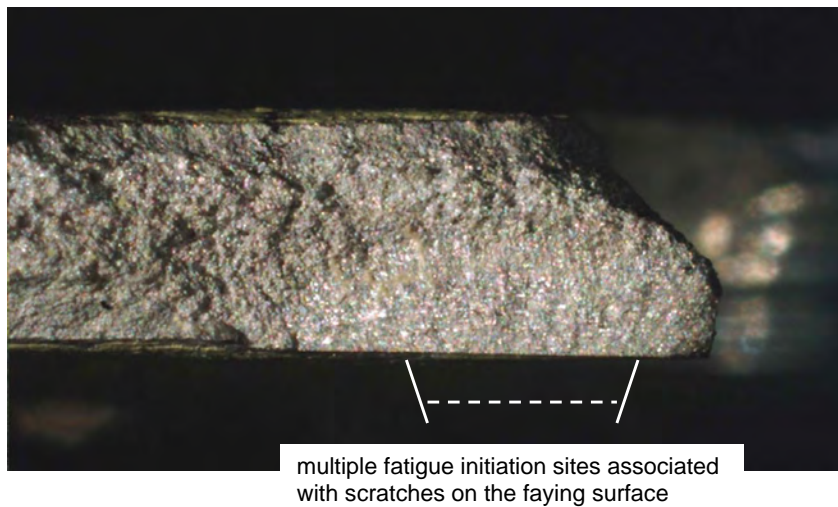
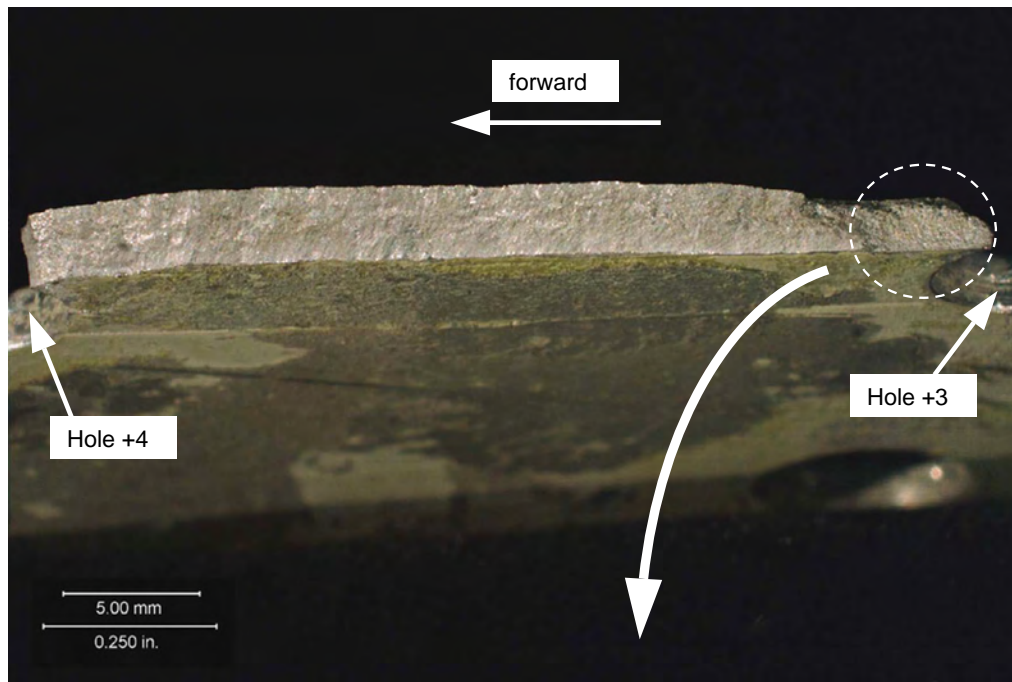

Figure 12, Photographs of the fracture segment extending from Hole +3 to +4 (top), and closer view of the flat profile fatigue region on the forward side of Hole +3 (bottom).

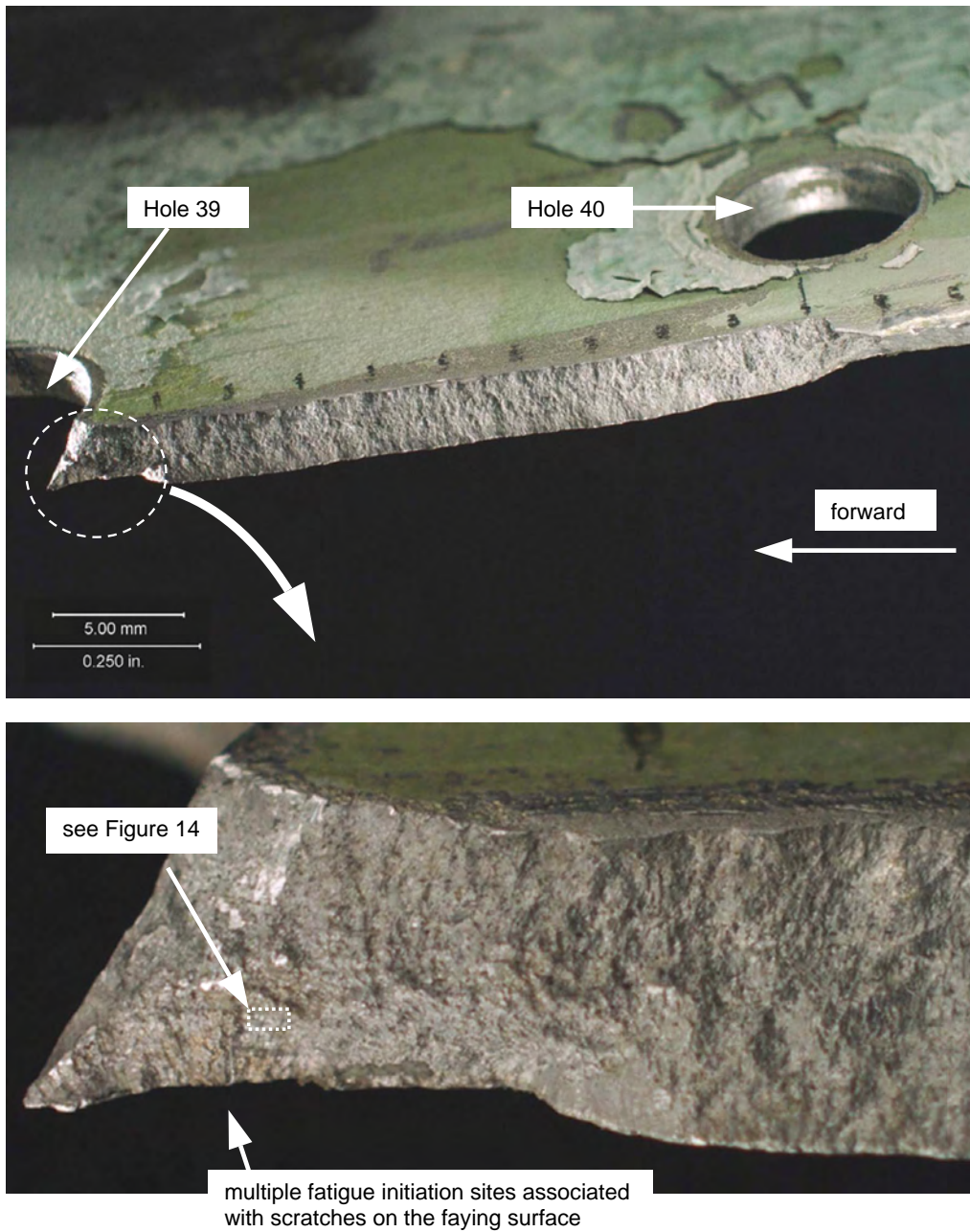

Figure 13, Photographs of the fracture segment extending from Hole 39 to 40 (top), and closer view of the flat profile fatigue region and short transition zone on the aft side of Hole 39 (bottom). SEM photographs showing a dramatic increase in striation spacing near the extent of the flat fracture thumbnail (indicated area) are shown below in Figure 14.

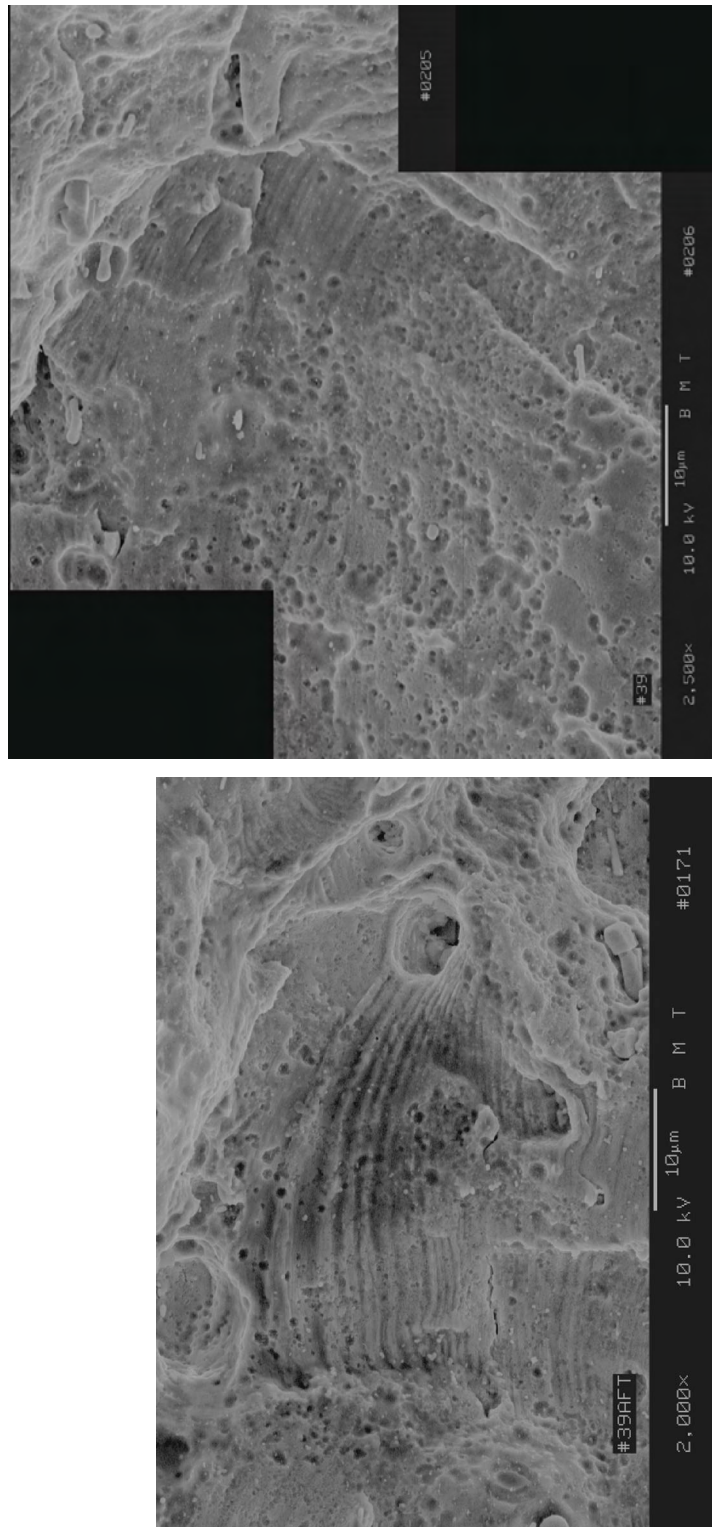

Figure 14, scanning electron microscope photographs showing fatigue striations near the end of the flat profile fracture surface aft of Hole 39. Just beyond these regions, the fracture surface was dominated by a dimpled morphology, indicative of the fracture mechanism of micro-void coalescence, or ductile separation. Severe pitting due to corrosion can also be seen.

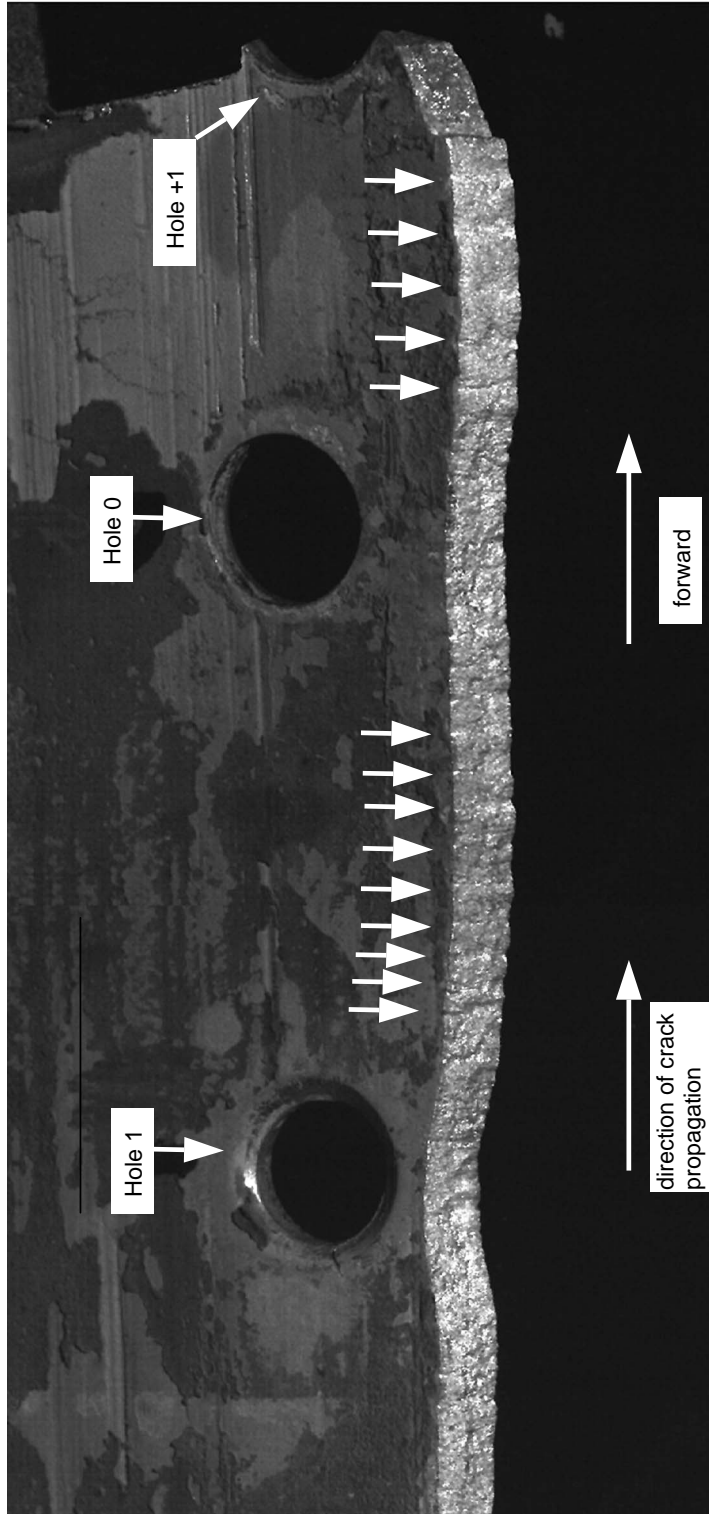

Figure 15, Photograph showing the incremental crack growth indications on the fracture segment from Hole 1 to Hole +1 with two groups of them identified with arrows. This area is just a few inches forward of the flat profile fatigue and transition areas of Hole 4 shown in Figure 9. Note that the regular spacing generally increases as the distance increases from the main cracking system at Holes 4 through 26. These features indicate that the dominant crack was growing at macroscopic rates in a forward direction here when these features were formed, rather than in a through-thickness direction as was the earlier fatigue initiation and propagation mechanism. This point is further exemplified in the following Figure 16.

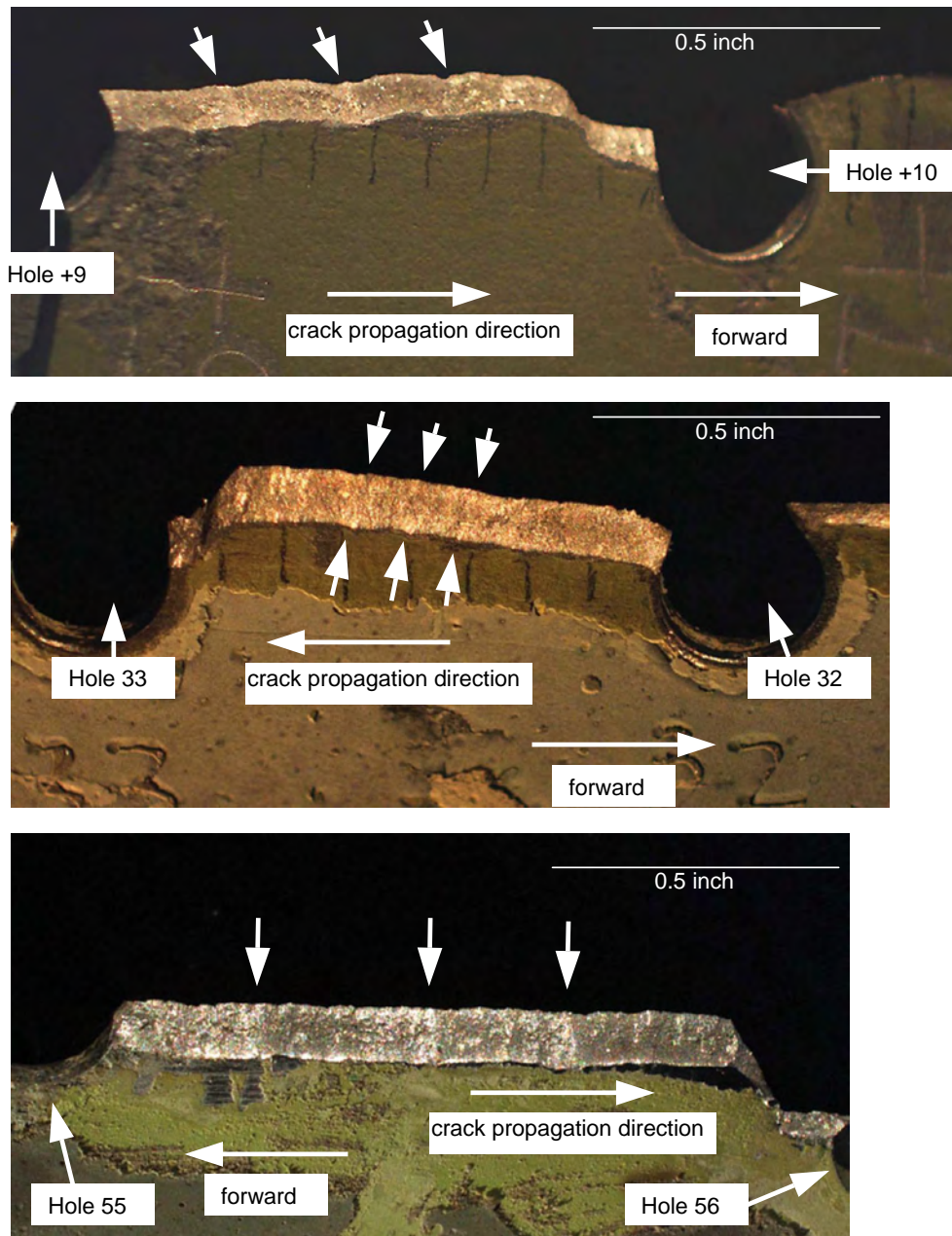

Figure 16, Photographs showing the incremental crack growth indications on the fracture segments between Holes +9 and +10 (top), Holes 32 and 33 (center), and Holes 55 and 56 (bottom).

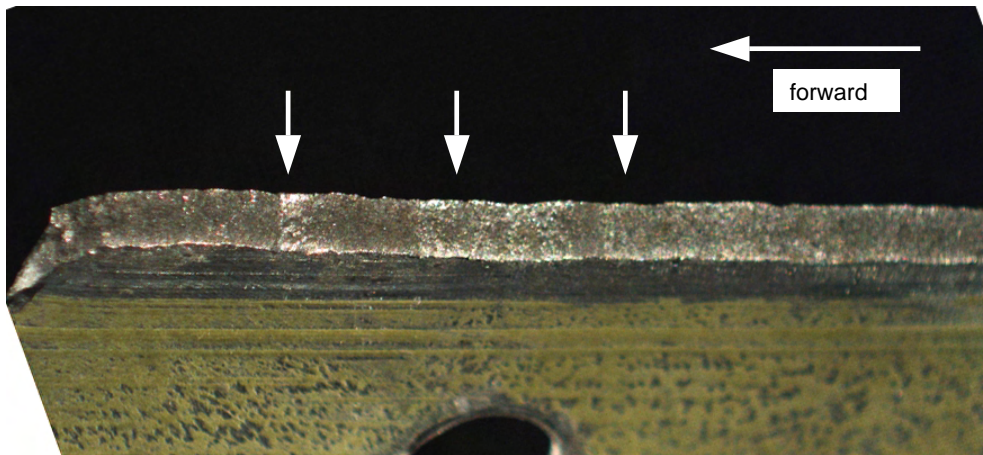

Figure 17, Photograph showing the incremental crack growth indications (arrows) on the fracture segment near Hole 7, which is between the two main fatigue cracking systems at Holes 4 and 5 and Holes 10 through 25.

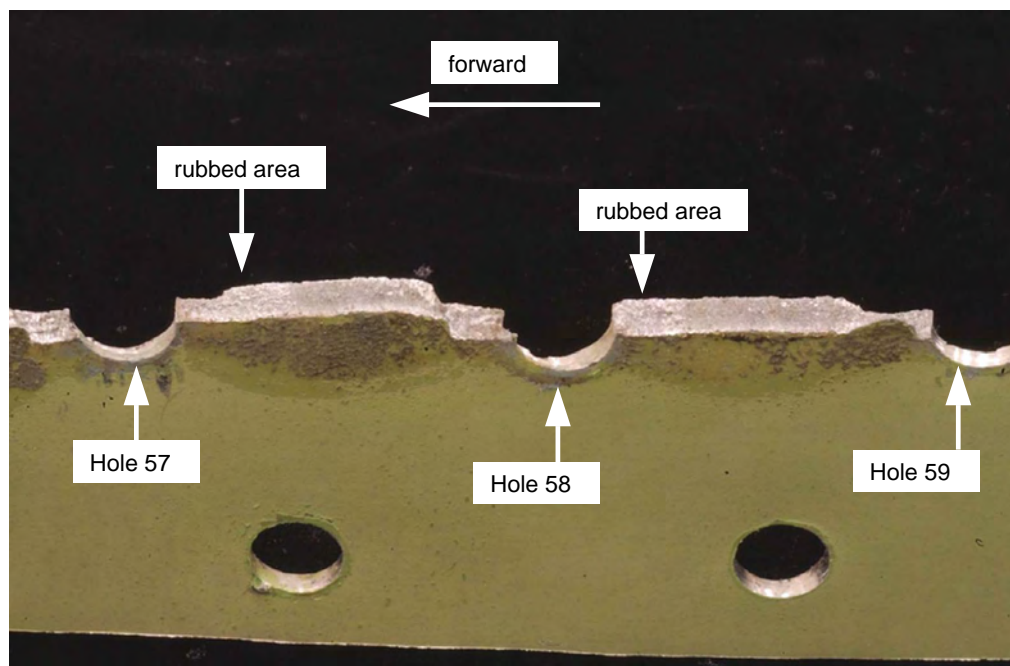

Figure 18, Photograph of the fracture surface at Holes 57, 58, and 59. The shiny areas are indicative of rubbing with the mating fracture surface and appeared consistently forward of this area, but were not present aftward beyond Hole 62.

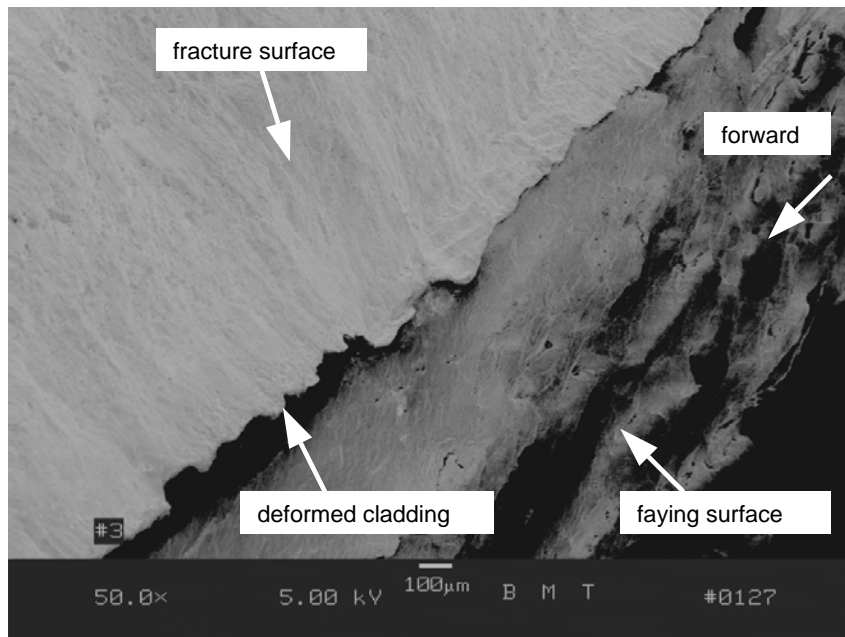

Figure 19, Scanning electron microscope photograph along the edge of the fracture common to the faying surface where the aluminum cladding remained near Hole 3. The fracture surface profile was slanted here. Another example further forward of this area is shown in Figure 20 below. Quasi-stable crack growth beyond these regions allowed cyclic crack closure, causing surface rubbing and compressive deformation of the cladding.

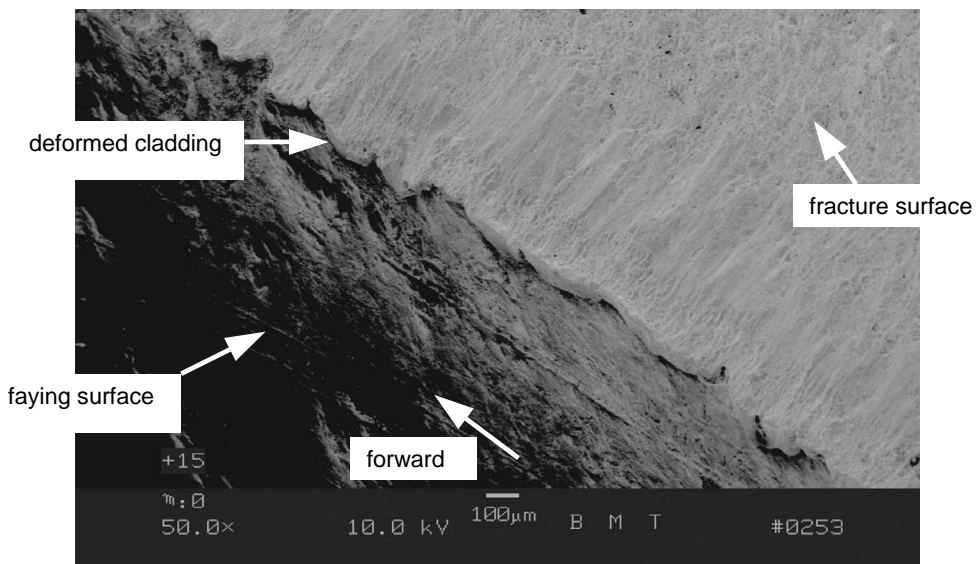

Figure 20, SEM photograph showing the compressive deformation of the cladding just forward of Hole +15.

Rev. A

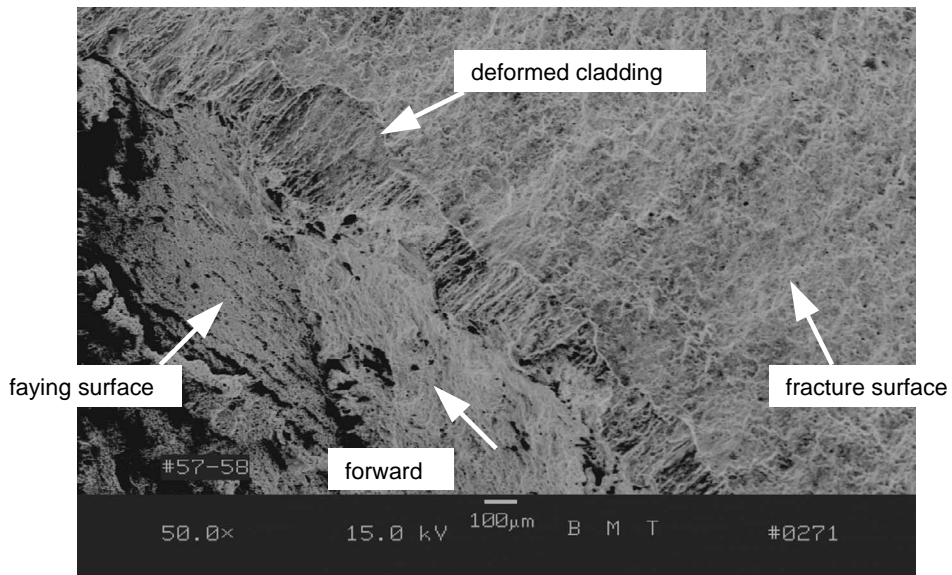

Figure 21, SEM photograph showing the compressive deformation of the cladding between Holes 57 and 58. Note that the degree of compressive damage is less severe than that observed closer to the main cracking system, Figure 19 for example. Fracture surfaces near the extreme extent of pre-existing cracking would have experienced few repetitive crack closures.

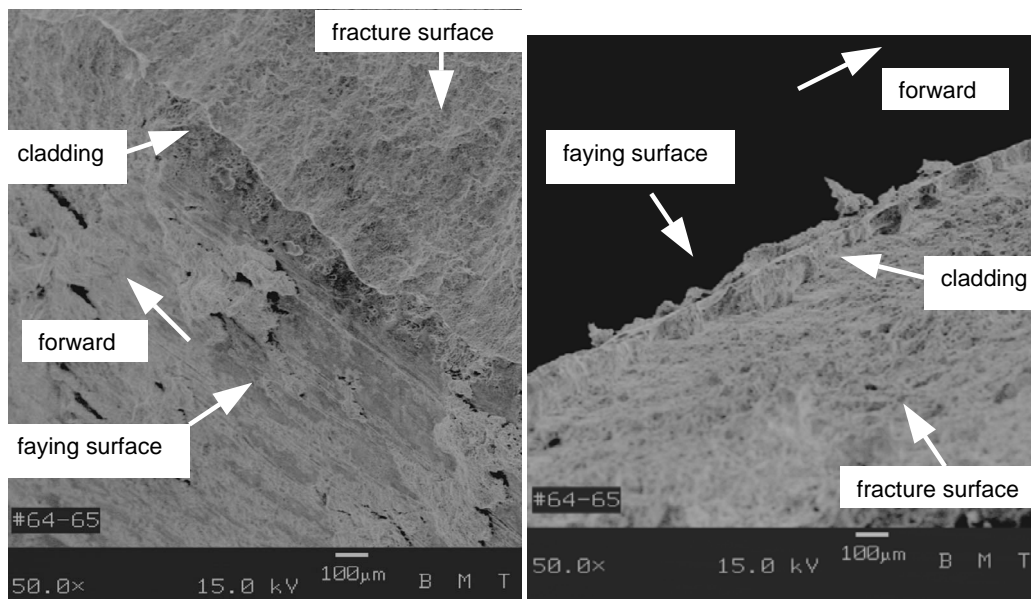

Figure 22, opposing angle SEM photographs of the fracture segment between Holes 64 and 65 showing the cladding on the faying surface retaining its upward profile from the necking process during ultimate tensile separation without subsequent crack closure.

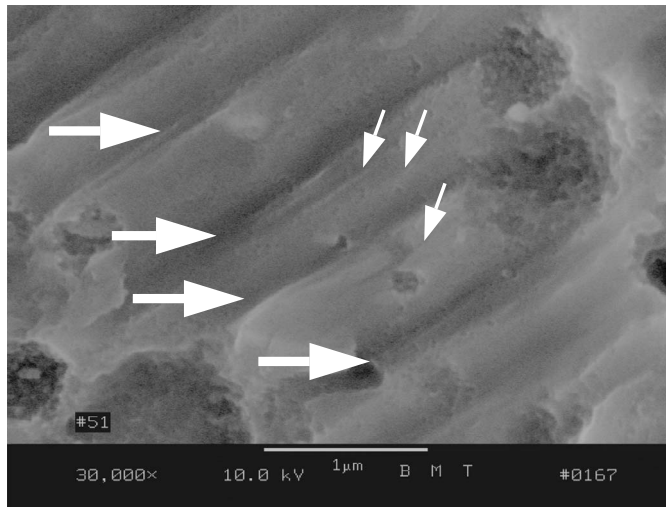

Figure 23, SEM photograph showing minor striation-like features (indicated with smaller arrows), which were also observed during examination at the Chung Shan Institute of Science and Technology. Such features are not uncommon and were ignored for striation counting purposes. The striations corresponding to flight cycles, and used for estimating growth rates are indicated with the large arrows.

TABLE VII
Striation Count Results

Location Title	Location of Traverse	Total Cycles (Point)	Total Cycles (Ext.)
Hole # +3	.15 inch fwd of hole centerline	8,000	11,000
Hole # 5	Centerline of hole	6,700	9,400
Hole # 12	.10 inch aft of hole centerline	1,600	2,800
Hole # 13	Centerline of hole	5,400	6,300
Hole # 13	.55 inch aft of hole centerline	2,000	2,400
Hole # 15	.10 inch aft of hole centerline	3,100	5,800
Hole # 16-17	.50 inch aft of hole centerline	2,600	3,300
Hole # 17-18	.45 inch aft of hole centerline	1,300	2,400
Hole # 19	.10 inch fwd of hole centerline	6,400	9,000
Hole # 21	Centerline of hole	8,300	10,200
Hole # 23	.15 inch aft of hole centerline	9,100	10,900
Hole # 25	.20 inch aft of hole centerline	1,700	4,000
Hole # 27 Fwd	.15 inch aft of hole centerline	5,500	7,700

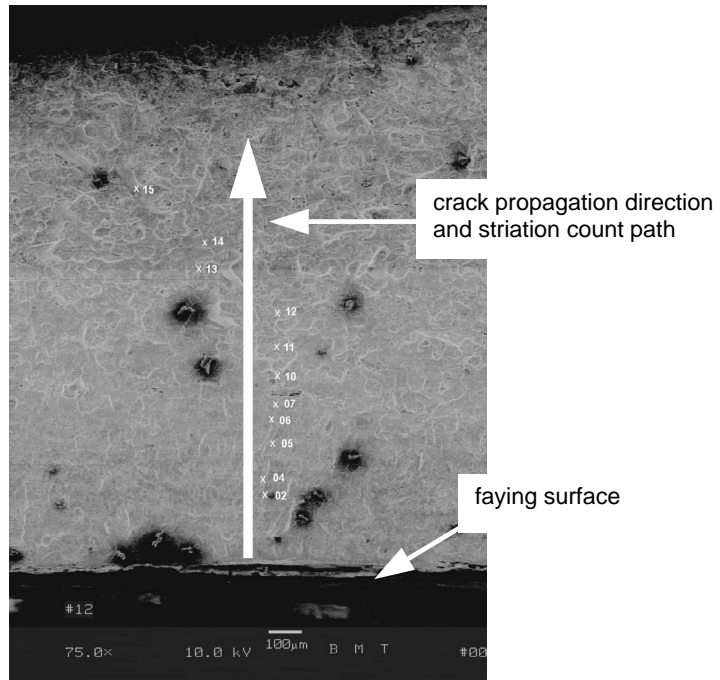

Figure 24, SEM photograph showing the locations through the skin thickness that were sampled for crack growth rate at Hole 12. The approach was repeated for other through-thickness areas

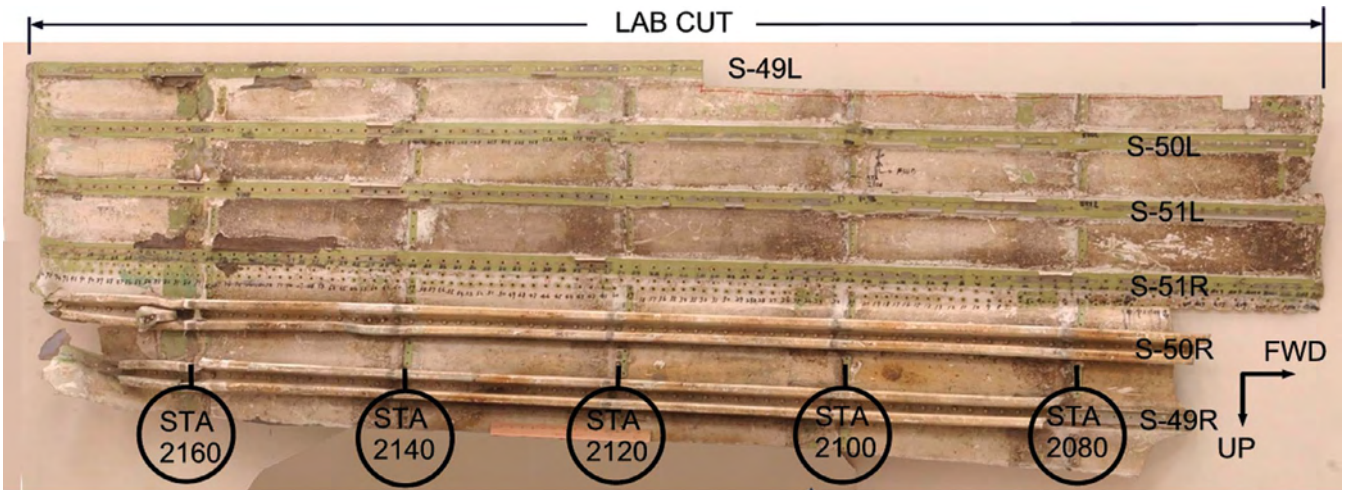

FIGURE 25. AS RECEIVED ITEM 640 CI SKIN INBOARD SURFACE- The S-49L fracture segment was removed at the CSIST during the initial examination.

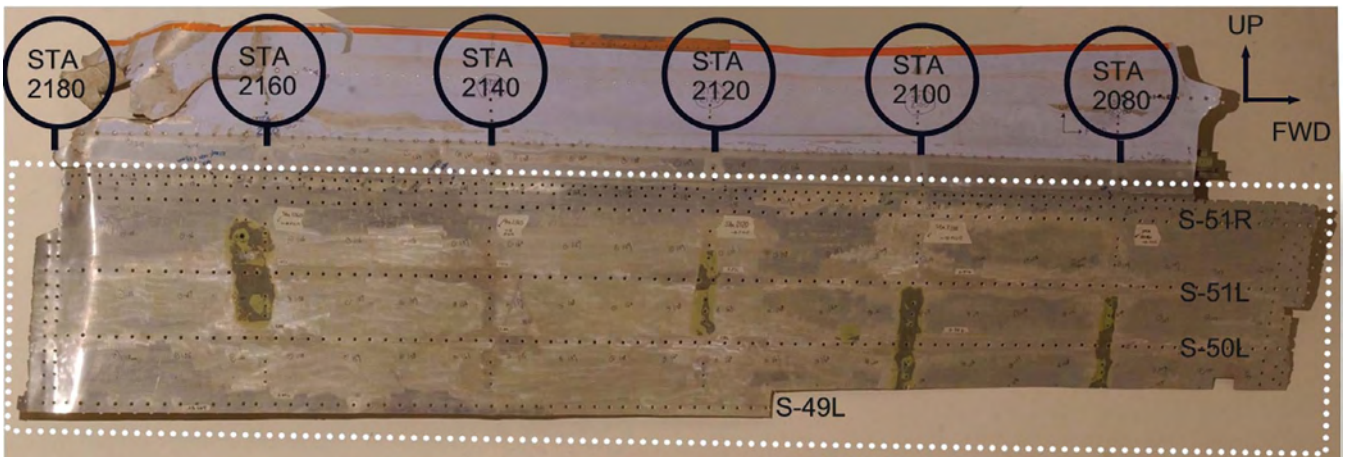

FIGURE 26. AS RECEIVED ITEM 640 C1 SKIN OUTBOARD SURFACE – The approximate location of the repair doubler is shown with dotted lines. Protective finishes were removed from the repair faying surface at the CSIST.

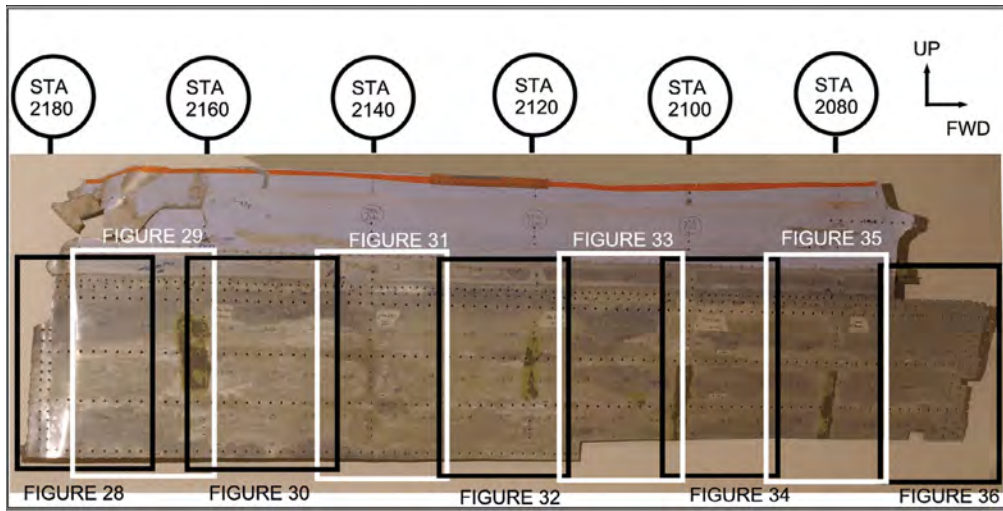

FIGURE 27. SCRATCH PHOTOGRAPH LEGEND – This illustration identifies the location of following photographs that document scratch features observed on the skin repair faying surface. Scratches are fore/aft in orientation and characteristic of a tail strike event.

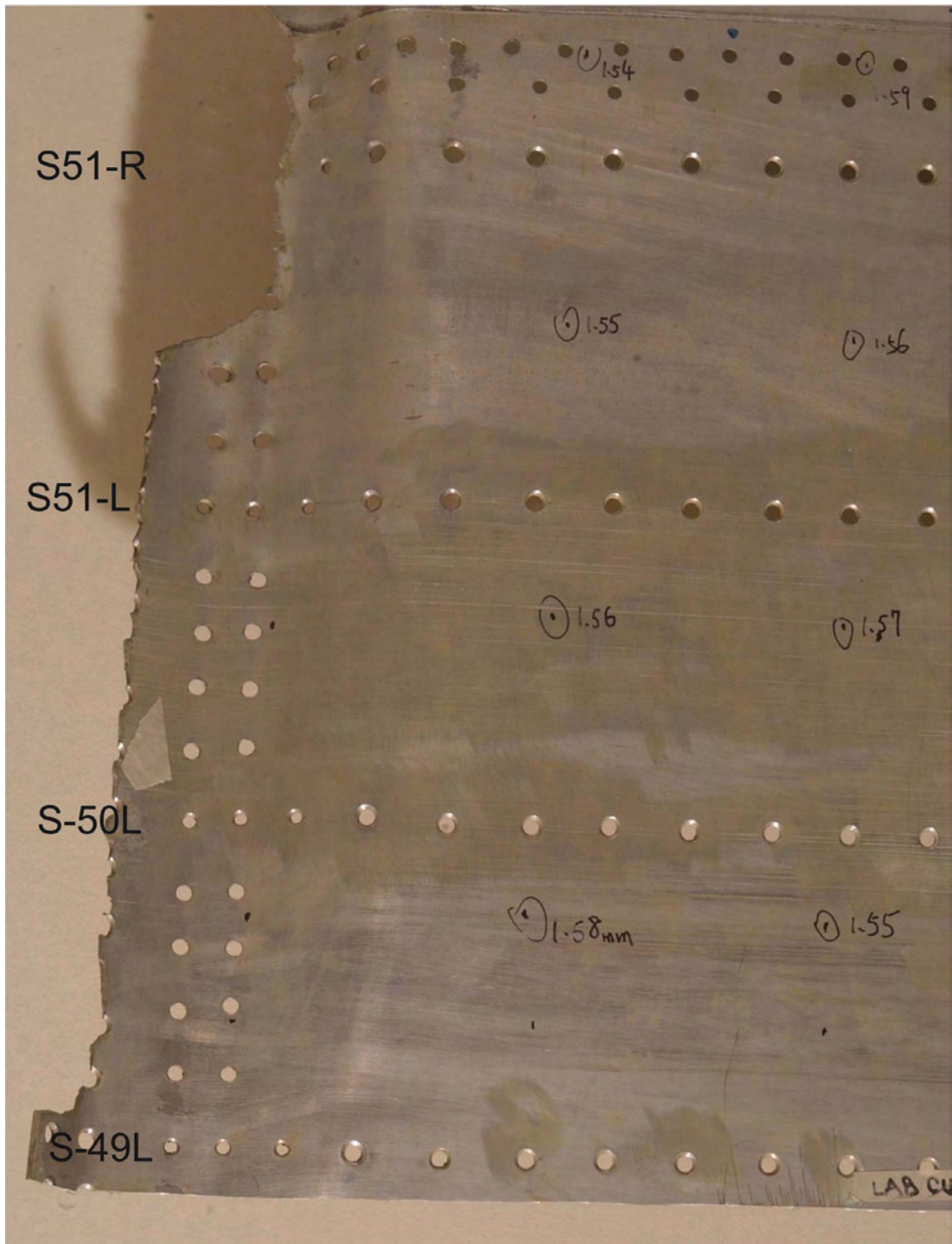

FIGURE 28 – EXTENT OF DAMAGE CONSISTENT WITH A TAIL STRIKE – Scratches may be noted at S-50L and S-51L. Numerical information on skin are results of thickness measurements at the CSIST. Scratch severity increases as you move forward on the panel as shown in the following photographs.



FIGURE 29. EXTENT OF DAMAGE CONSISTENT WITH A TAIL STRIKE – Scratches may be noted at S-50L and S-51L. Scratches may also be noted at the shear tie between S-49L and S-50L.

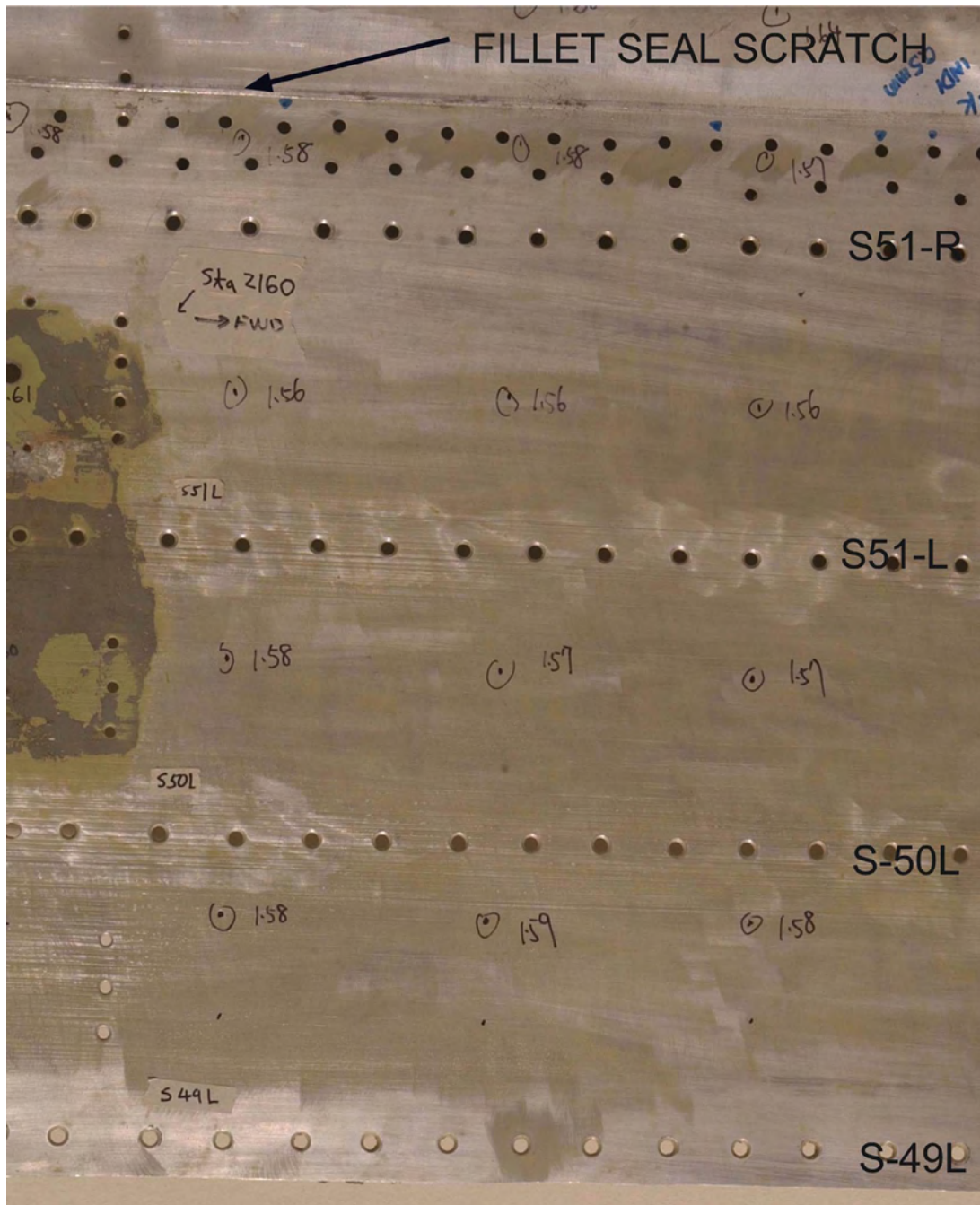

FIGURE 30. EXTENT OF DAMAGE CONSISTENT WITH A TAIL STRIKE - Note that minimal damage occurs on the right hand side of the repair area. Scratching in the doubler fillet seal area may also be seen in this photo.

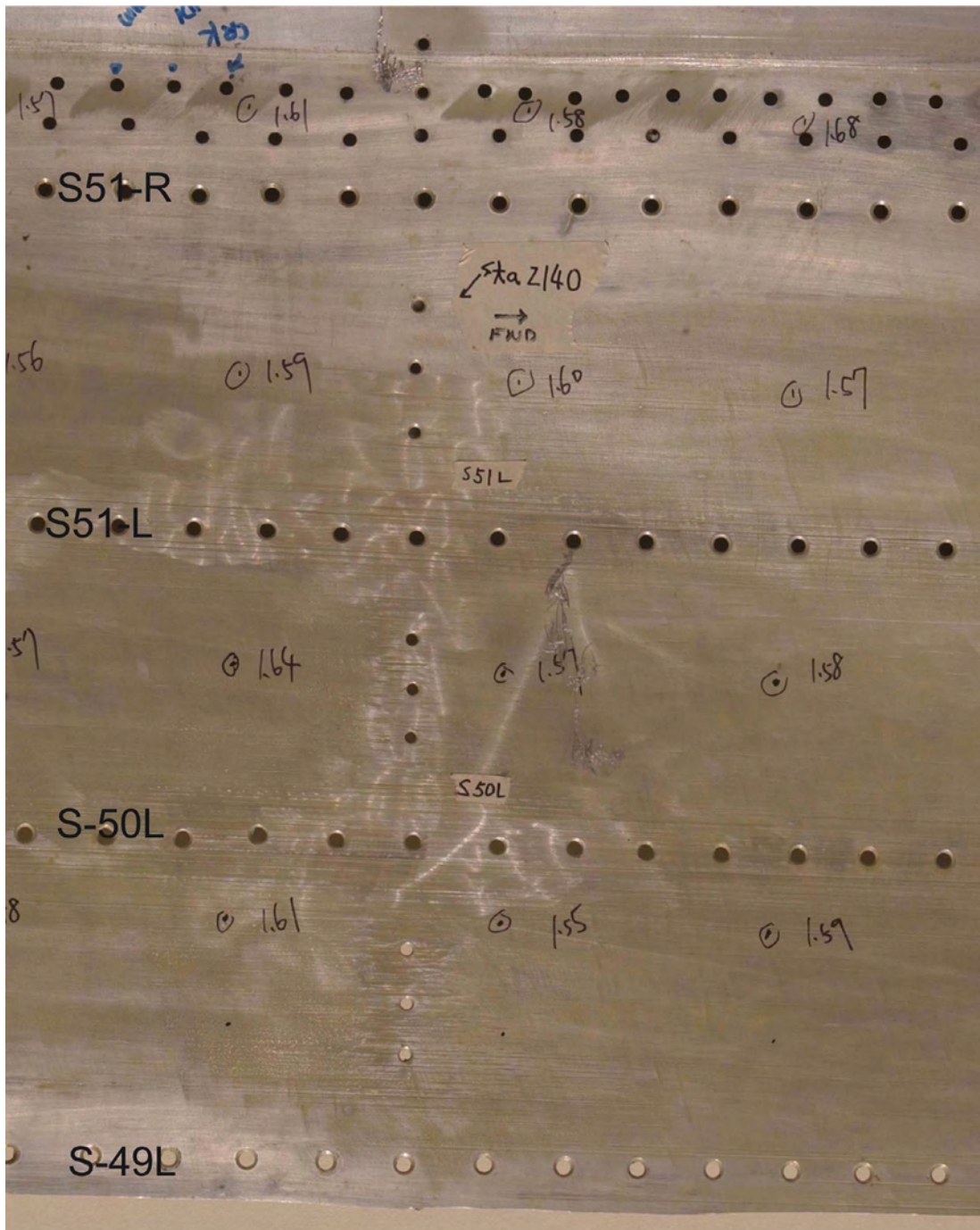

FIGURE 31. EXTENT OF DAMAGE CONSISTENT WITH A TAIL STRIKE

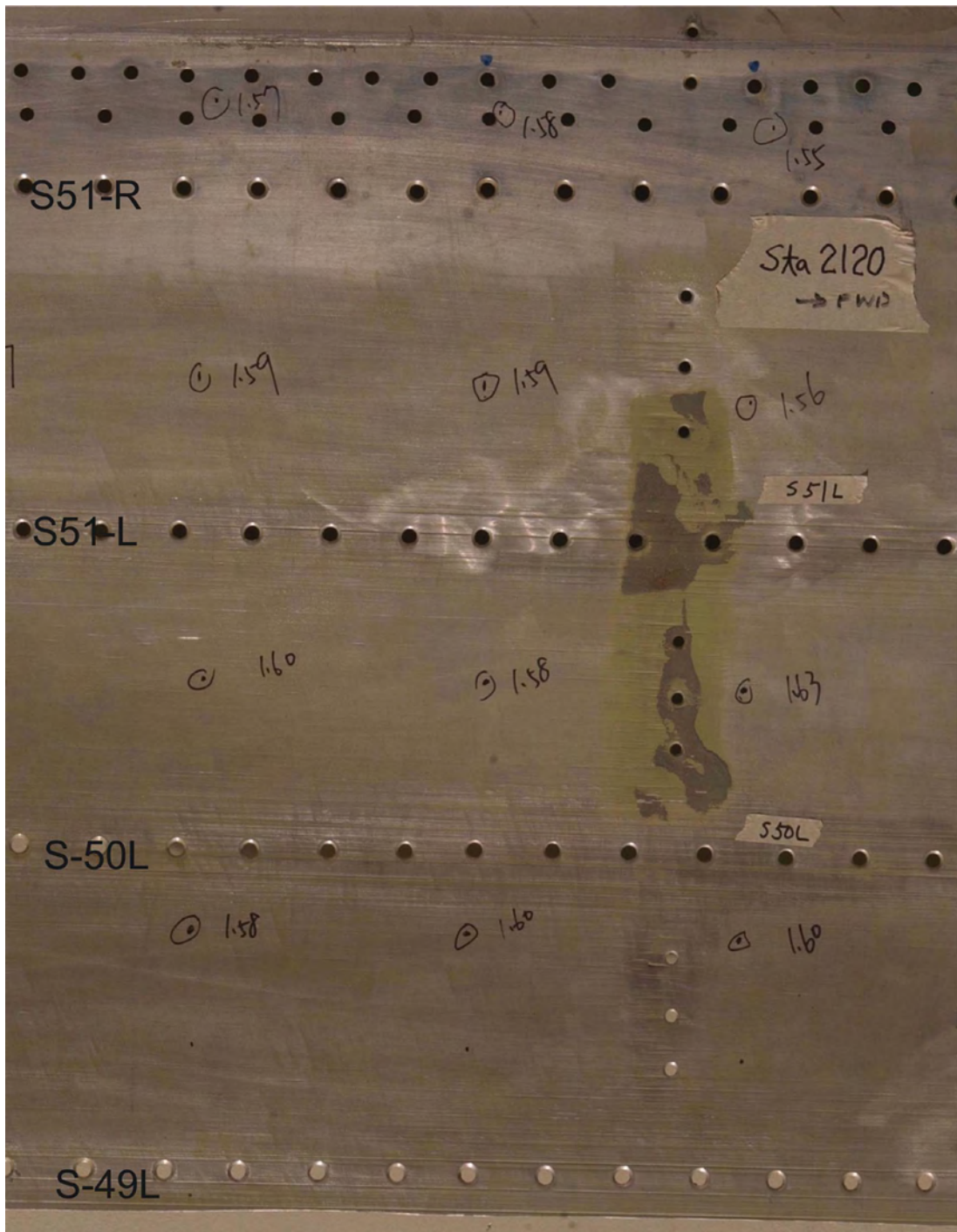

FIGURE 32. EXTENT OF DAMAGE CONSISTENT WITH A TAIL STRIKE – Deep scratches can be noted at S-49L, S-50L, AND S-51L.

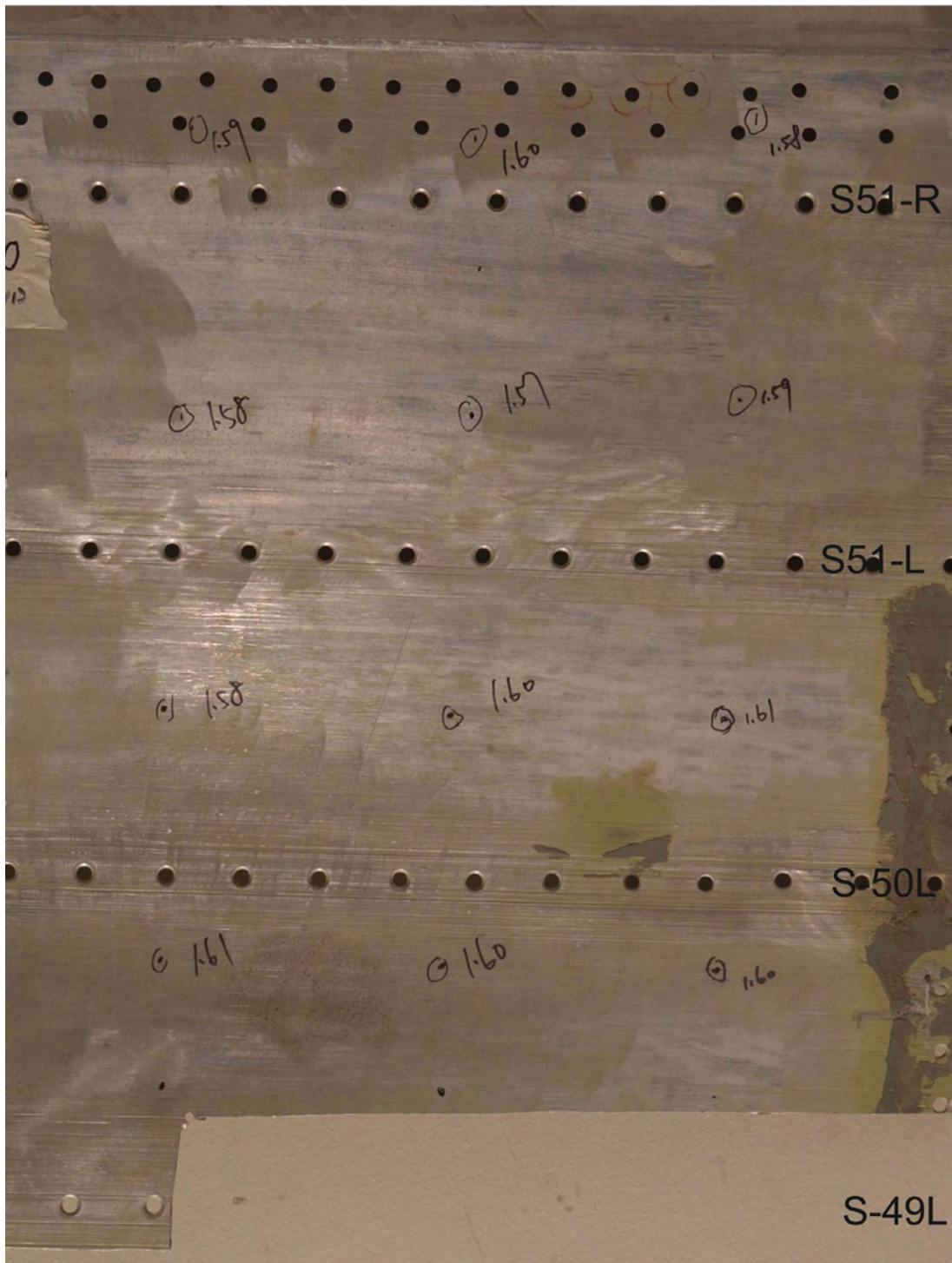

FIGURE 33. EXTENT OF DAMAGE CONSISTENT WITH A TAIL STRIKE



FIGURE 34. EXTENT OF DAMAGE CONSISTENT WITH A TAIL STRIKE

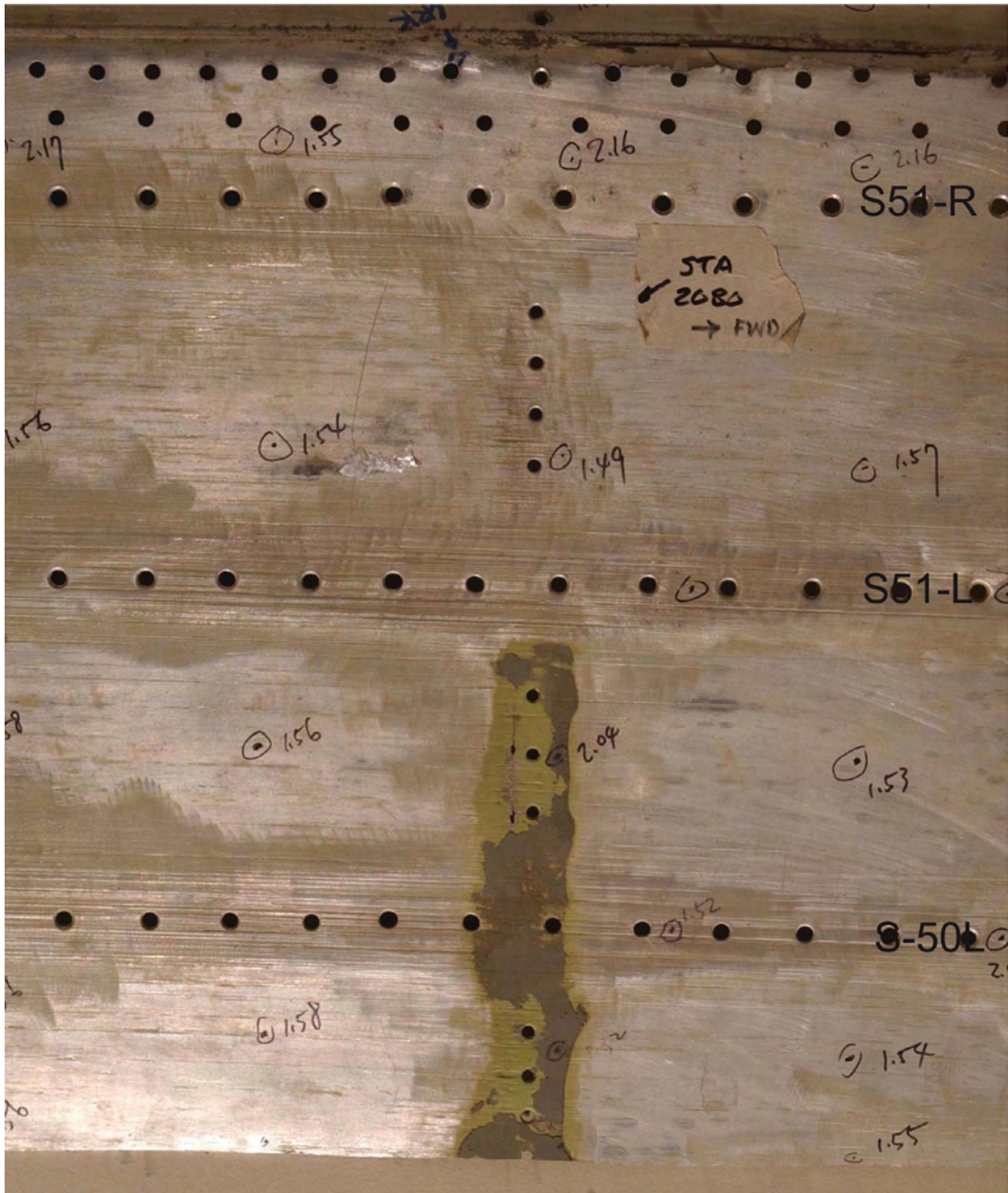

FIGURE 35. EXTENT OF DAMAGE CONSISTENT WITH A TAIL STRIKE – Note the severity of damage in this photo.

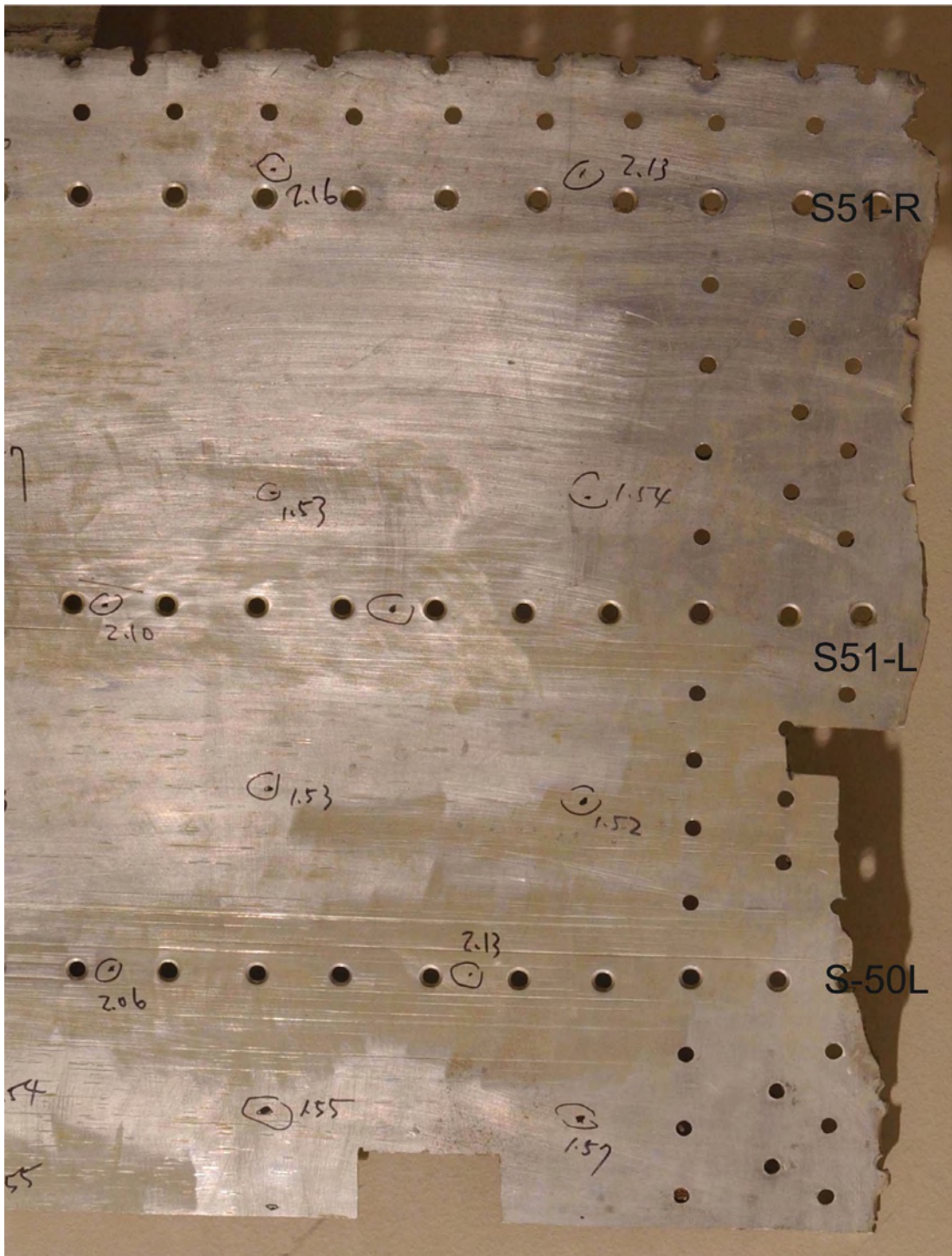

FIGURE 36. EXTENT OF DAMAGE CONSISTENT WITH A TAIL STRIKE

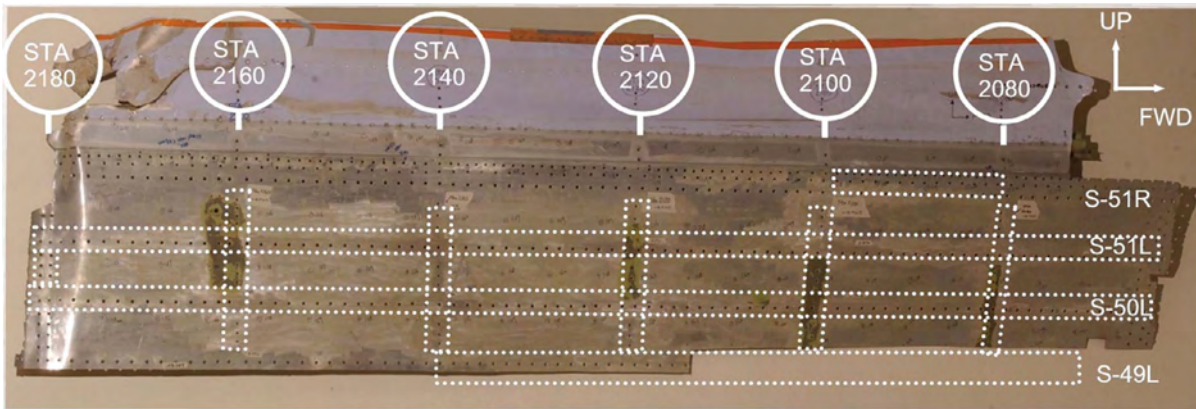

FIGURE 37. AREAS OF MOST SEVERE SKIN DAMAGE – Scratch severity was greatest in the left hand/forward area of the skin.

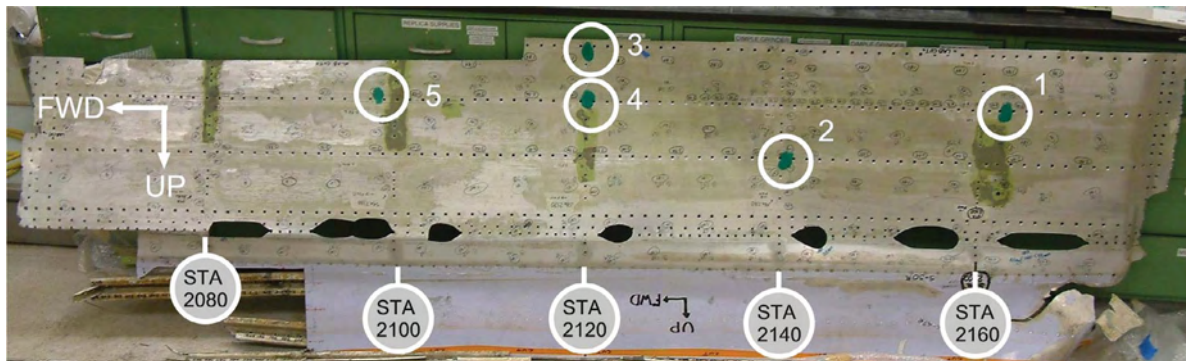

FIGURE 38. LOCATION OF SCRATCH REPLICATION AREAS

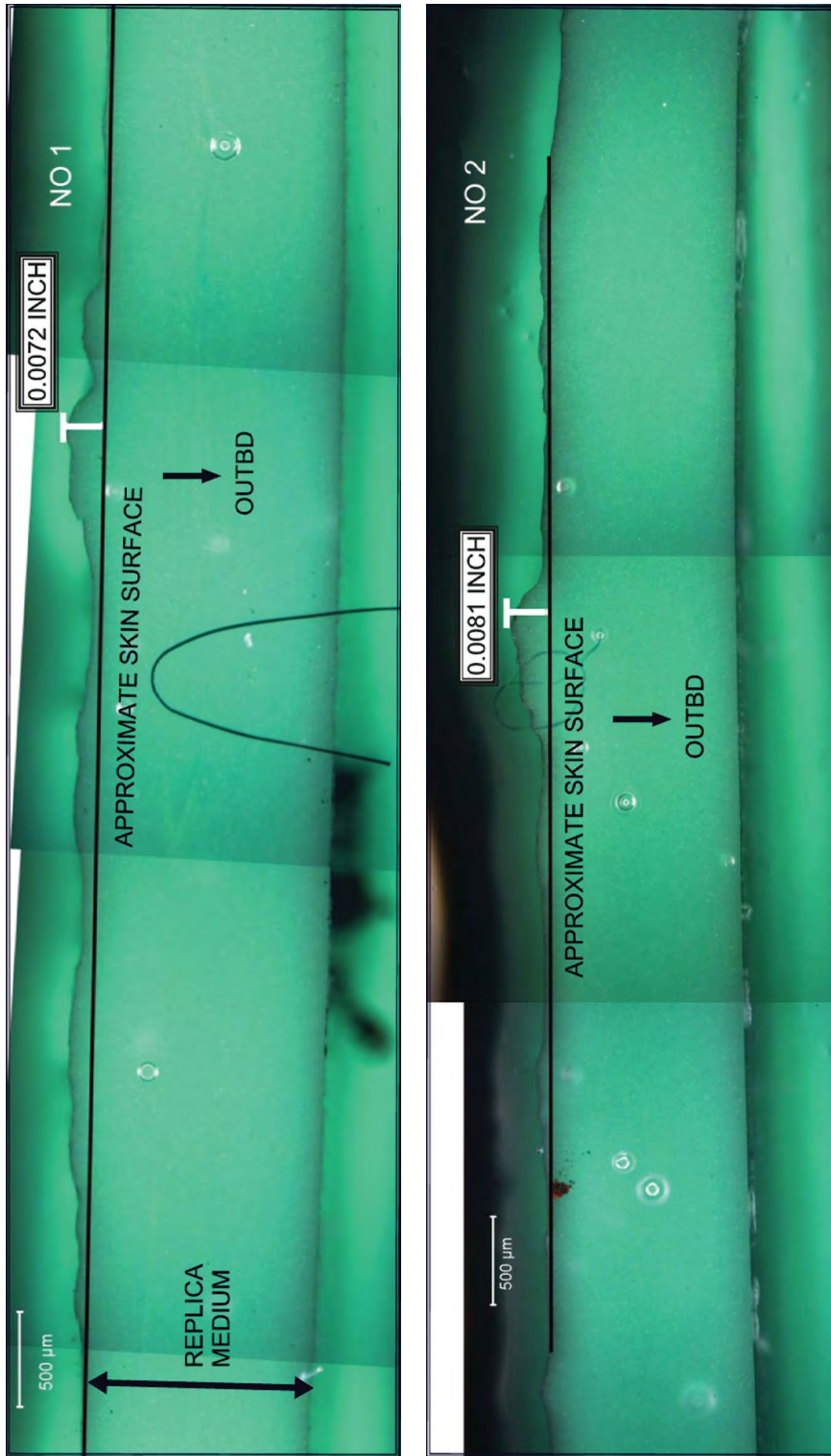

FIGURE 39. SCRATCH PROFILE COMPOSITE PHOTOGRAPHS – The replication medium creates a “positive” of the skin scratches. Scratch features of replica locations 1 and 2 are shown above.

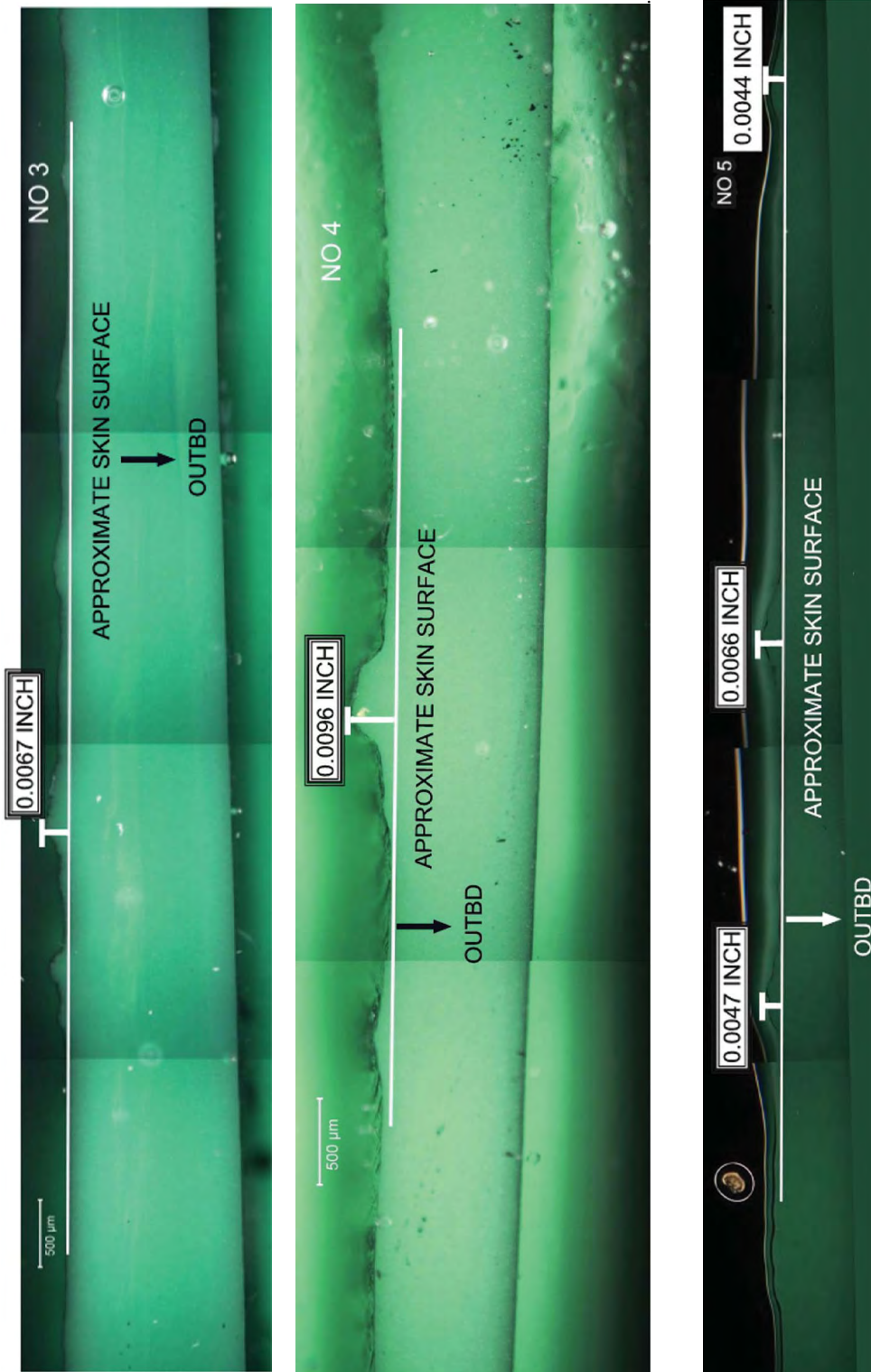

FIGURE 40. SCRATCH PROFILE COMPOSITE PHOTOGRAPHS – Shown above are replicas from locations 3,4, and 5. Location 4 presented the deepest scratch found using this technique.

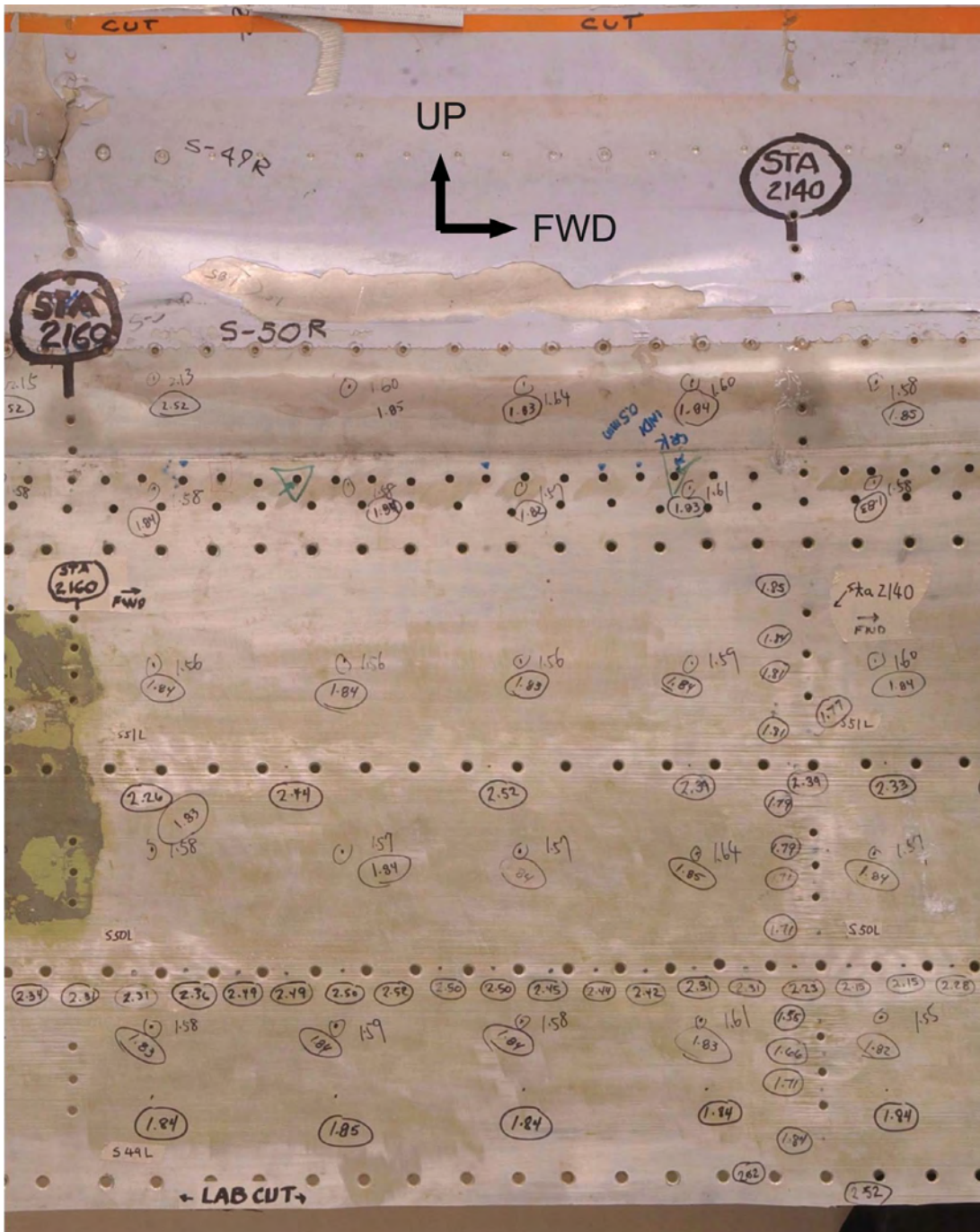

Figure 42. SKIN THICKNESS MEASUREMENTS - All measurements are in millimeters. Circled values were performed at Boeing.

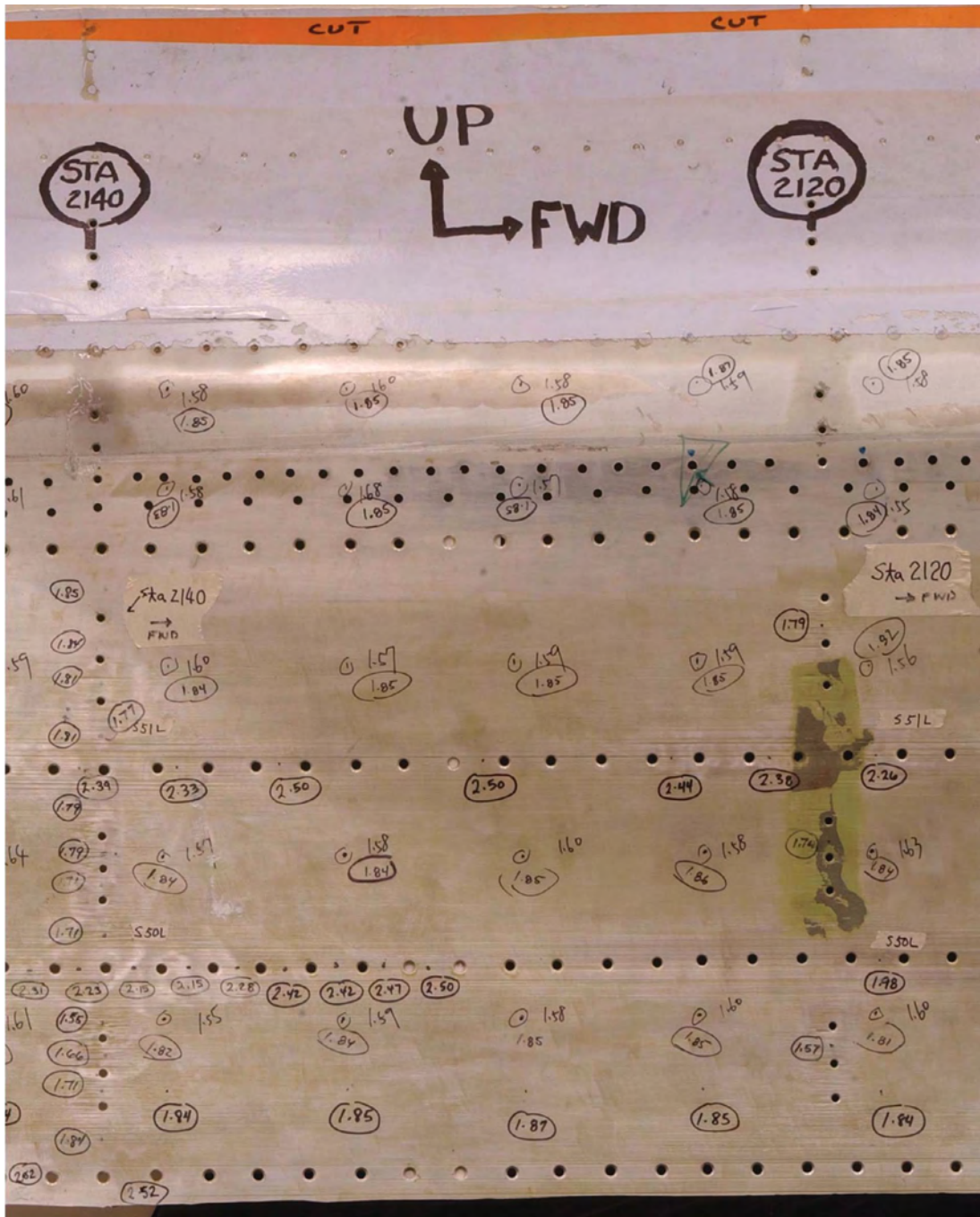

Figure 43. SKIN THICKNESS MEASUREMENTS - All measurements are in millimeters. Circled values were performed at Boeing.

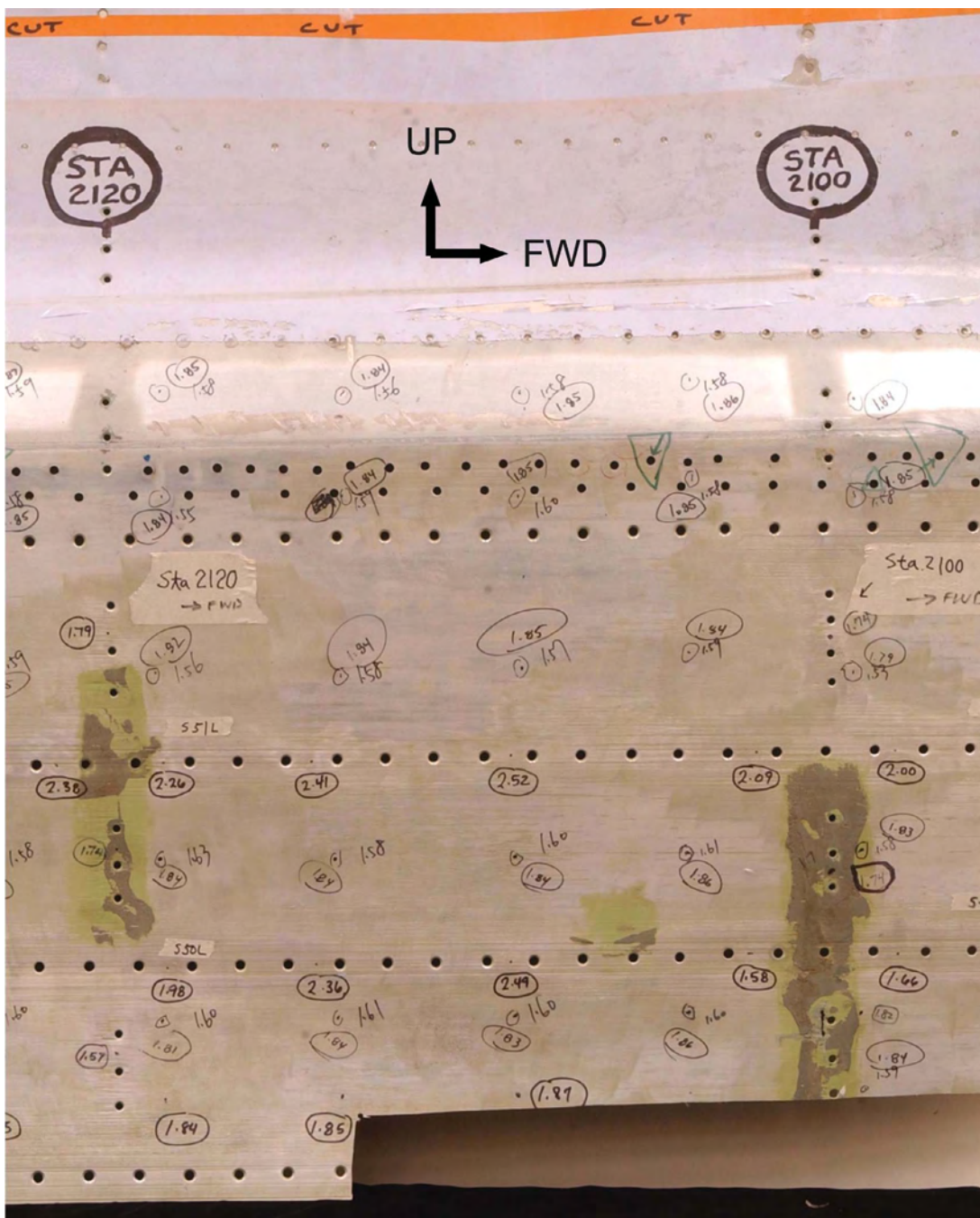

Figure 44. SKIN THICKNESS MEASUREMENTS - All measurements are in millimeters. Circled values were performed at Boeing.

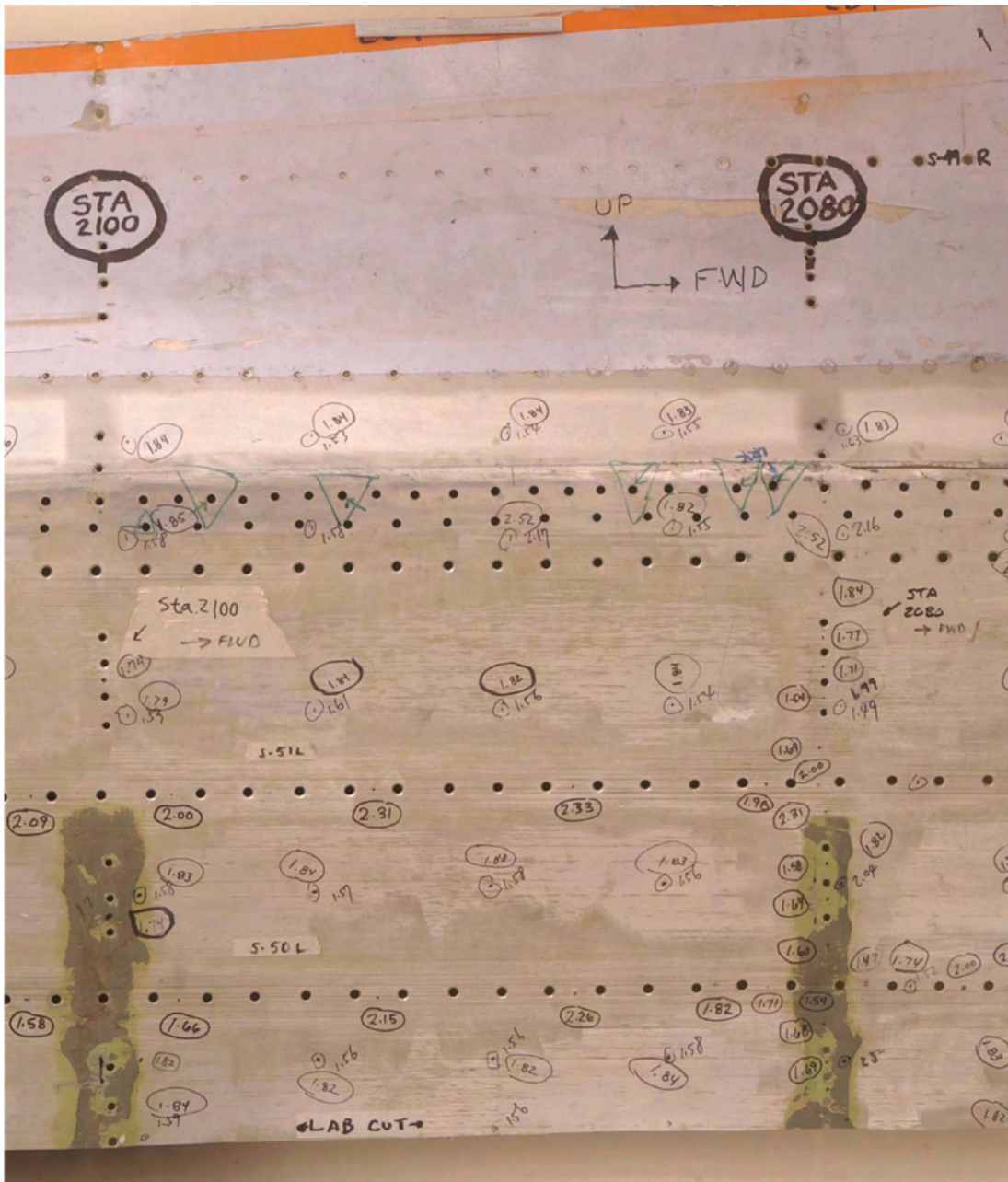

Figure 45. SKIN THICKNESS MEASUREMENTS - All measurements are in millimeters. Circled values were performed at Boeing.

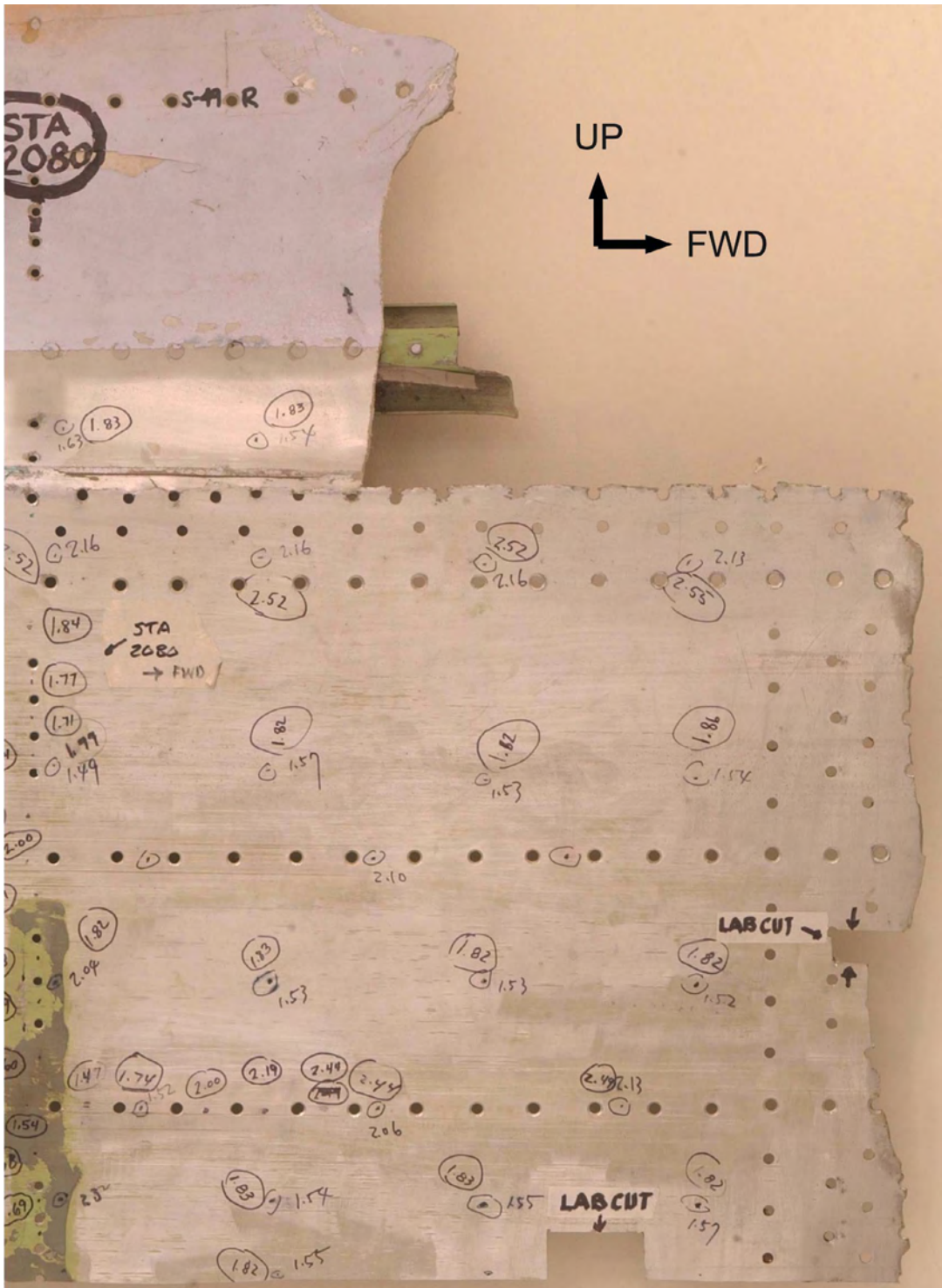
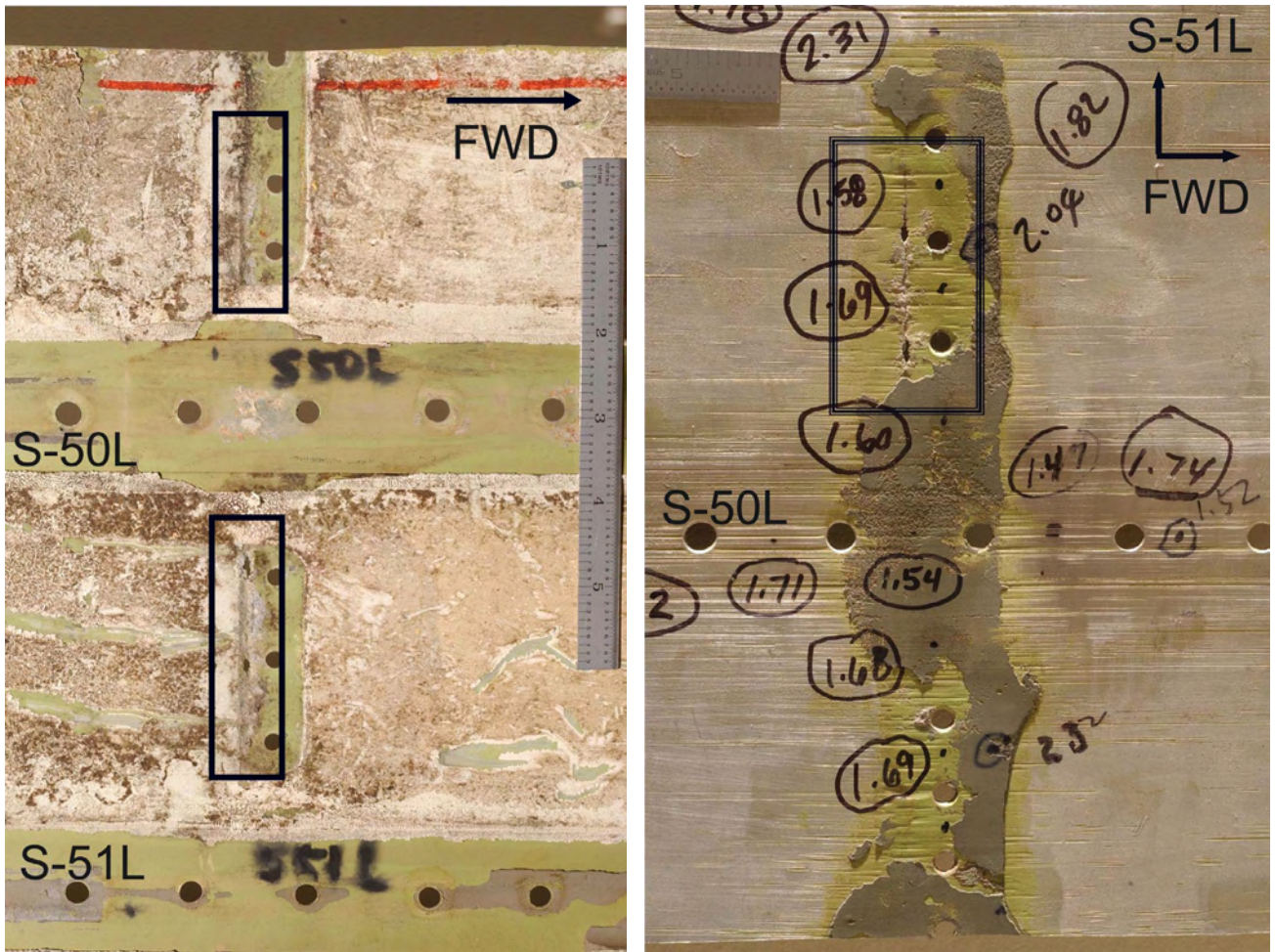

Figure 46. SKIN THICKNESS MEASUREMENTS - All measurements are in millimeters. Circled values were performed at Boeing.



SKIN INBOARD SURFACE

SKIN REPAIR FAYING SURFACE

Figure 47. SKIN CORROSION FEATURES AT STA 2080 - Areas of corrosion are identified with rectangles above. Corrosion penetrated completely through the skin thickness at the shear tie located between S-50L and S-51L.

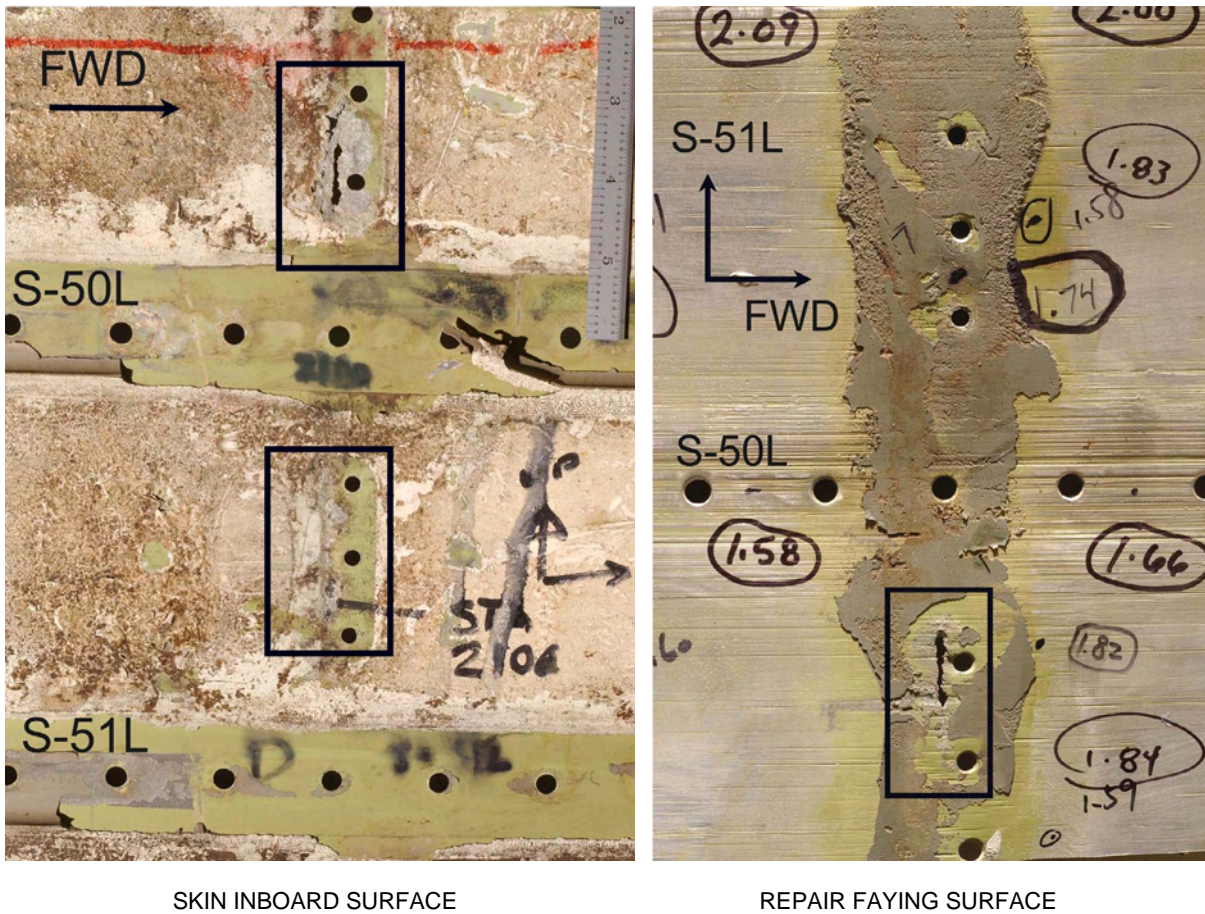

Figure 48. SKIN CORROSION FEATURES AT STA 2100 - Areas of corrosion are highlighted with rectangles. Corrosion penetrated completely through the skin thickness between S-49L and S-50L.

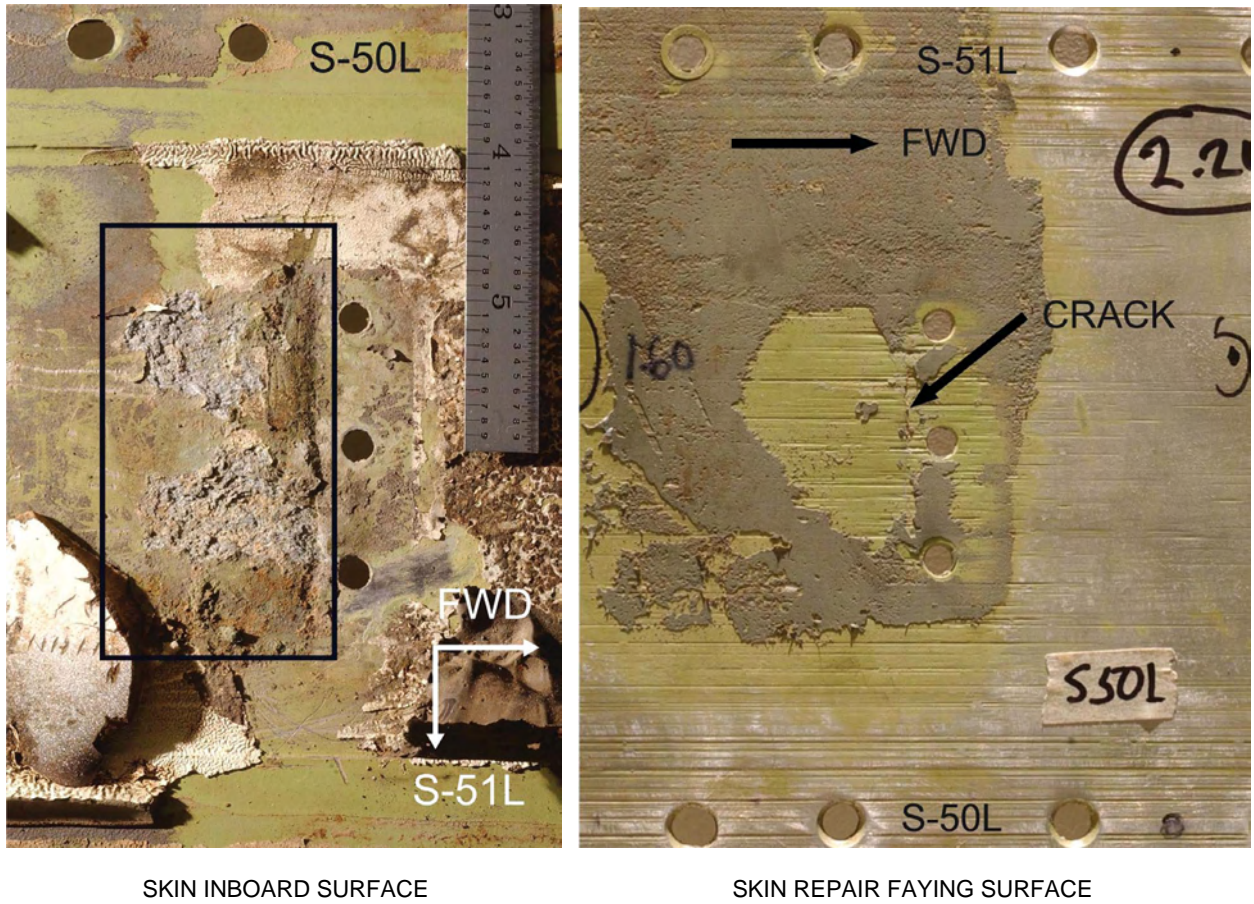

Figure 49. CORROSION FEATURES AT STA 2160, INBOARD SURFACE - The area of corrosion is identified with a rectangle above. A crack noted on the skin faying surface may have been the result of exfoliation corrosion penetrating from the skin inboard surface.

Table VIII

Item 640 C1 skin inboard surface corrosion details

STA	STRINGER BAY	CORROSION THROUGH SKIN THICKNESS	APPROXIMATE AREA (INCH ²)
2080	49L-50L	NO	0.24
2080	50L-51L	YES	0.44
2100	49L-50L	YES	1.44
2100	50L-51L	NO	0.64
2160	50L-51L	YES	2.28

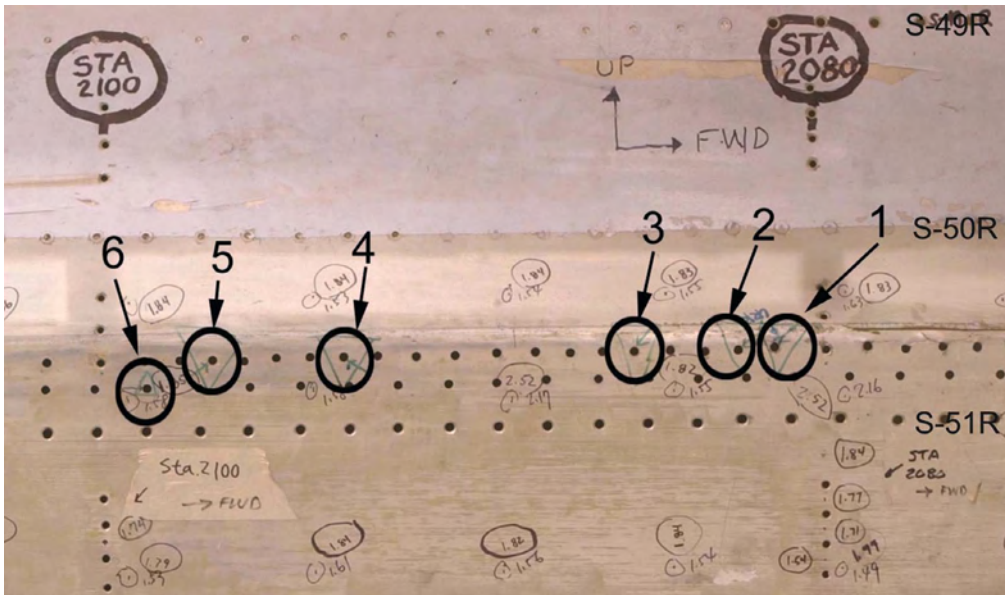

Figure 50. COOKIE CUT LOCATIONS

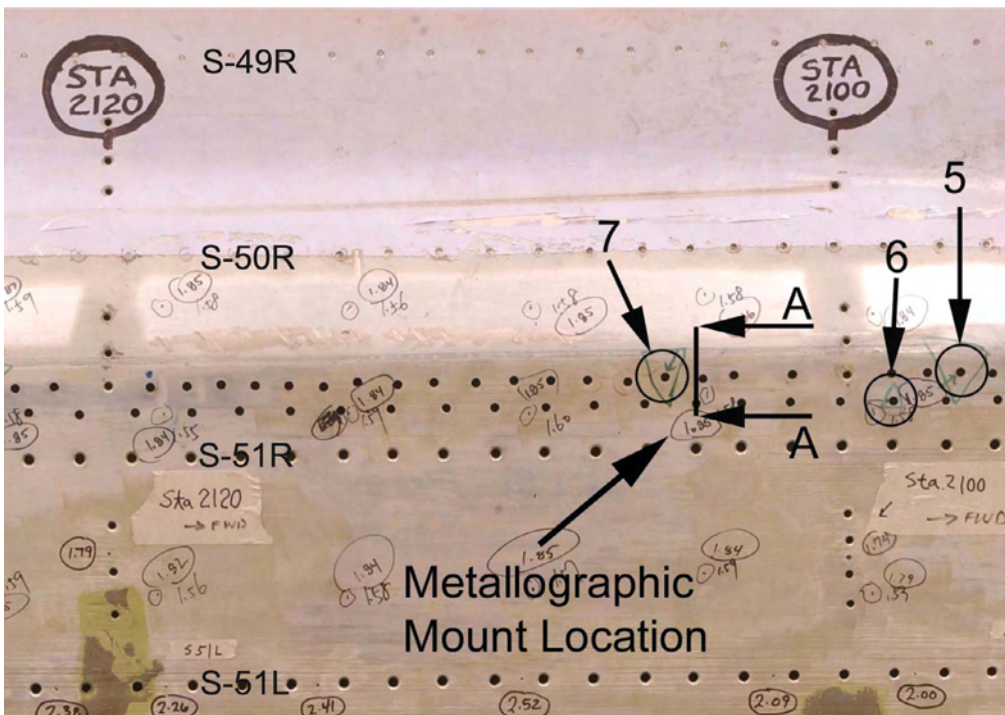

Figure 51. COOKIE CUT LOCATIONS

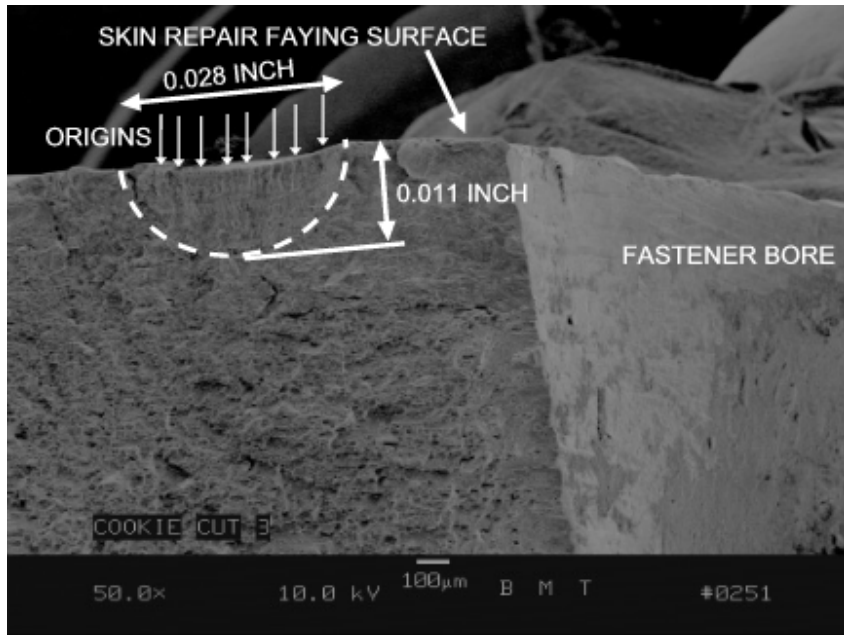

Figure 54. COOKIE CUT # 3 FATIGUE CRACK FEATURES – The extent of fatigue cracking is identified with a dashed line. Multiple fatigue origins are denoted with arrows.

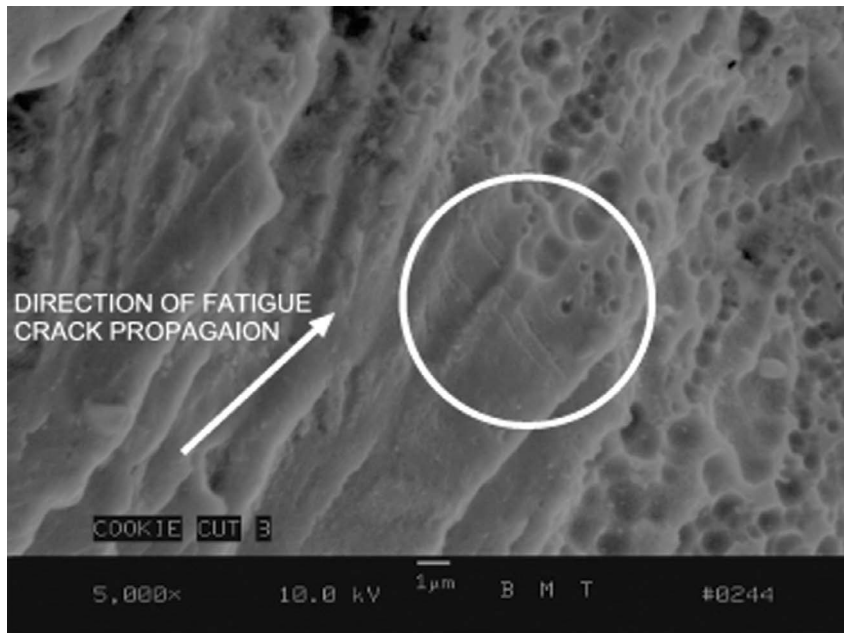

Figure 55. FATIGUE FEATUES FOUND IN CRACK AT COOKIE CUT #3 - Circled area identifies typical fatigue striations characteristic of fuselage pressure cycles observed at the maximum depth of cracking in Cookie Cut #3

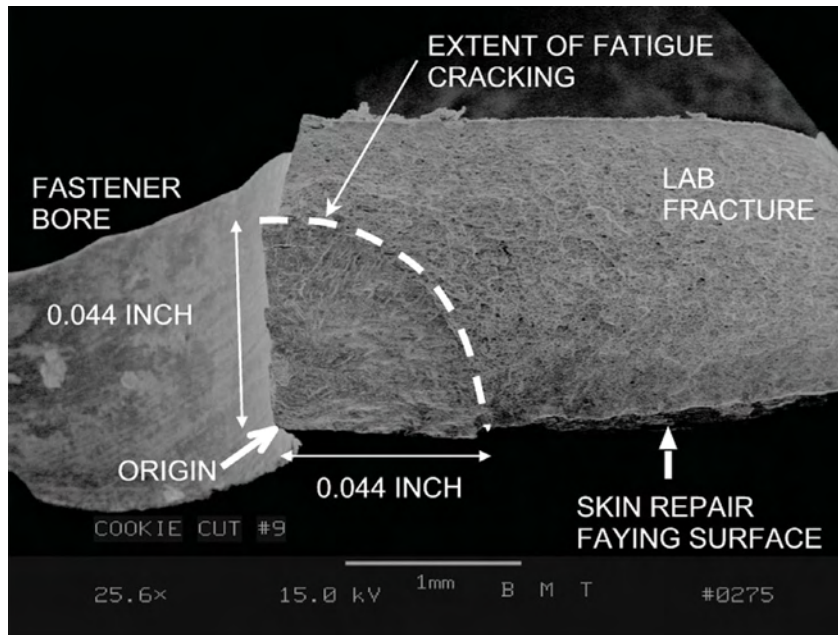

Figure 56. COOKIE CUT #9 FATIGUE CRACK FEATURES - Cracking initiated from the single origin noted above.

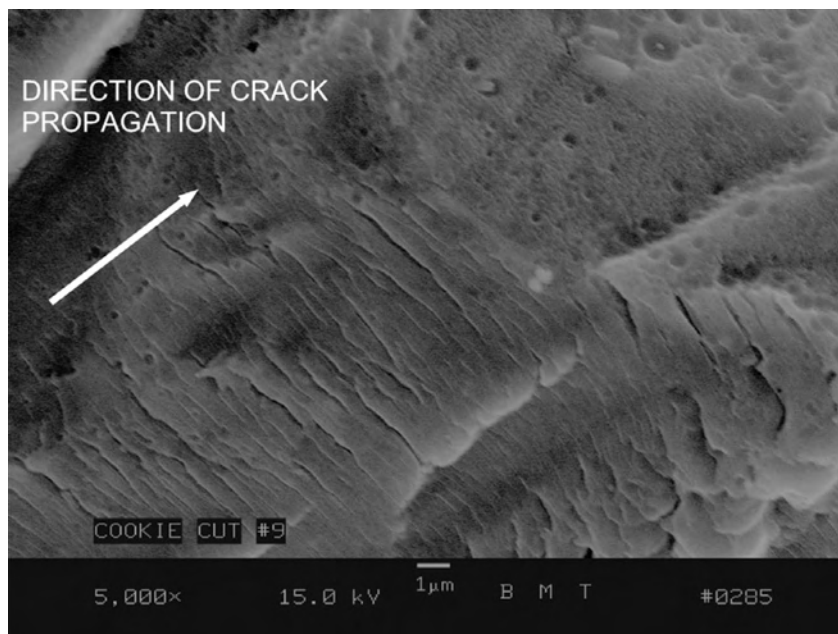

Figure 57. COOKIE CUT #9 FATIGUE STRIATIONS – The above features were located at the maximum extension of the fatigue crack.

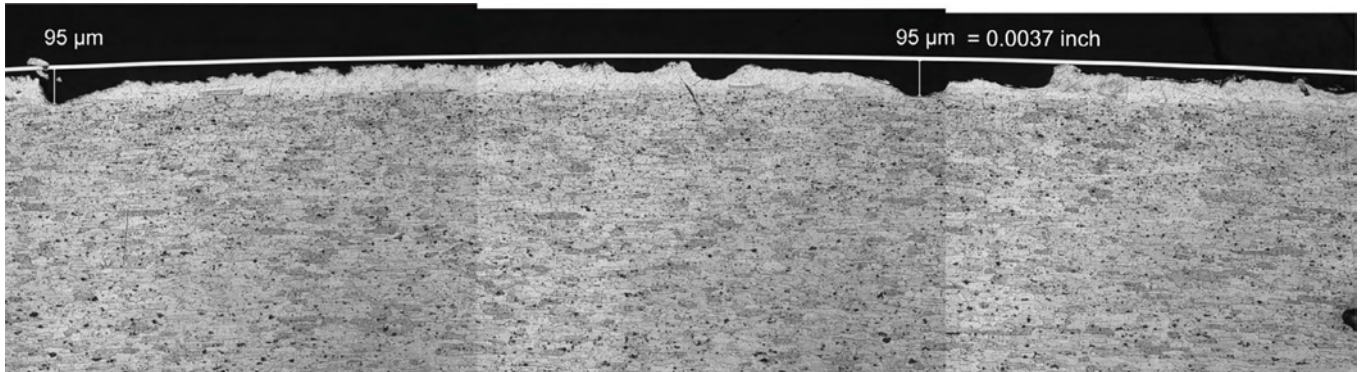

Figure 58. FILLET SEAL SCRATCH FEATURES - These skin surface features were observed at Plane A-A Figure. The clad layer of the skin appears to be penetrated at both measurement locations.



Figure 59. OUTER FASTENER ROW SCRATCH FEATURES AT PLANE A-A – Skin damage at this location was much less severe than on the left hand side of repair doubler. Skin cladding was not compromised by surface damage in this view.

TABLE IX
MECHANICAL PROPETERY TESTS RESULTS FOR THE ITEM 640 C1 SKIN

LONGITUDINAL PROPERTIES

SAMPLE	TENSILE ULTIMATE STRENGTH F_{tu} (KSI)	TENSILE YIELD STRENGTH F_{ty} (KSI)	PERCENT ELONGATION (2.00 INCH GAGE)
L1	68.7	54.0	19.2
L2	68.6	53.0	19.4
L3	69.9	53.6	19.6
REQUIRED ¹	61.0	40.0	15.0

LONG TRANSVERSE PROPERTIES

SAMPLE	TENSILE ULTIMATE STRENGTH F_{tu} (KSI)	TENSILE YIELD STRENGTH F_{ty} (KSI)	PERCENT ELONGATION (2.00 INCH GAGE)
LT1	67.4	46.8	9.9
LT2	67.0	46.4	9.8
LT3	67/4	46.8	10.0
REQUIRED ¹	N/A	N/A	N/A

NOTE 1 – QQ-A-250/5, “Aluminum Alloy Alcad 2024. Plate and Sheet”, for T3 sheet 0.063 to 0.128 inch thick

Figure 60.

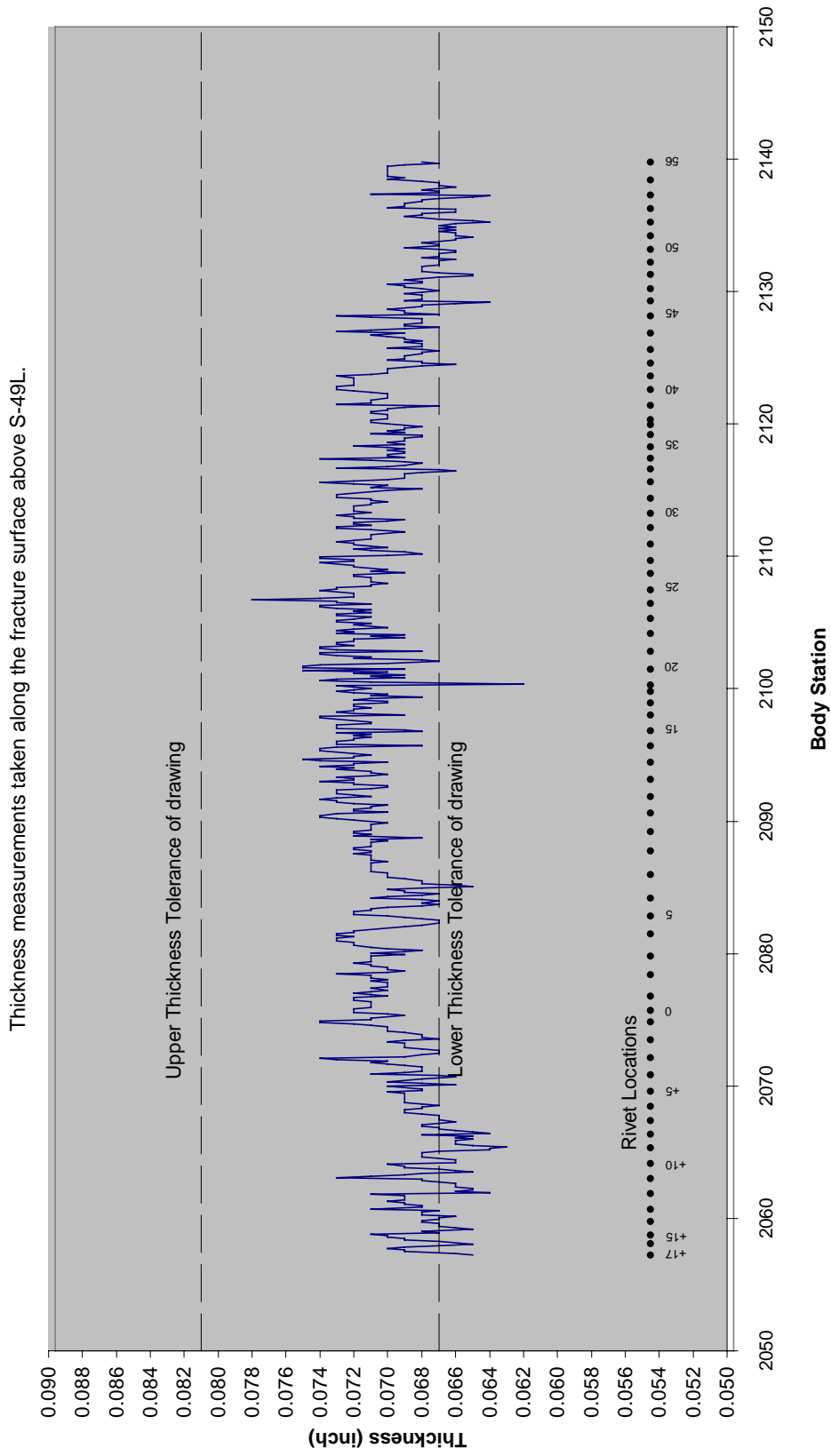

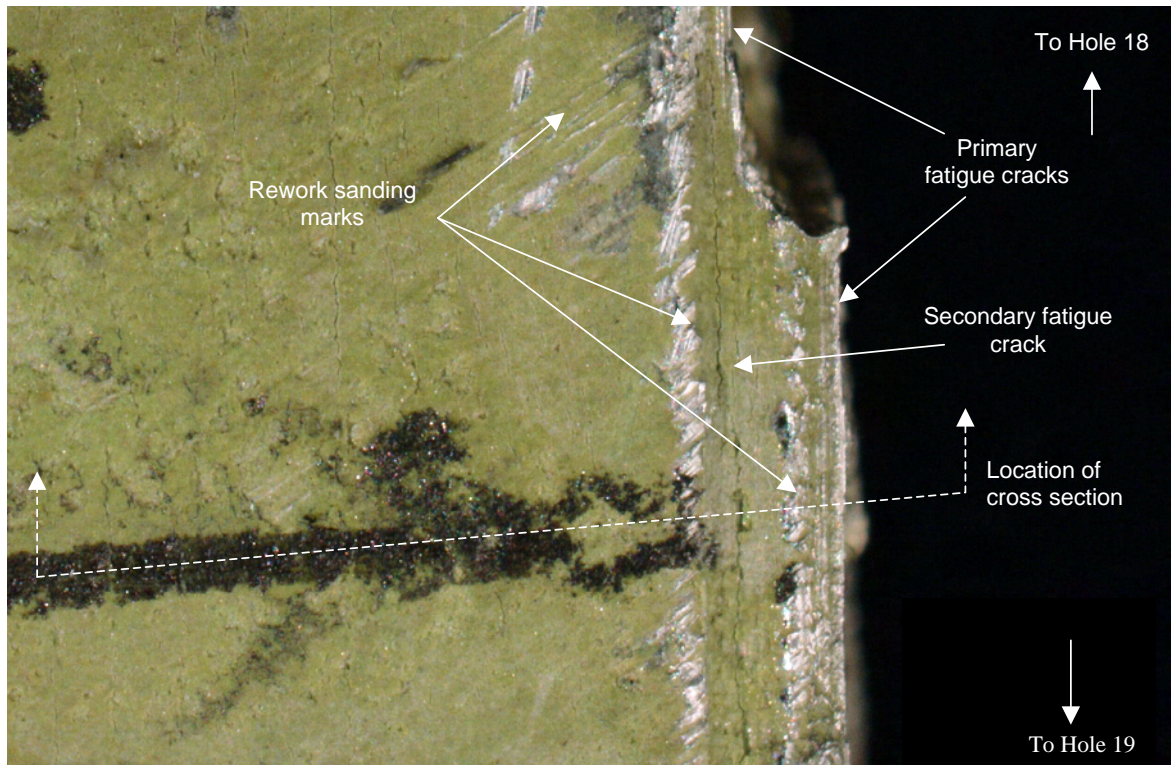

Figure 61. Location of cross section taken to characterize the scratch depth and geometry in the main fatigue region between holes 18 and 19.

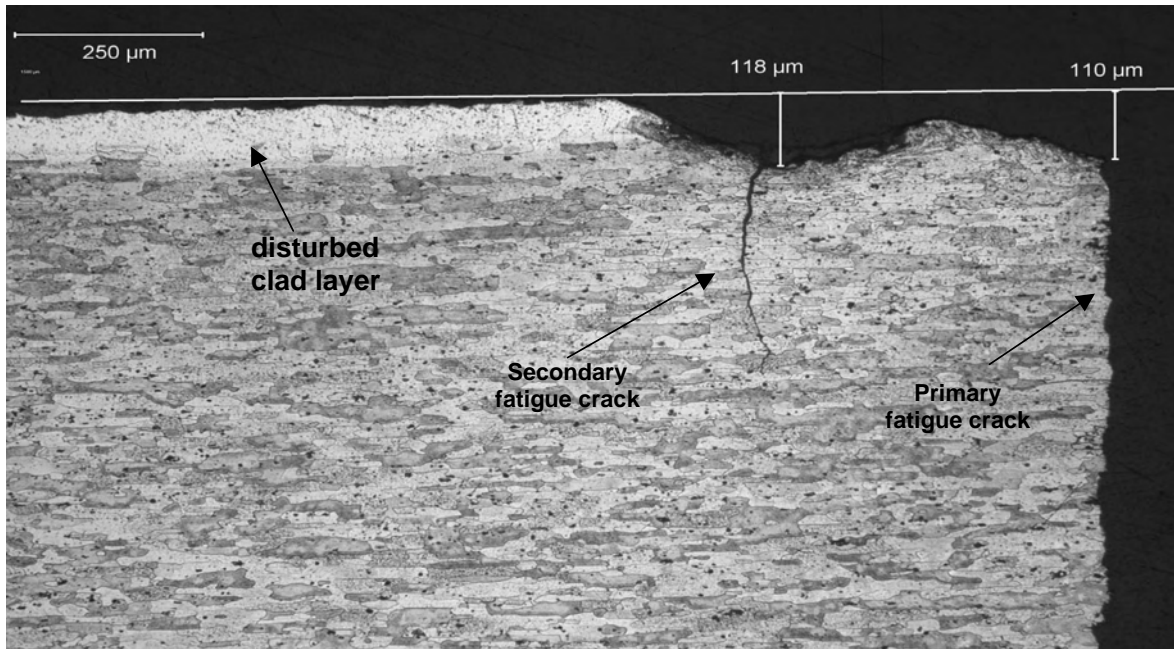

Figure 62. Metallographic specimen through the area indicated in Figure 61 above. The line shown was projected back to an area of undisturbed clad material to determine the depth of the scratches at the primary and secondary fatigue cracks present in this area.

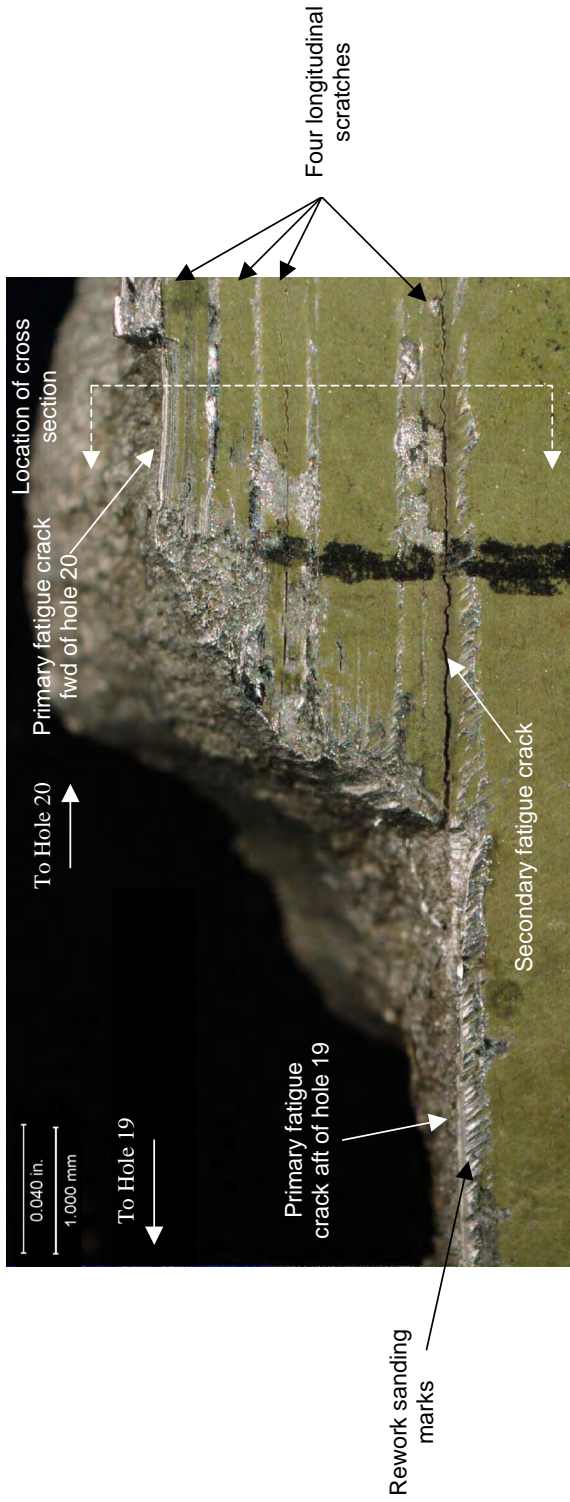

Figure 63. Location of cross section taken to characterize the scratch depth and in the main fatigue region between holes 19 and 20.



Figure 64. Metallographic montage through the area indicated in Figure 63 above. The line shown was projected back to an area of undisturbed clad material to determine the depth of the scratches at the primary and secondary fatigue cracks present in this area.

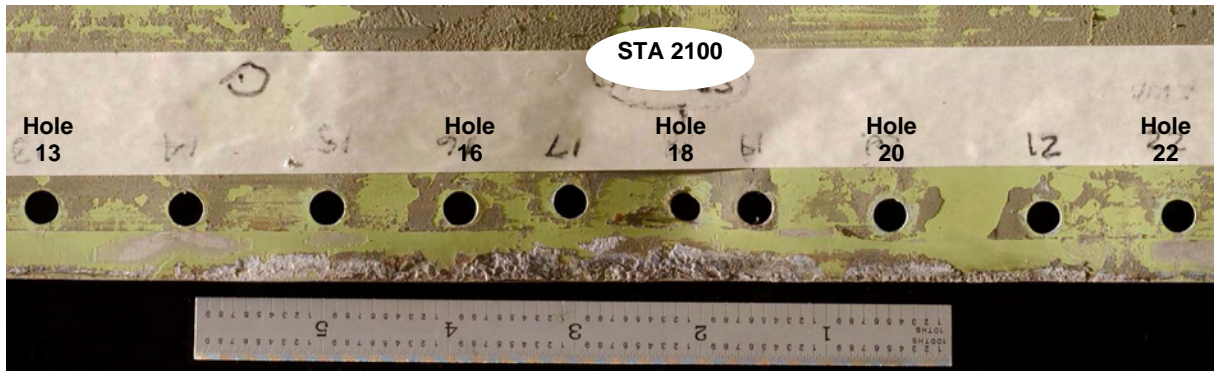

Figure 65.
Faying surface of doubler with skin showing the light colored deposit present from hole 14 to 22.



Figure 66.
Higher magnification image of light colored deposit on faying surface of doubler in the vicinity of hole 15. Note the smooth bubbled appearance of the deposit adjacent to the edge of the doubler indicative of paint flow into the joint.

Figure 67.
 FT-IR analysis spectra of light colored material removed from overhanging portion of doubler faying surface adjacent to hole 18 and spectra from light blue exterior pain on the doubler. These spectra are baseline corrected and scaled to make an easier comparison.

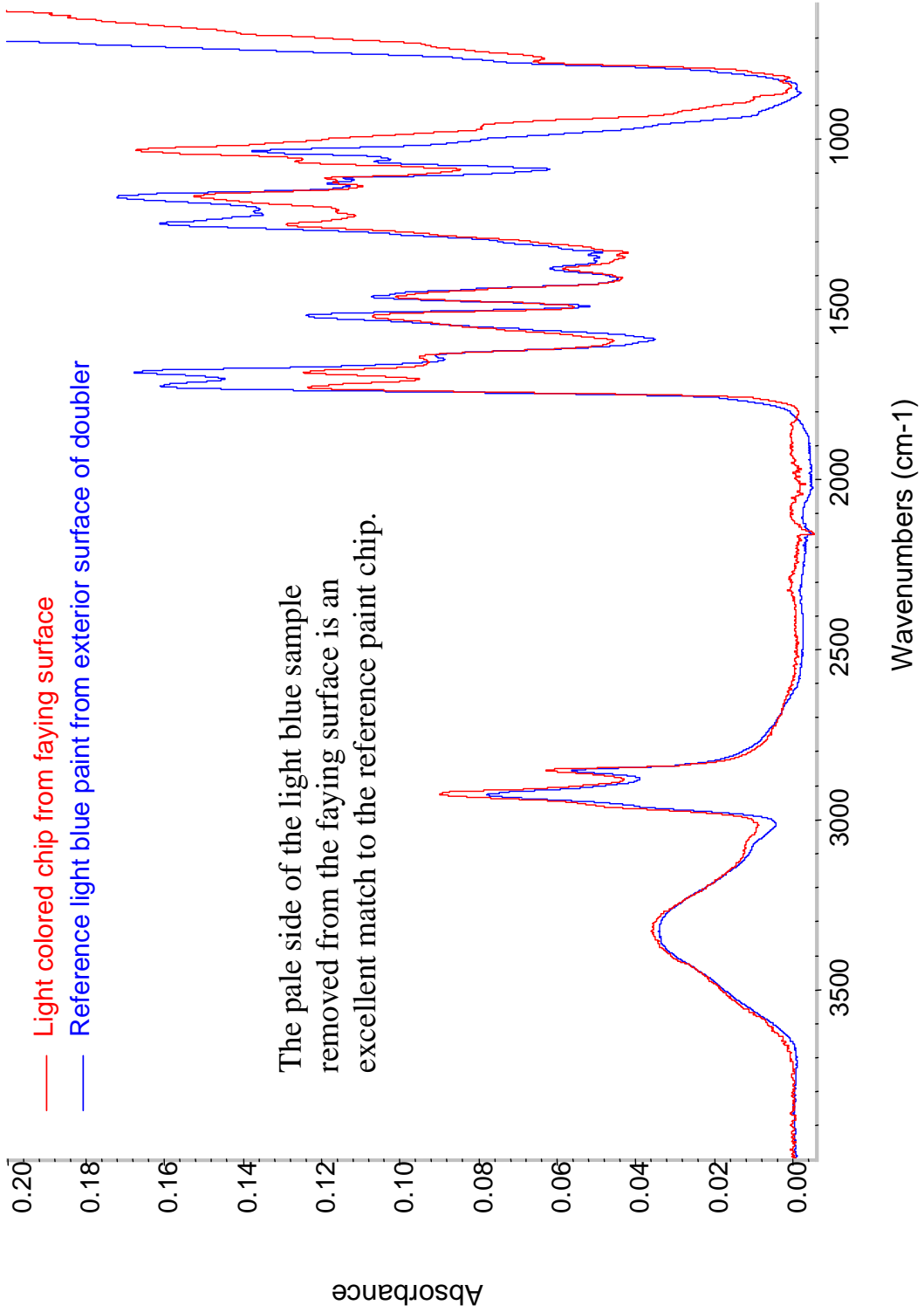
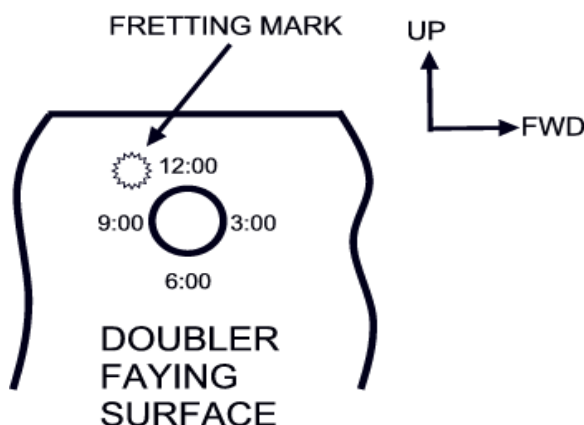

Table X

Degree and position of fretting damage present on overhanging portion of the faying surface of the repair doubler above the S-49L fracture surface.



FASTENER HOLE	DEGREE OF FRETTING	CLOCK POSITION OF FRETTING	FASTENER HOLE	DEGREE OF FRETTING	CLOCK POSITION OF FRETTING
+16	Minor	10:00	18	Minor	10:00 and 2:00
+15	Minor	9:00	19	Significant	10:00
+14	Minor	11:00	20	Minor	11:00
+13	Minor	10:00	22	Significant	10:00 to 2:00
+12	Minor	9:00 to 10:00	23	Minor	12:00
+11	Minor	10:00 and 1:00	25	Significant	10:00 to 2:00
+10	Minor	10:00 and 1:00	26	Significant	11:00 to 1:00
+9	Minor	10:00 and 1:00	27	Minor	12:00
+8	Minor	10:00 and 1:00 to 2:00	28	Significant	12:00 to 2:00
+7	Minor	10:00	29	Significant	12:00
+6	Minor	10:00 and 1:00	30	Significant	10:00 to 2:00
+4	Minor	2:00	32	Significant	10:00 to 2:00
+3	Minor	1:00	34	Significant	10:00 to 2:00
+2	Minor	1:00	35	Minor	2:00
0	Minor	10:00 and 2:00	36	Minor	2:00
1	Minor	12:00	37	Minor	1:00 to 2:00
6	Significant	10:00 to 11:00 and 12:00 to 1:00	38	Significant	10:00 to 2:00
7	Minor	12:00	39	Significant	12:00 to 3:00
8	Significant	10:00 to 1:00	41	Significant	10:00 to 12:00
9	Significant	10:00 to 12:00	42	Significant	10:00 to 2:00
10	Significant	11:00 to 1:00	43	Significant	10:00 and 12:00
11	Minor	12:00	44	Minor	1:00
12	Significant	10:00 to 2:00	46	Minor	2:00
14	Significant	10:00 to 2:00	47	Minor	2:00
15	Significant	10:00 to 2:00	49	Minor	1:00
16	Minor	2:00			



Figure 68.

Faying surface of doubler in the vicinity of hole 6 showing an example of significant fretting damage at the 10:00 to 11:00 and 1:00 to 2:00 clock positions.

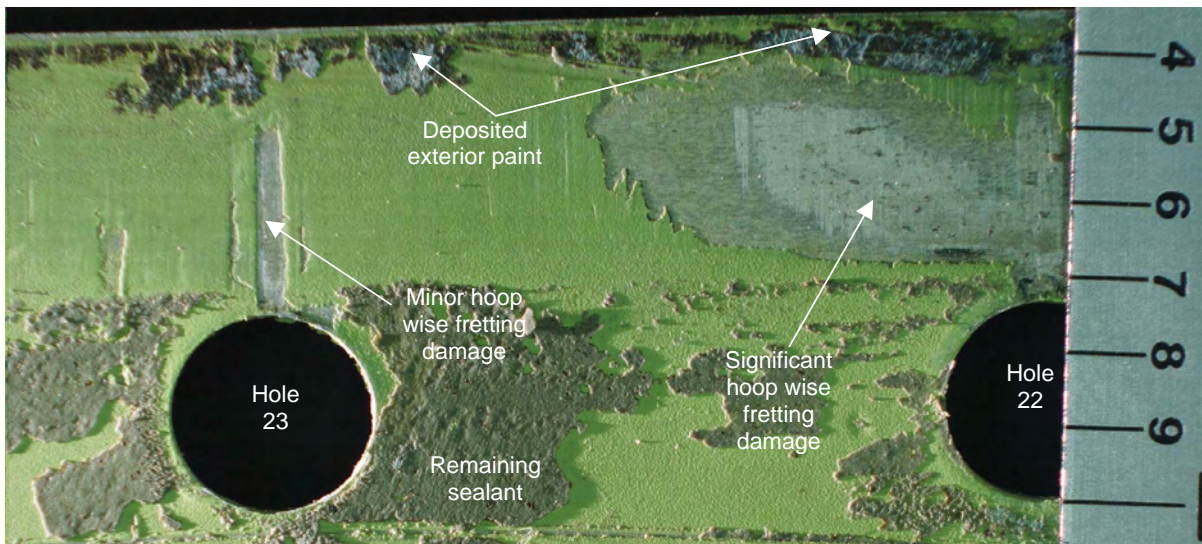

Figure 69.

Faying surface of the doubler showing an example of minor fretting at the 12:00 clock position of hole 23 and significant fretting at the 10:00 to 12:00 clock position of hole 22. Note the presence of deposited paint near the edge of the doubler.

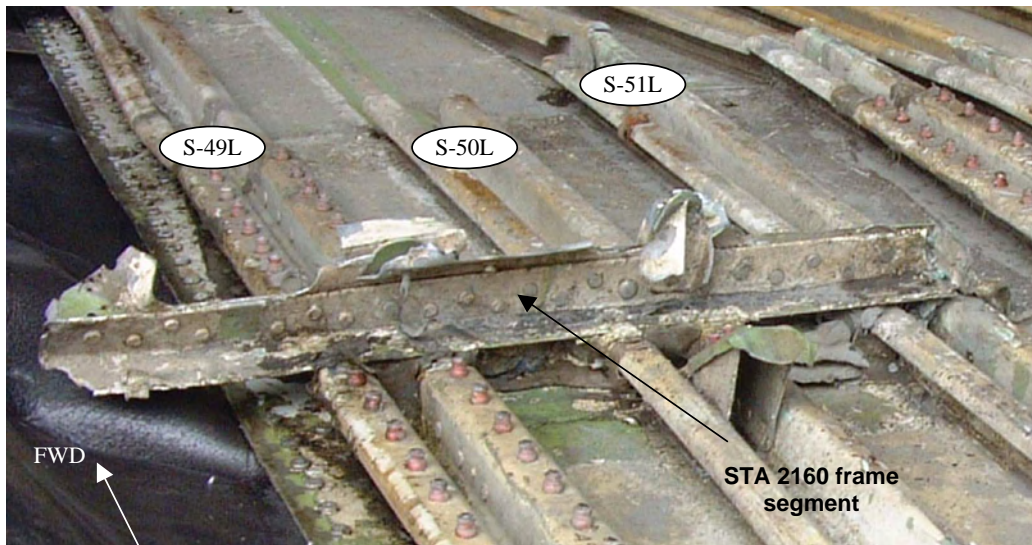

Figure 70.
Condition of the STA 2160 frame segment prior to disassembly from the Item 640C1 skin panel at the CSIST.

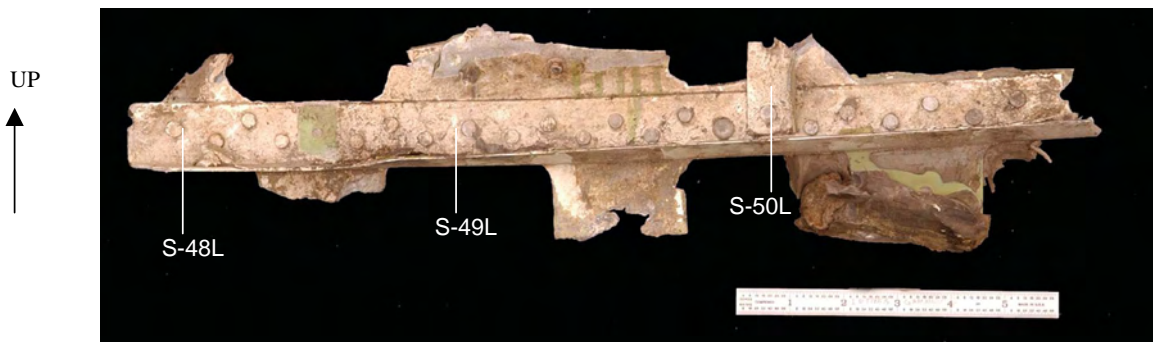

Figure 71.
As received condition of the STA 2160 frame segment submitted for examination. The aft surface is shown in this view.



Figure 72. As received condition of the STA 2160 frame segment submitted for examination. The forward surface is shown in this view.

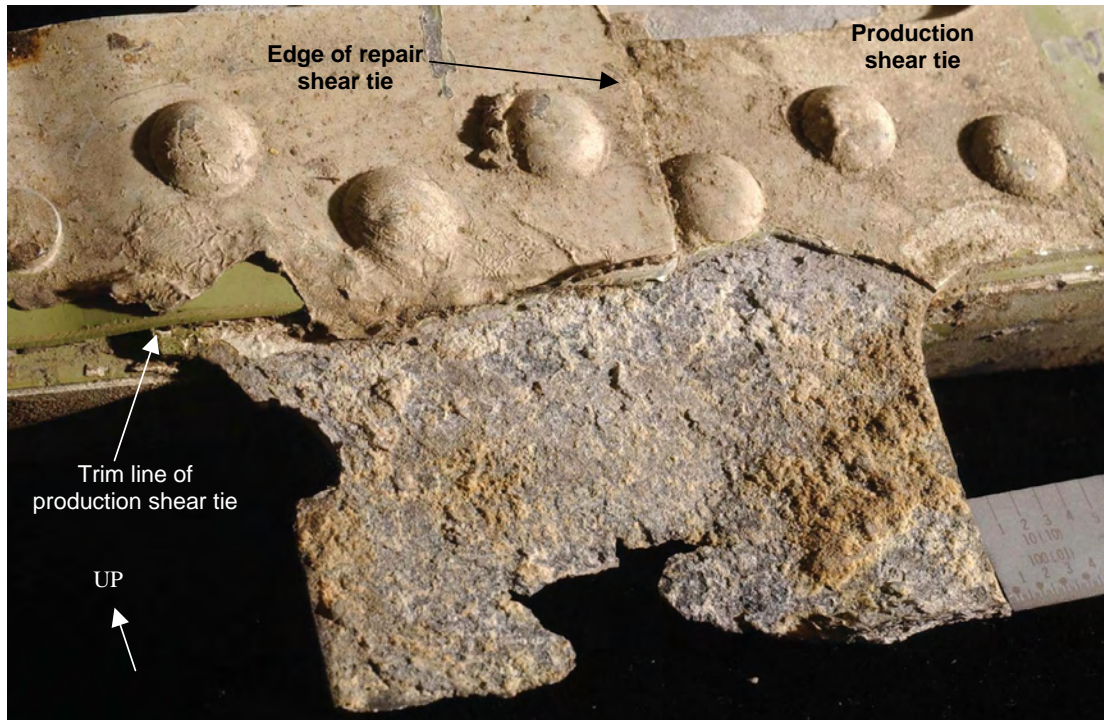

Figure 73.
Exfoliation corrosion present at shear tie between S-50L and S-49L of STA 2160 frame segment.

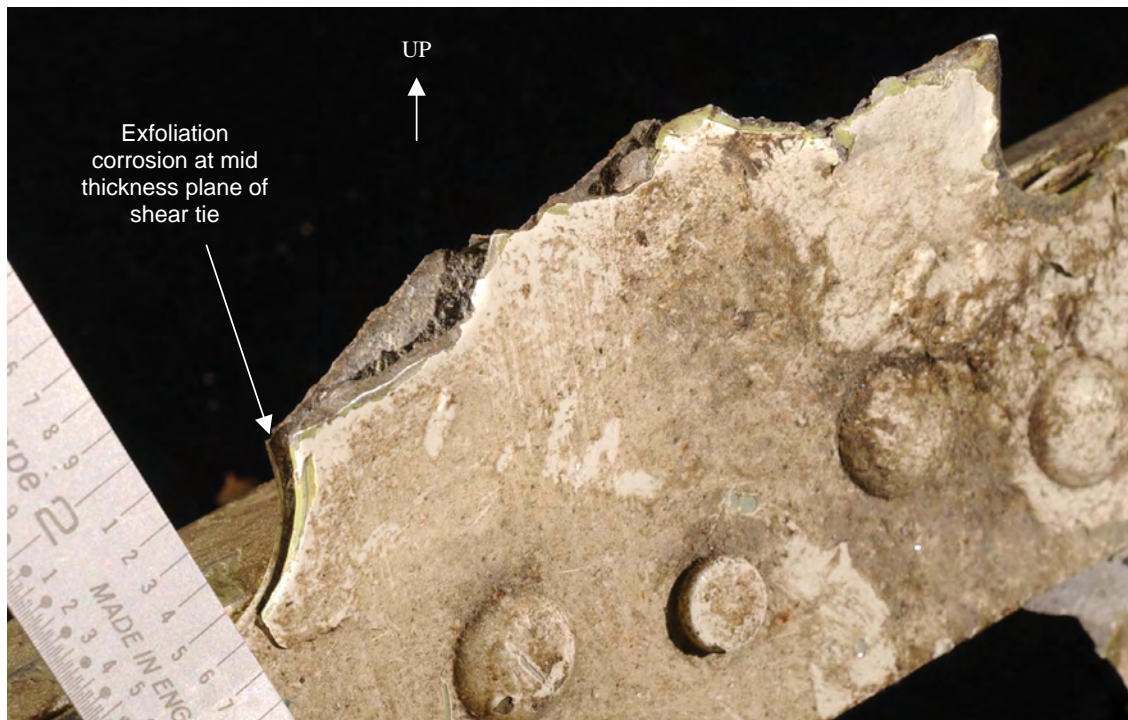

Figure 74.
Exfoliation corrosion present at shear tie between S-49L and S-48L of STA 2160 frame segment.

Table XI

Spectrochemical analysis results.

Frame	Member	Chemical Composition (Percent)										Confirmed Alloy
		Zn	Mg	Cu	Cr	Fe	Si	Mn	Ti	Al		
STA 2160	Shear Tie (repair)	0.14	1.49	4.46	0.02	0.22	0.09	0.62	0.01	remainder	2024	
	Failsafte Chord	5.29	2.43	1.34	0.23	0.27	0.12	0.00	0.02	remainder	7075	
STA 2100	Shear Tie	0.11	1.42	4.28	0.03	0.34	0.11	0.58	0.01	remainder	2024	
	Inner Chord	5.60	2.31	1.34	0.22	0.26	0.18	0.03	0.04	remainder	7075	
STA 2060	Failsafe Chord	5.15	2.59	1.36	0.24	0.31	0.10	0.00	0.03	remainder	7075	
	Shear Tie	0.08	1.55	4.11	0.03	0.33	0.11	0.58	0.01	remainder	2024	
STA 2040	Failsafe Chord	5.55	2.56	1.43	0.23	0.24	0.12	0.00	0.01	remainder	7075	
	Shear Tie	0.22	1.36	3.87	0.02	0.29	0.10	0.56	0.02	remainder	2024	
STA 1940	Inner Chord	5.71	2.44	1.37	0.23	0.27	0.19	0.04	0.03	remainder	7075	
	Failsafe Chord	5.29	2.50	1.35	0.22	0.25	0.11	0.00	0.01	remainder	7075	
Countersunk Rivets for Repair Doubler	Shear Tie	0.07	1.68	4.10	0.03	0.34	0.11	0.63	0.01	remainder	2024	
	Inner Chord	5.51	2.58	1.50	0.24	0.28	0.09	0.00	0.03	remainder	7075	
Countersunk Rivets for Repair Doubler	Failsafe Chord	5.44	2.62	1.50	0.25	0.31	0.15	0.06	0.02	remainder	7075	
	Inner Chord	0.06	0.50	4.40	0.03	0.53	0.35	0.50	0.02	remainder	2017	
Countersunk Rivets for Repair Doubler	Shear Tie	0.05	0.71	3.72	0.02	0.52	0.48	0.61	0.03	remainder	2017	

Material Specification Requirements	Chemical Composition (Percent)									
	Zn	Mg	Cu	Cr	Fe	Si	Mn	Ti	Al	
2024 Alloy per QQ-A-250/4	0.25 max	1.2 - 1.8	3.8 - 4.9	0.10 max	0.50 max	0.50 max	0.30- 0.09	0.15 max	remainder	
7075 Alloy per QQ-A-200/11	5.1 to 6.1	2.1 - 2.9	1.2 - 2.0	0.18- 0.28	0.50 max	0.40 max	0.30 max	0.20 max	remainder	
2017 Alloy per QQ-A-430	.25 max	0.40- 0.80	3.5 - 4.5	0.10 max	0.70 max	0.20 -0.80	0.40 - 0.80	0.15 max	remainder	

Table XII

Temper inspection results for frame segments.

Frame	Member	Average Hardness (Rockwell B)	Average Conductivity (%IACS)	Confirmed Alloy* & Temper
STA 2160	Shear Tie (repair)	74.0	30.3	2024-T4X
	Failsafe Chord	90.9	32.3	7075-T6XXX
STA 2100	Shear Tie	68.8	30.5	2024-T4X
	Inner Chord	90.1	32.1	7075-T6XXX
	Failsafe Chord	90.7	31.9	7075-T6XXX
STA 2060	Shear Tie	71.6	29.3	2024-T4X
	Failsafe Chord	92.0	31.8	7075-T6XXX
STA 2040	Shear Tie	71.0	30.1	2024-T4X
	Inner Chord	92.3	32.6	7075-T6XXX
	Failsafe Chord	90.8	32.6	7075-T6XXX
STA 1940	Shear Tie	69.0	30.8	2024-T4X
	Inner Chord	92.1	32.5	7075-T6XXX
	Failsafe Chord	90.8	31.0	7075-T6XXX

COUNTERSUNK REPAIR RIVETS

Rivet Number	Average Hardness (Rockwell B)	Average Conductivity (%IACS)	Confirmed Alloy* & Temper
E64	79.2	35.0	2117-T4XXX
D51	72.7	34.5	2117-T4XXX

BAC 5946 "Temper Inspection of Aluminum Alloys" Requirements	Hardness (Rockwell B)	Conductivity (%IACS)
2017-T4XXX	68 - 80	31.5 - 35.0
2024-T4X	63 - 83.5	28.5 - 32.0
7075-T6XXX	83.5 - 94	30.0 - 35.0

* See previous table for spectrochemical analysis results



Figure 75. As received condition of the STA 2100 frame segment submitted for examination. The aft surface is shown in this view.



Figure 76. As received condition of the STA 2100 frame segment submitted for examination. The forward surface is shown in this view.

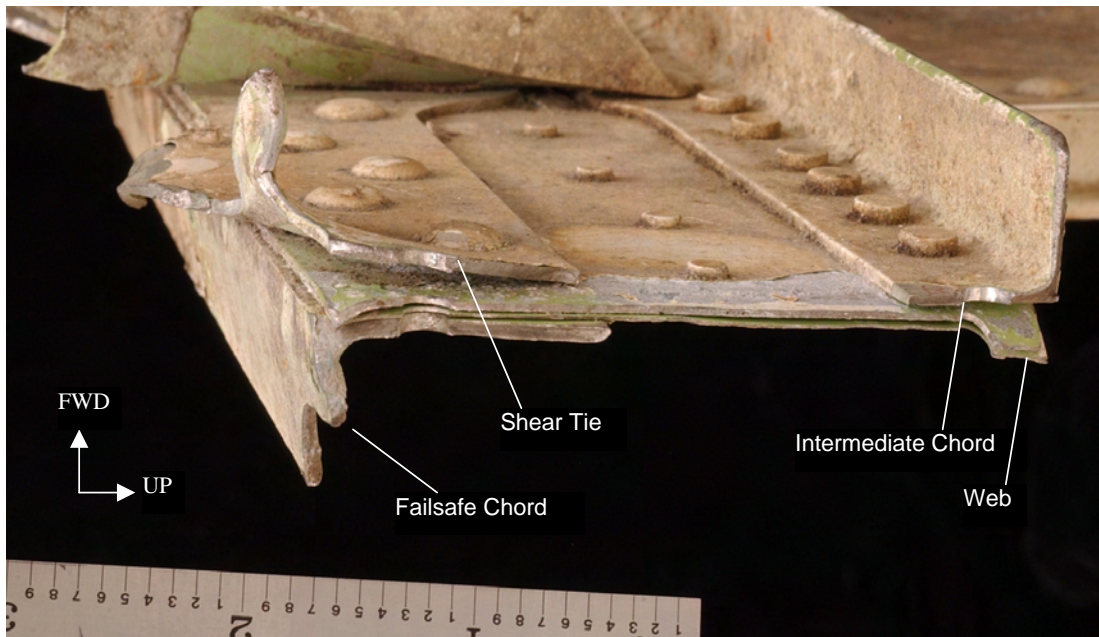

Figure 77.
Fracture at S-49L of the STA 2100 frame segment showing deformation in shear tie and web.



Figure 78.
Shear tie between S-51R and S-50R of the STA 2100 frame segment showing downward deformation in skin flange and pull through of the fastener hole at the inboard most fastener hole.

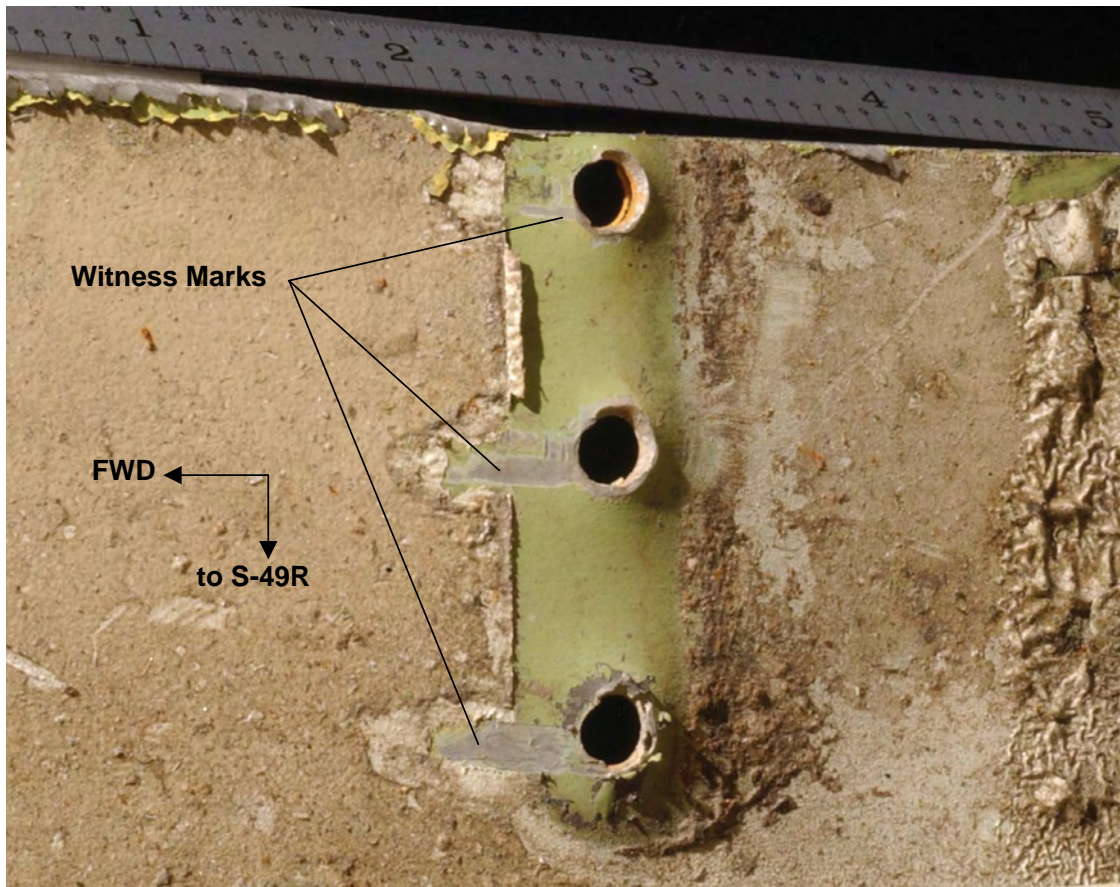

Figure 79.
Witness marks and deformation in skin at shear tie fastener holes common to S-49R /S-48R at STA 2100.

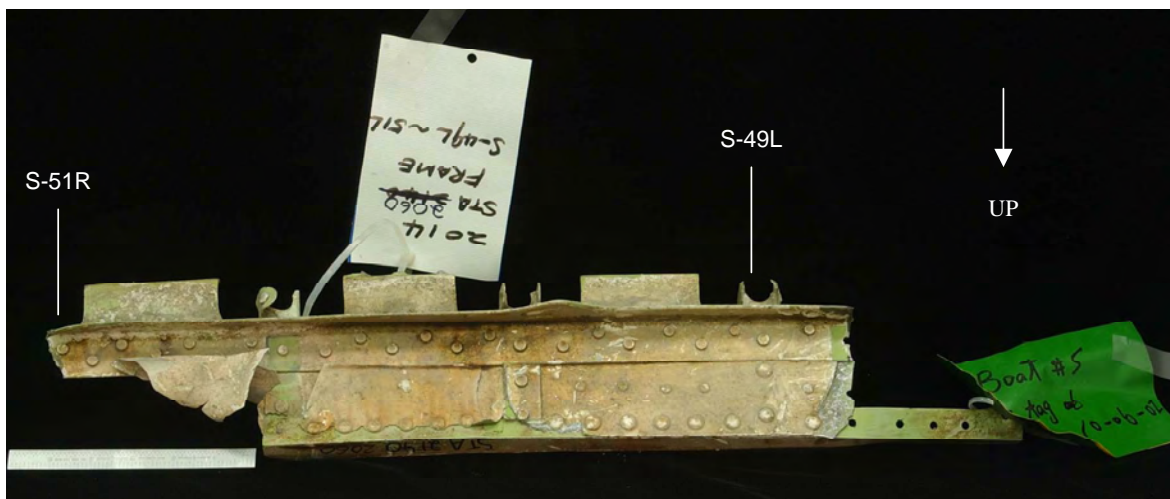

Figure 80. As received condition of the STA 2060 frame segment. The aft surface is shown in this view.



Figure 81.
As received condition of the STA 2060 frame segment. The forward surface is shown in this view.

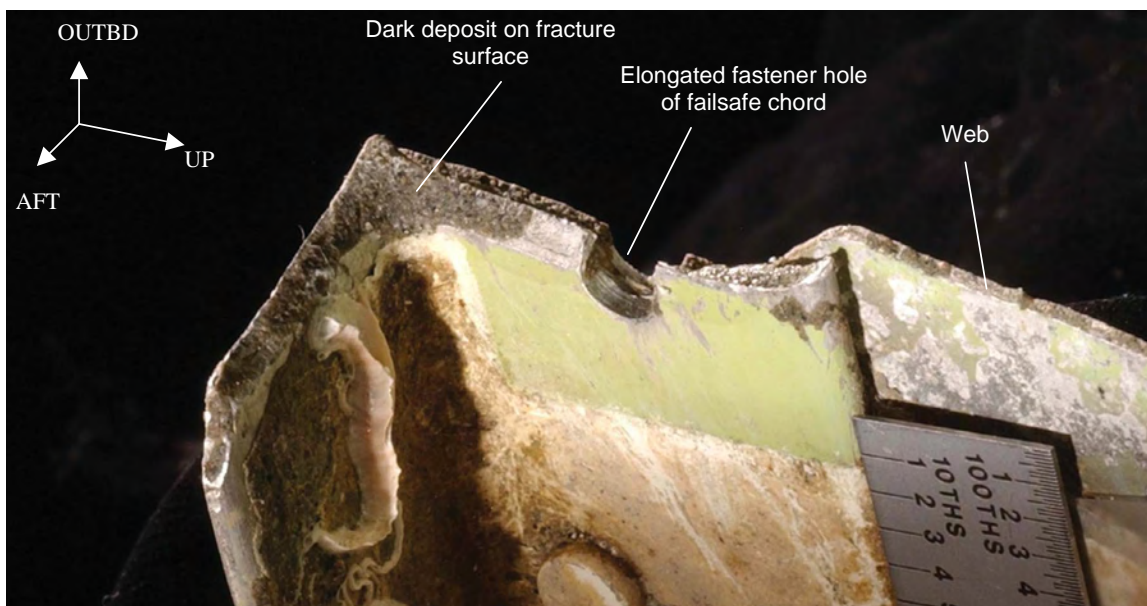

Figure 82.
Fracture surface of failsafe chord and web common to S-49L of the STA 2060 frame segment.

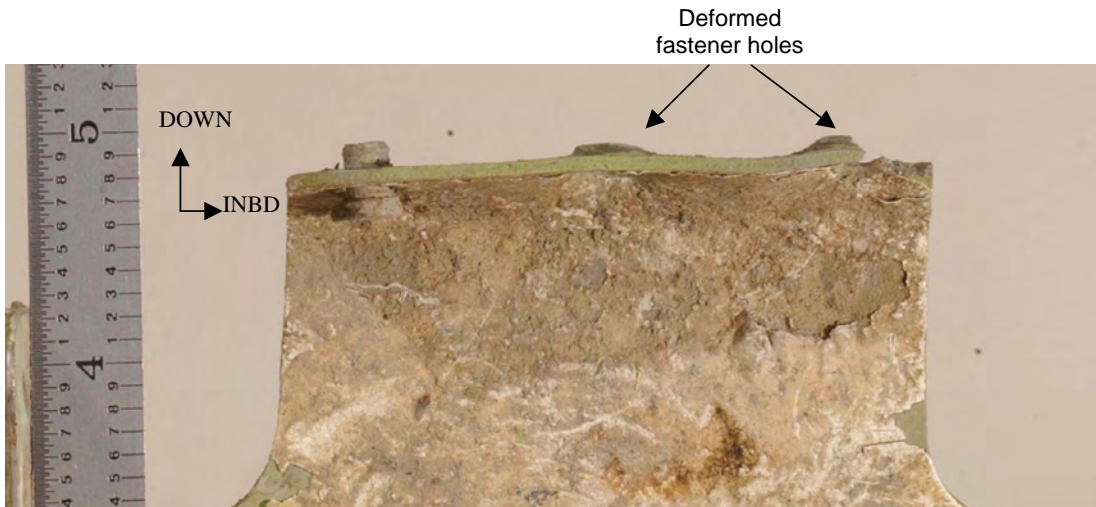

Figure 83.
Shear tie between S-51L and S-50L of the STA 2060 frame segment showing deformation of skin flange fastener holes in the downward direction.

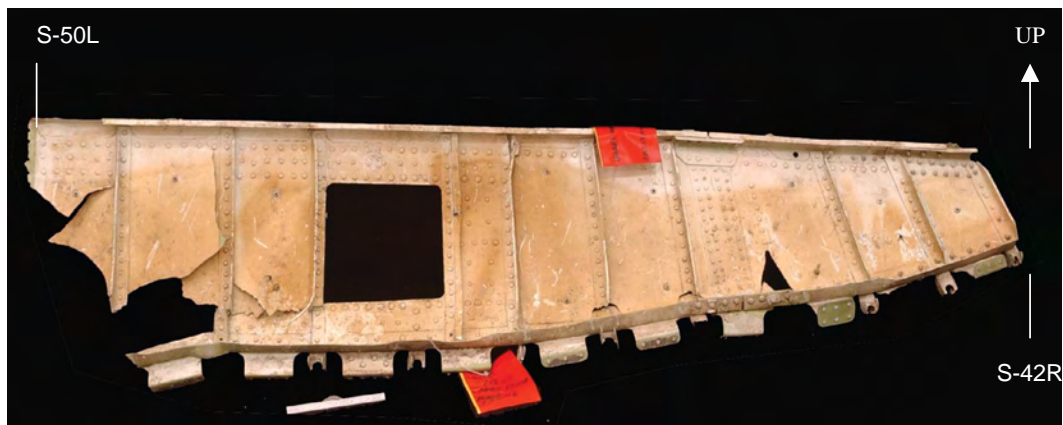

Figure 84. As received condition of the STA 2040 frame segment submitted for examination. The aft surface is shown.



Figure 85. As received condition of the STA 2040 frame segment submitted for examination. The forward surface is shown in this view.

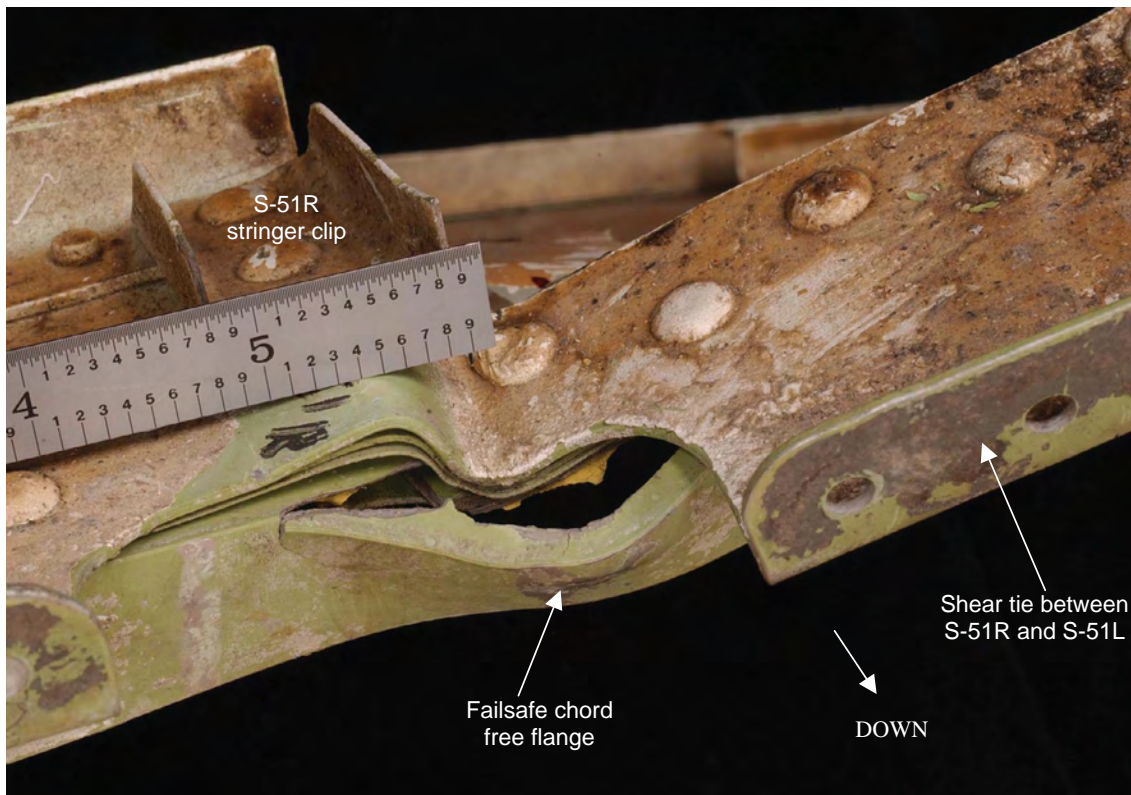

Figure 86. Fracture in failsafe chord free flange radius at S-51R of the STA 2040 frame segment.

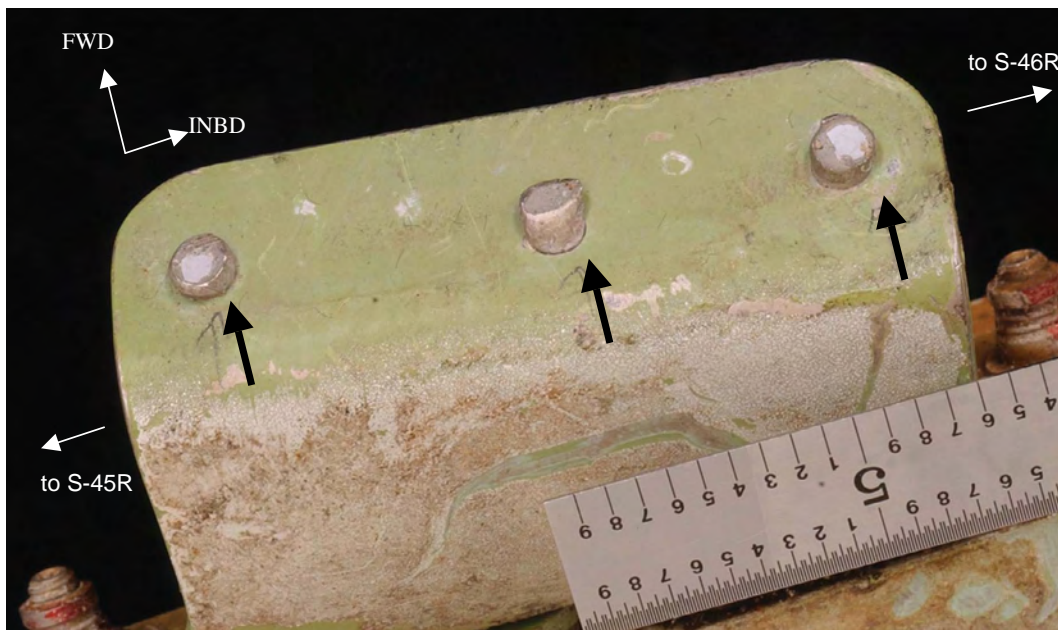

Figure 87. Skin flange rivet fractures at shear tie between S-45R and S-46R of the STA 2040 frame. Black arrows indicate the direction of loading.



Figure 88. Skin flange rivet fractures at shear tie between S-49R and S-50R of the STA 2040 frame segment. Black arrows indicate the direction of loading.



Figure 89. As received condition of the STA 1940 frame segment submitted for examination. The aft surface is shown in this view.



Figure 90.
As received condition of STA 1940 frame segment submitted for examination.
The forward surface is shown in this view.

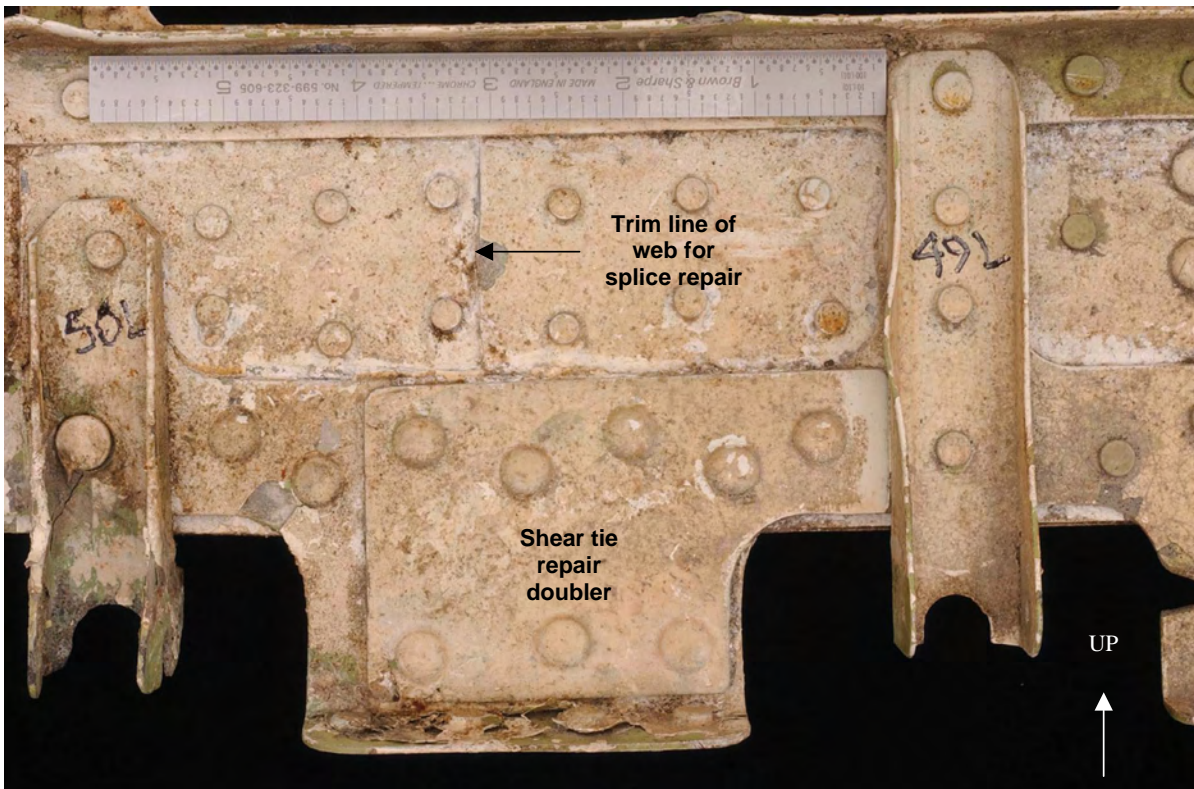

Figure 91.
STA 1940 frame segment showing the shear tie repair doubler and web splice repair
at the location between S-50L and S-49L.

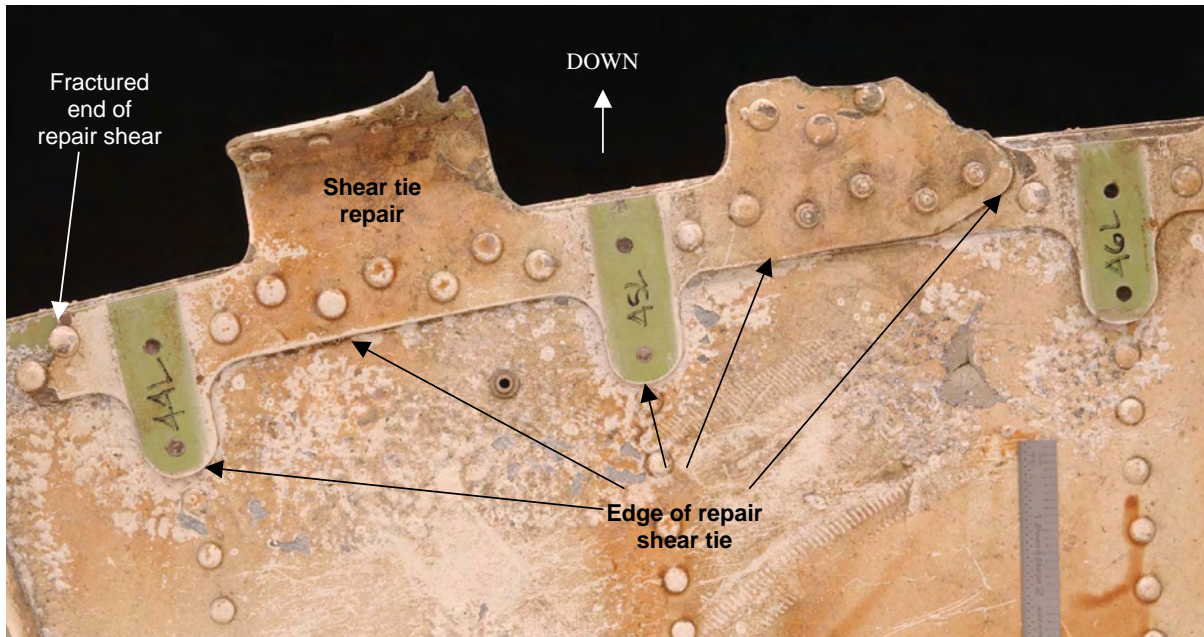

Figure 92.
STA 1940 frame segment showing the shear tie repair between S-46L and S-44L.

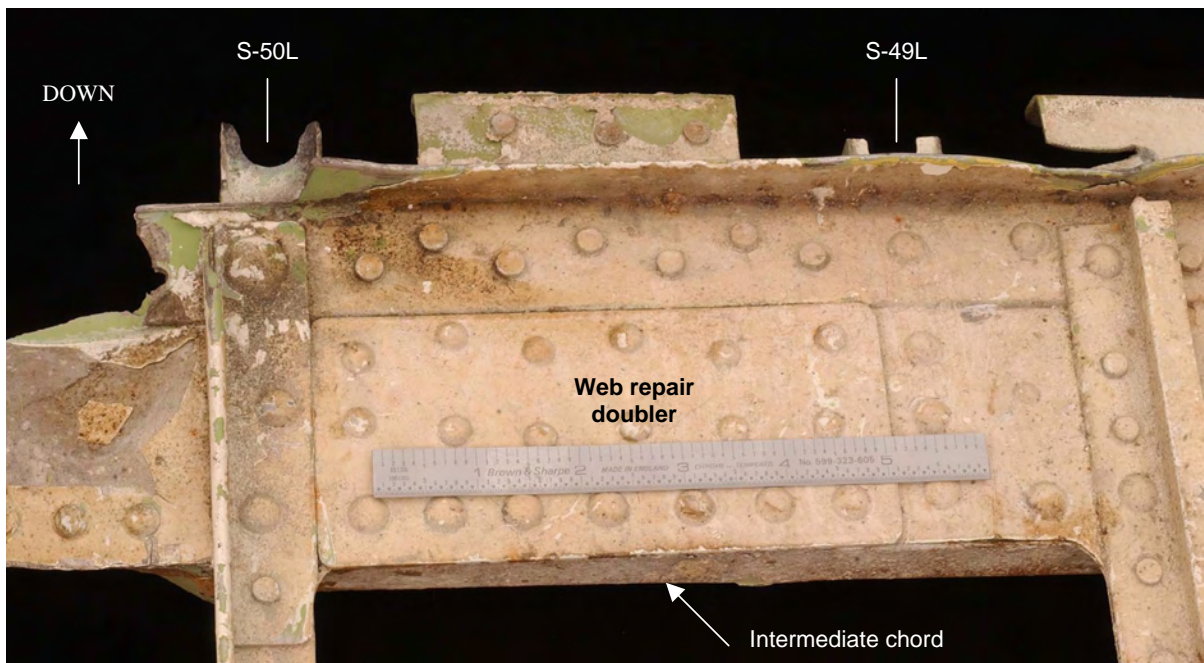

Figure 93.
STA 1940 frame segment showing the web repair doubler on the aft side between S-50L and S-49L.

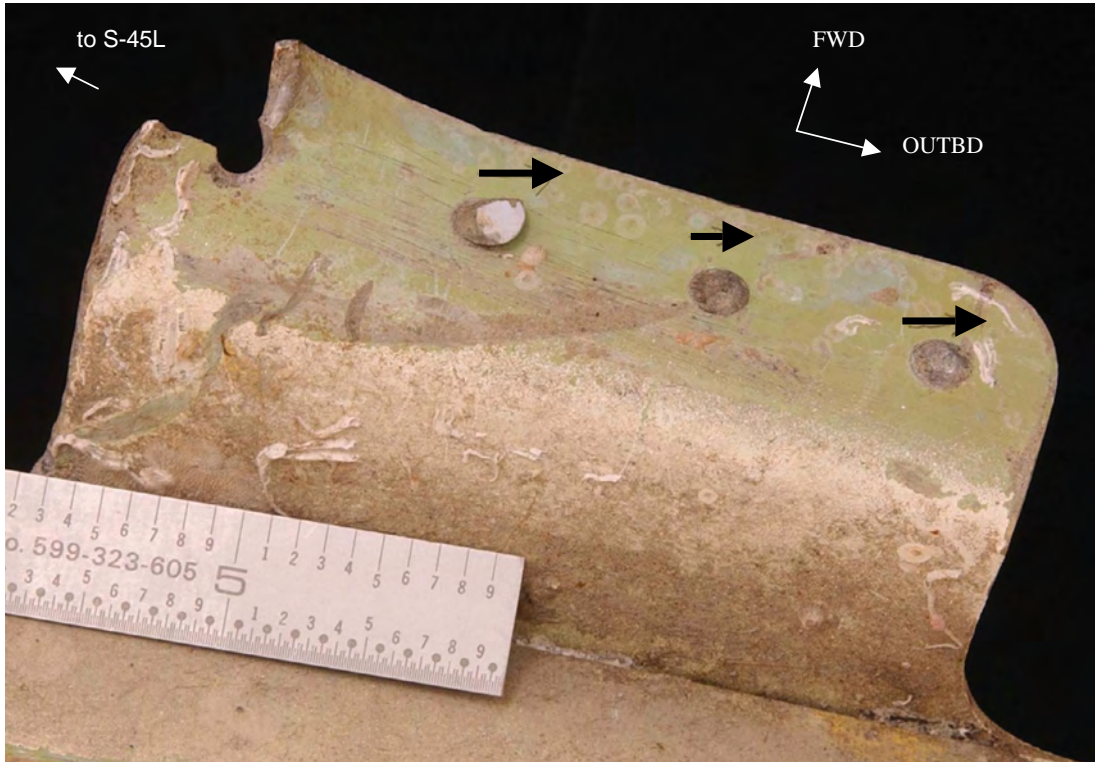

Figure 94. Shear tie between S-45L and S-44L of STA 1940 frame segment.
Black arrows indicate the direction of loading.

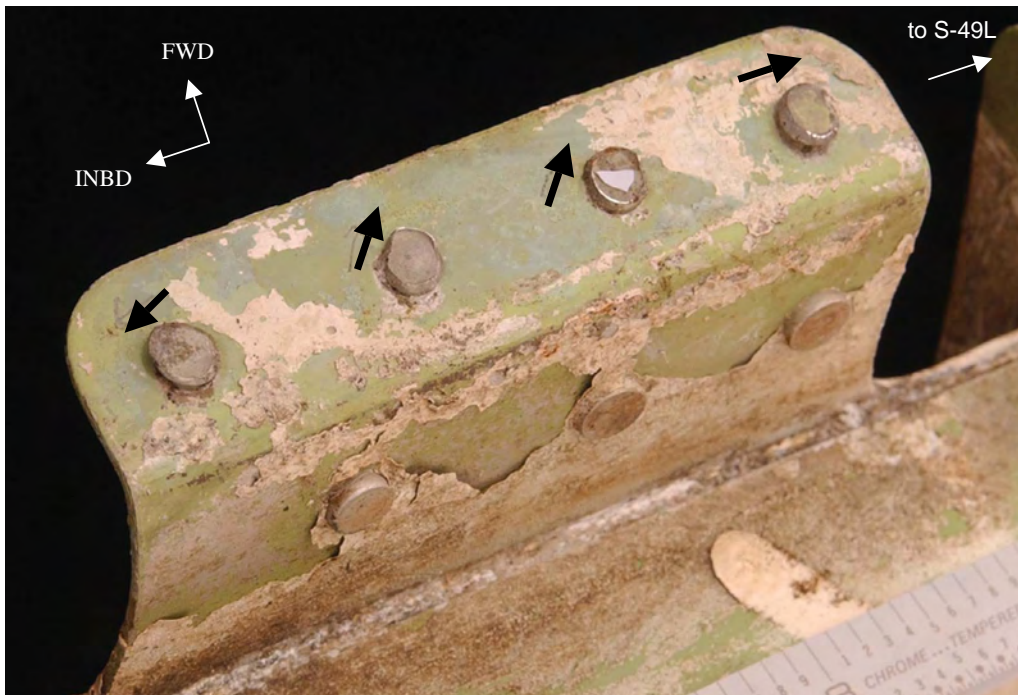

Figure 95. Shear tie between S-50L and S-49L of STA 1940 frame segment.
Black arrows indicate the direction of loading.

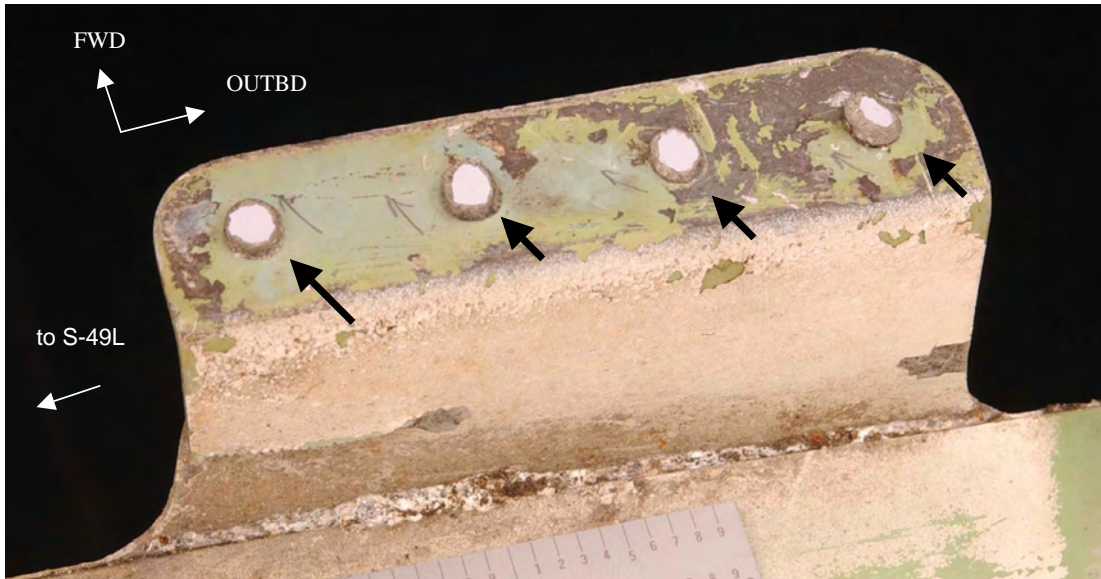

Figure 96.
Shear tie between S-49L and S-48L of STA 1940 frame segment.
Black arrows indicate the direction of loading.

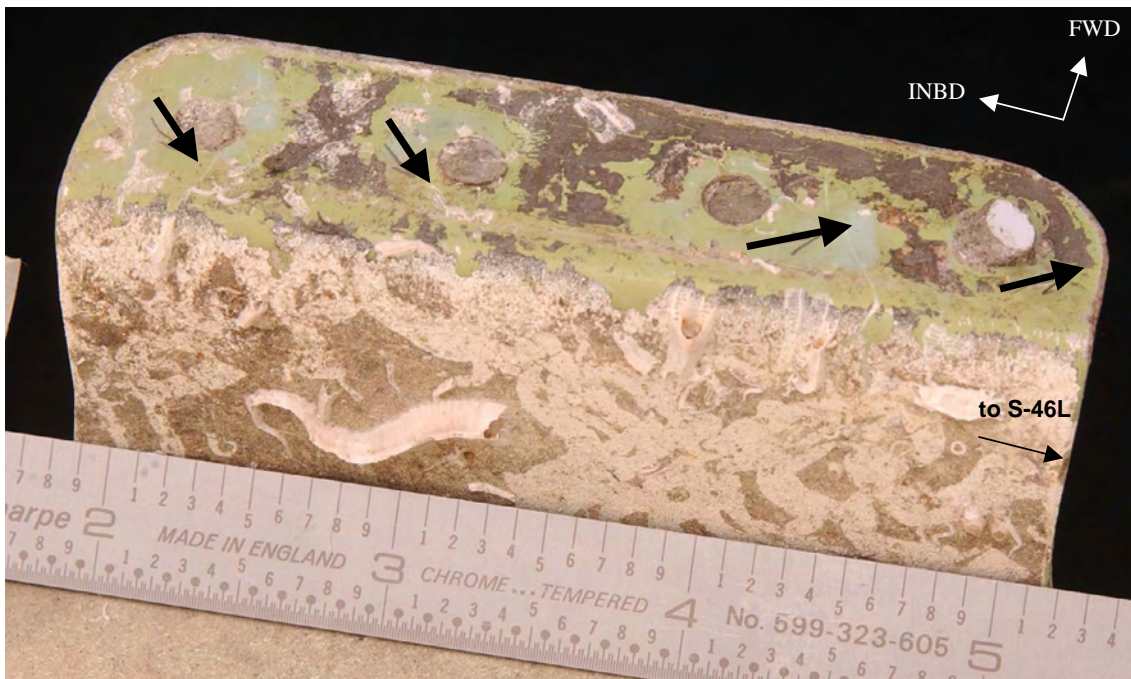

Figure 97.
Shear tie between S-47L and S-46L of STA 1940 frame segment.
Black arrows indicate the direction of loading.

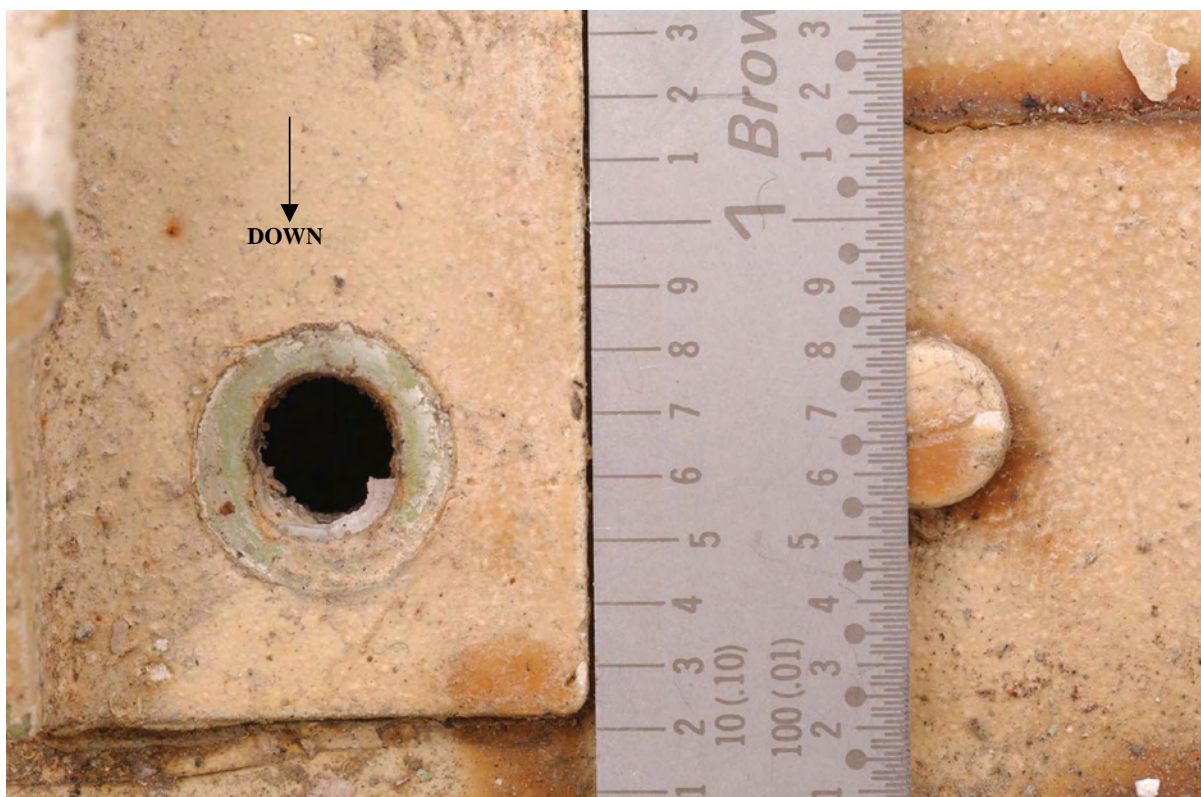

Figure 98.
FWD view of STA 1940 frame segment showing downward deformation of the lower attachment hole of shear tie at S-47L clip.

BMT
BOEING MATERIALS TECHNOLOGY
MS 22570

APPENDIX I

MS 22570 Appendix I

Hole # +3

Cycles	Crack Length (mm)	da/dN (micron/cycle)	Photo #209	x0=27.100	y0=11.848	slope	theta (absolute)	deviation angle
	1.410175876		EOC *	26.84	13.234	-5.3308	1.3853613	
	0.218141585	0.07692	210	26.999	12.051	-2.0099	1.1091211	0.2762402
217	0.237307988	0.10000	211	26.991	12.069	-2.0275	1.1125933	0.2727679
703	0.304387564	0.09091	212	26.995	12.138	-2.7619	1.2234104	0.1619509
116	0.315506745	0.10000	213	26.988	12.148	-2.6786	1.2134876	0.1718736
207	0.333257722	0.07143	214	27.009	12.17	-3.5385	1.2953702	0.089991
1594	0.45660262	0.08333	215	27.049	12.303	-8.9216	1.4591743	0.0738131
2746	0.669085336	0.07143	216	27.168	12.516	9.82353	1.4693494	0.0839881
997	0.754529998	0.10000	217	27.141	12.608	18.5366	1.5169012	0.1315399
222	0.776705955	0.10000	218	27.144	12.63	17.7727	1.5145896	0.1292284
543	0.821917337	0.06667	219	27.144	12.676	18.8182	1.5177062	0.1323449
614	0.8862313	0.14286	220	27.125	12.745	35.88	1.5429329	0.1575716
34	0.908282451	1.14286	221	27.106	12.771	153.833	1.5642959	0.1789346
26	0.944648127	1.66667	224	27.106	12.808	160	1.5645464	0.1791852
47	1.043245758	2.50000	225	27.161	12.898	17.2131	1.5127663	0.1274051
25	1.111370594	2.85710	226	27.168	12.966	16.4412	1.5100483	0.124687
Total between 8091 1st and Last			x0, y0	27.1	11.848			

105 Last Point to EOC
 2836 Initiation to First Point
11031 Total (including extrapolation)

* EOC(not completely through thickness)

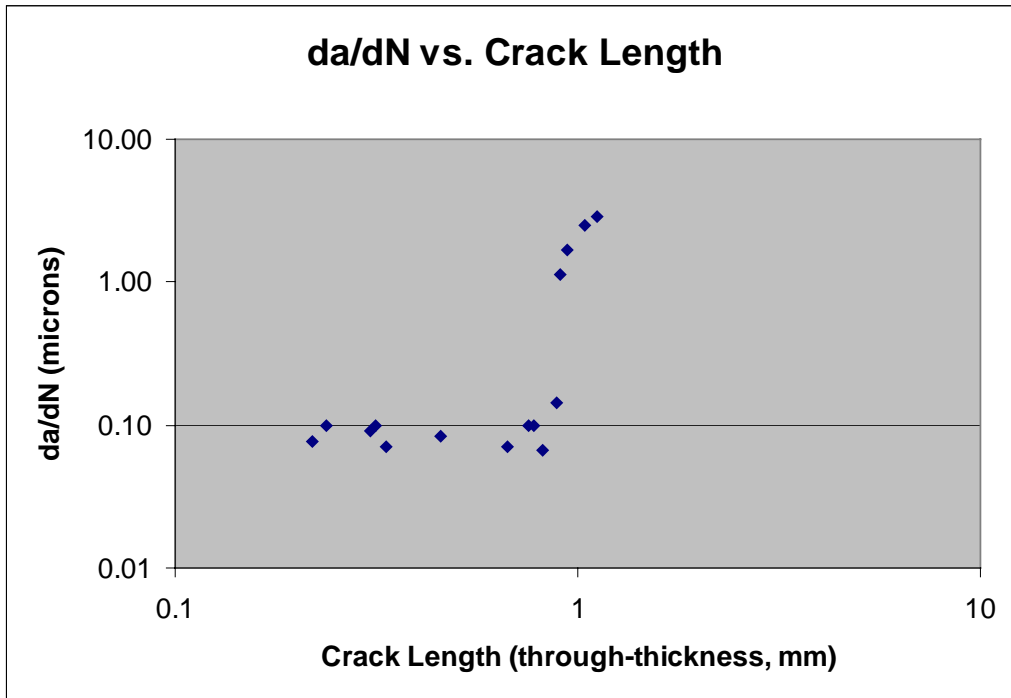

MS 22570 Appendix I

Hole #5

Cycles	Crack Length (mm)	da/dN (micron/cycle)	Photo #154	x0=1.671	y0=1.130	slope	theta (absolute)	deviation angle
	1.828415981		EOC	2.039	2.921	4.86685	1.368145	
	0.214554568	0.08333	170	2.226	1.235	0.18919	0.1869793	1.1811657
2713	0.497134683	0.12500	155	1.693	1.633	22.8636	1.5270866	0.1589416
43	0.502522298	0.12500	152	1.6709	1.643	-5130	1.5706014	0.2024564
591	0.5887145	0.16667	156	1.71	1.723	15.2051	1.5051236	0.1369786
122	0.604990884	0.10000	157	1.713	1.739	14.5	1.5019398	0.1337948
145	0.630324834	0.25000	158	1.654	1.77	-37.647	1.5442401	0.1760951
129	0.658275257	0.18182	159	1.676	1.801	134.2	1.5633449	0.1951999
257	0.702984995	0.16667	160	1.684	1.845	55	1.5526165	0.1844715
89	0.719247706	0.20000	161	1.721	1.854	14.48	1.501845	0.1337
511	0.84338029	0.28571	162	1.744	1.976	11.589	1.4847211	0.1165761
432	0.958965584	0.25000	163	1.744	2.094	13.2055	1.4952144	0.1270694
200	1.00894874	0.25000	164	1.749	2.144	13	1.4940244	0.1258794
645	1.161125817	0.22222	165	1.601	2.301	-16.729	1.5110894	0.1429444
288	1.265076451	0.50000	166	1.873	2.38	6.18812	1.4105814	0.0424364
266	1.384968752	0.40000	168	1.909	2.495	5.73529	1.3981727	0.0300277
249	1.683444595	2.00000	169	2.039	2.773	4.46467	1.3504524	0.0176925

Total between 66791st and Last

x0, y0 1.671 1.13

145Last Point to EOC
 2575Initiation to First Point
 9398Total (including extrapolation)

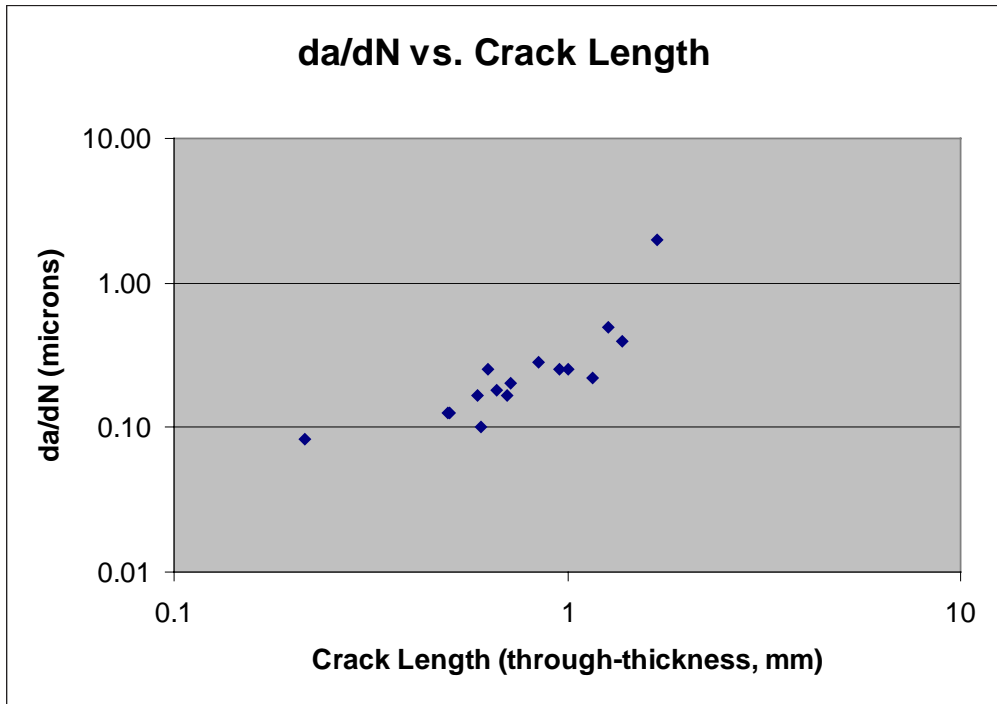

MS 22570 Appendix I

Hole #12

Cycles	Crack Length (mm)	da/dN (micron/cycle)	Photo #	x0=-19.036	y0=-19.500	slope	theta (absolute)	deviation angle
	1.921595691		EOC	-19.845	-17.757	-2.1545	1.1362441	
	0.234756459	0.25000	2	-19.111	-19.276	-2.9867	1.2477071	0.111463
322	0.30184081	0.16667	4	-19.154	-19.222	-2.3559	1.1693828	0.0331387
444	0.41279287	0.33333	5	-19.159	-19.102	-3.2358	1.271062	0.1348178
202	0.486907836	0.40000	6	-19.195	-19.037	-2.9119	1.2400021	0.103758
102	0.548358328	0.80000	7	-19.216	-18.979	-2.8944	1.2381455	0.1019013
117	0.642332831	0.80000	10	-19.241	-18.887	-2.9902	1.2480673	0.1118232
97	0.729314708	1.00000	11	-19.23	-18.786	-3.6804	1.3054926	0.1692485
102	0.848713914	1.33333	12	-19.296	-18.685	-3.1346	1.2619841	0.1257399
123	1.0074778	1.25000	13	-19.574	-18.639	-1.6004	1.0123014	0.1239427
34	1.063129986	2.00000	14	-19.592	-18.586	-1.6439	1.0242852	0.1119589
74	1.230416997	2.50000	15	-19.845	-18.519	-1.2126	0.8811934	0.2550507

Total between 16181st and Last x0, y0 -19.036 -19.5

276 Last Point to EOC
 939 Initiation to First Point
2834 Total (including extrapolation)

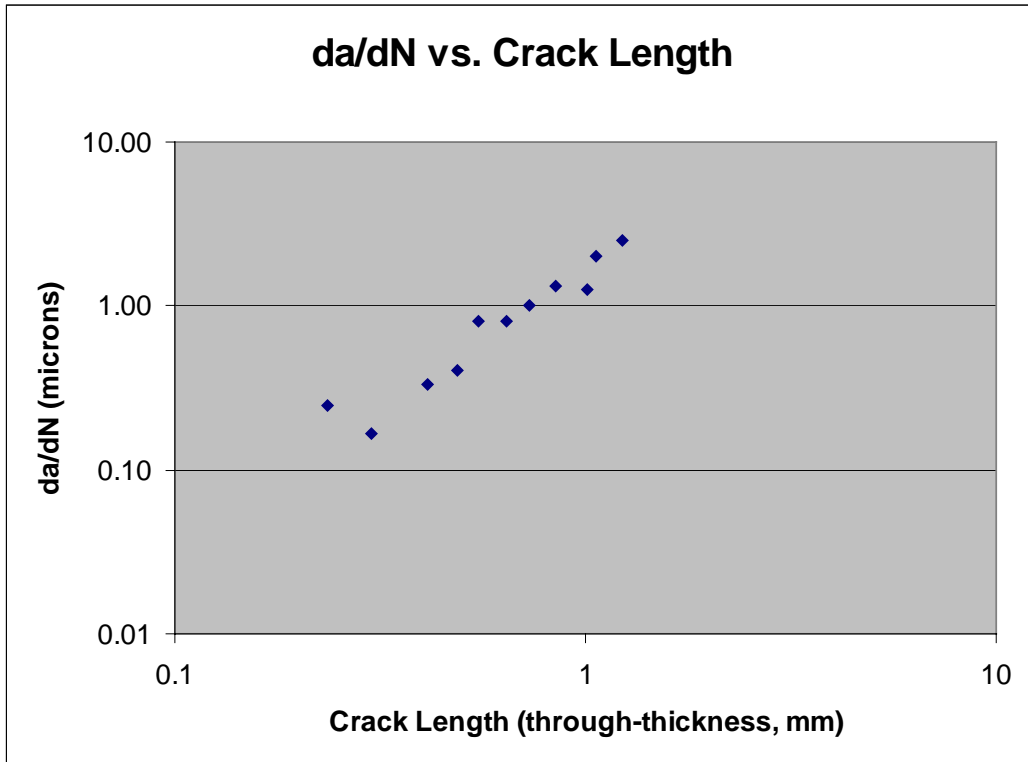

MS 22570 Appendix I

Hole #13

Cycles	Crack Length (mm)	da/dN (micron/cycle)	Photo #	x0=5.086	y0=-2.795	slope	theta (absolute)	deviation angle
	1.797220632		EOC	5.445	-1.034	4.90529	1.3696906	
	0.043691352	0.12500	24	4.985	-2.771	-0.2376	0.233297	1.1363937
1510	0.20094194	0.08333	23	4.963	-2.615	-1.4634	0.9713438	0.3983468
466	0.241515144	0.09091	22	4.961	-2.574	-1.768	1.0560469	0.3136438
242	0.262634421	0.08333	21	4.973	-2.55	-2.1681	1.1386474	0.2310432
1159	0.426819605	0.20000	20	4.931	-2.391	-2.6065	1.2044521	0.1652385
240	0.46797315	0.14286	19	4.931	-2.349	-2.8774	1.2363204	0.1333702
57	0.477771613	0.20000	18	4.931	-2.339	-2.9419	1.2431365	0.1265542
91	0.502145916	0.33333	25	5.015	-2.297	-7.0141	1.4291804	0.0594898
51	0.517796192	0.28571	28	5.074	-2.269	-43.833	1.5479866	0.178296
5	0.519631804	0.40000	26	5.055	-2.271	-16.903	1.5117049	0.1420143
67	0.544289879	0.33333	27	5.064	-2.244	-25.045	1.5308901	0.1611995
163	0.594823463	0.28571	29	5.101	-2.191	40.2667	1.545967	0.1762764
518	0.798194153	0.50000	30	5.083	-1.981	-271.33	1.5671108	0.1974202
496	1.087818582	0.66667	31	5.136	-1.695	22	1.525373	0.1556824
180	1.227972215	0.88889	32	5.249	-1.575	7.48466	1.4379764	0.0682857
176	1.376450368	0.80000	33	5.335	-1.441	5.43775	1.3889288	0.0192382

Total between 54221st and Last x0, y0 5.086 -2.795

526 Last Point to EOC
 350 Initiation to First Point
 6297 Total (including extrapolation)

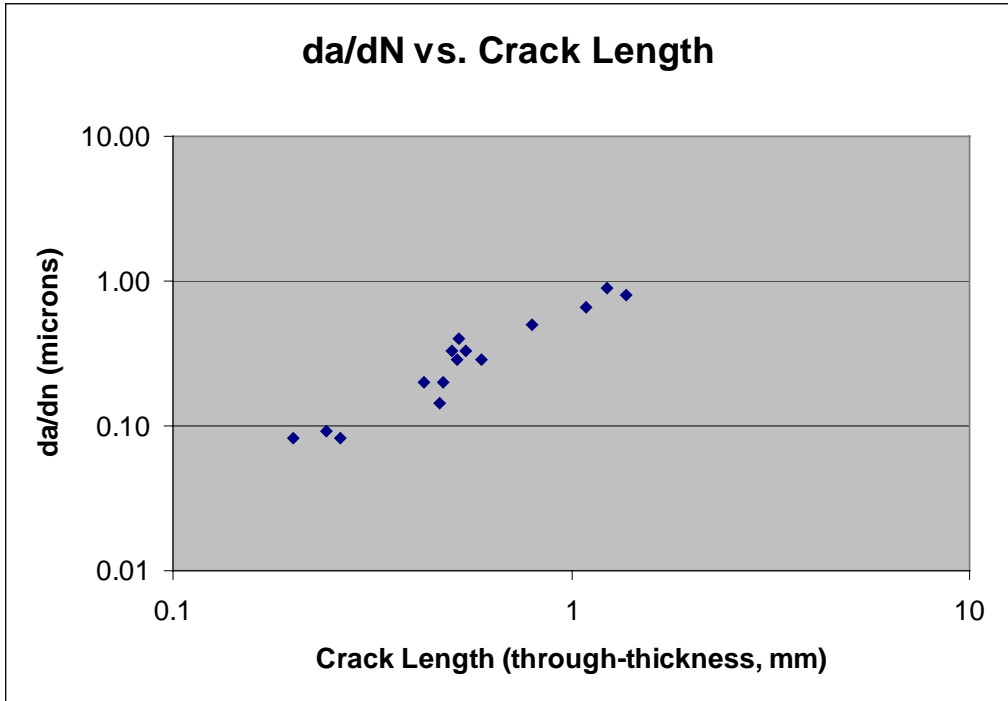

MS 22570 Appendix I

Hole #13-14

Cycles	Crack Length (mm)	da/dN (micron/cycle)	Photo	x0=15.920	y0=-6.992	slope	theta (absolute)	deviation angle
	1.797220632		EOC *	*		4.90529	1.3696906	
	0.02727378	0.11111	41	15.911	-6.966	-2.8889	1.237552	0.1321386
159	0.044967768	0.11111	42	15.944	-6.951	1.70833	1.0412067	0.3284839
369	0.096224691	0.16667	40	15.921	-6.894	98	1.5605926	0.190902
730	0.289891508	0.36364	44	15.934	-6.699	20.9286	1.5230511	0.1533605
17	0.296332009	0.40000	43	15.913	-6.691	-43	1.5475447	0.1778541
275	0.600986312	1.81818	45	16.01	-6.397	6.61111	1.4206738	0.0509832
42	0.660767509	1.00000	46	15.961	-6.326	16.2439	1.5093124	0.1396217
239	0.950667364	1.42857	47	16.029	-6.044	8.69725	1.4563201	0.0866295
206	1.355110194	2.50000	48	16.278	-5.682	3.65922	1.3040276	0.065663
5	1.368241582	2.85714	49	16.123	-5.637	6.67488	1.4220868	0.0523962
Total between 20421st and Last			x0, y0	15.92	-6.992			

150 Last Point to EOC
 245 Initiation to First Point
2438 Total (including extrapolation)

* x, y coordinates for end of cracking (EOC) was not recorded for traverse between 13 and 14. Slope and length of path at hole 13 is used as reference for this path as well

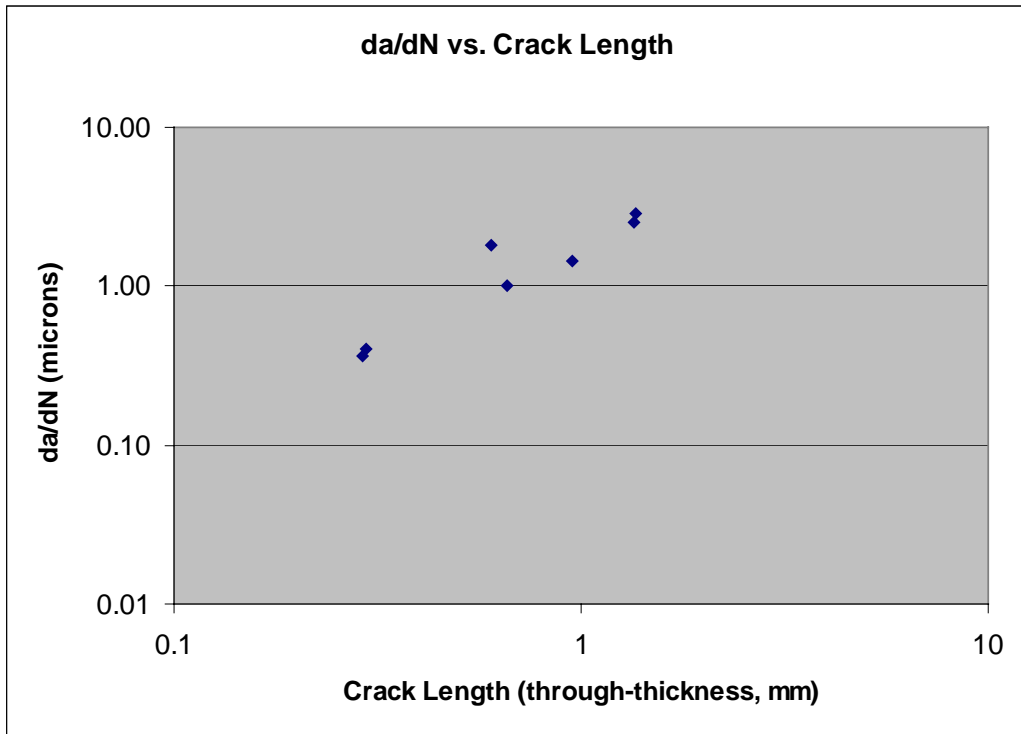

MS 22570 Appendix I

Hole #15

Cycles	Crack Length (mm)	da/dN (micron/cycle)	Photo #39	x0=-13.396	y0=1.229	slope	theta (absolute)	deviation angle
	1.768373264		EOC	-13.246	2.991	11.7467	1.4858706	
	0.206262449	0.09091	50	-13.3961	1.436	-2070	1.5703132	0.0844427
111	0.21590012	0.08333	53	-13.404	1.445	-27	1.5337762	0.0479057
2101	0.603610121	0.28571	54	-13.652	1.813	-2.2813	1.1576675	0.3282031
900	1.332083021	1.33333	55	-13.712	2.539	-4.1456	1.3340968	0.1517737
13	1.346959971	1.00000	57	-13.304	2.573	14.6087	1.5024506	0.01658
13	1.359847522	1.00000	56	-13.387	2.593	151.556	1.5641982	0.0783276

Total between 31371st and Last
 x0, y0 -13.396 1.229

409Last Point to EOC
 2269Initiation to First Point
 5815Total (including extrapolation)

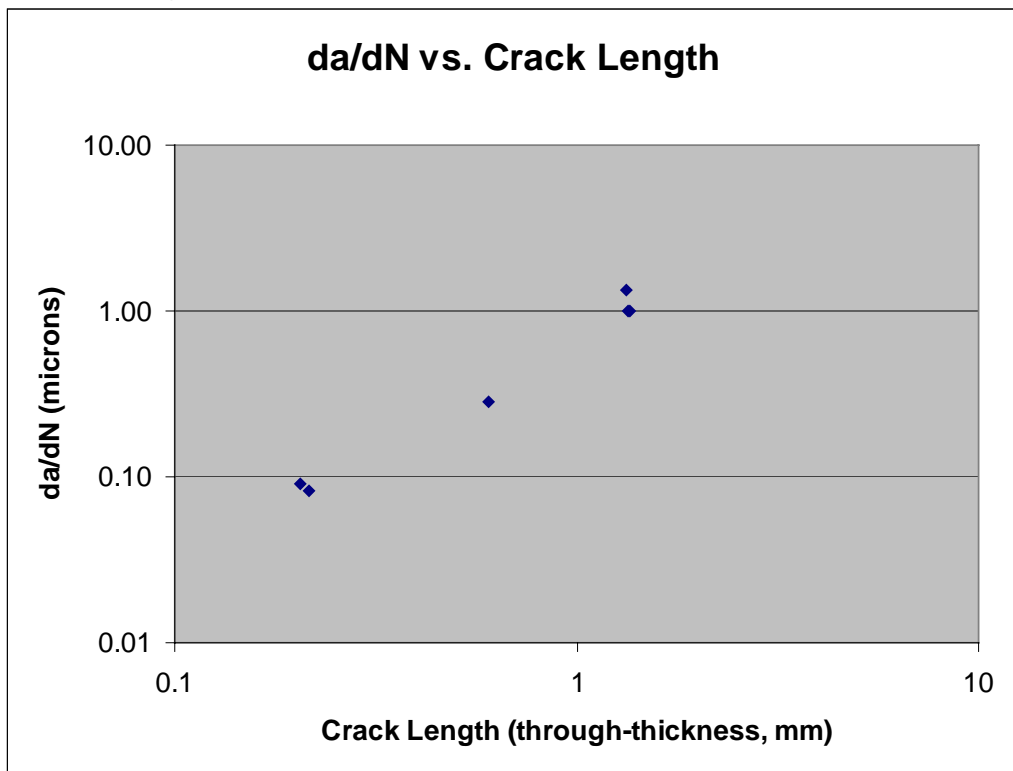

MS 22570 Appendix I

Hole #16-17

Cycles	Crack Length (mm)	da/dN (micron/cycle)	Photo #	x0=13.979	y0=-6.860	slope	theta (absolute)	deviation angle
	1.879377823		EOC	15.069	-5.329	1.40459	0.9520932	
	0.090482072	0.14286	58	13.9791	-6.749	1110	1.5698954	0.6178022
753	0.186094034	0.11111	59	14.158	-6.759	0.56425	0.5137147	0.4383785
203	0.207482495	0.10000	60	14.171	-6.742	0.61458	0.5510736	0.4010196
166	0.222712536	0.08333	61	14.179	-6.729	0.655	0.5798821	0.3722111
169	0.239102534	0.11111	62	14.189	-6.716	0.68571	0.6010738	0.3510194
738	0.548519828	0.72727	63	14.509	-6.564	0.55849	0.5093385	0.4427547
42	0.58667022	1.11111	64	14.52	-6.525	0.61922	0.5544348	0.3976584
42	0.647948478	1.81818	65	14.731	-6.6	0.34574	0.3328789	0.6192143
135	0.866433019	1.42857	66	14.89	-6.445	0.45554	0.4274542	0.524639
56	0.962263138	2.00000	67	14.801	-6.264	0.72506	0.6273481	0.3247451
74	1.159757753	3.33333	68	14.921	-6.107	0.79936	0.6743524	0.2777408
200	1.659100135	1.66667	69	14.935	-5.504	1.41841	0.9567127	0.0046195
57	1.801846313	3.33333	70	15.021	-5.39	1.41075	0.9541597	0.0020665

Total between
26331st and Last

x0, y0 13.979 -6.86

23Last Point to EOC
633Initiation to First Point
3290Total (including extrapolation)

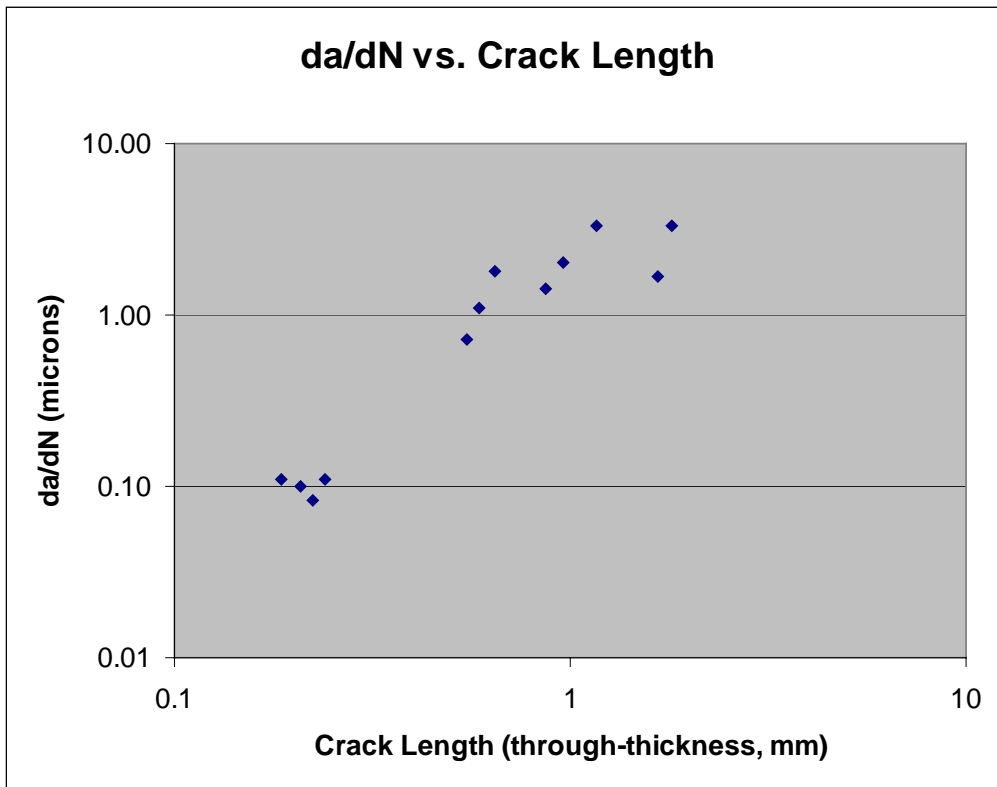

MS 22570 Appendix I

Hole #17-18

Cycles	Crack Length (mm)	da/dN (micron/cycle)	Photo #73	x0=35.713	y0=-13.901	slope	theta (absolute)	deviation angle
	1.884662569		EOC	37.066	-12.589	0.9697	0.7700148	
	0.085517165	0.09091	74	35.74	-13.806	3.51852	1.2938875	0.5238727
479	0.16368129	0.23529	75	35.781	-13.736	2.42647	1.1798845	0.4098697
100	0.18969974	0.28571	76	35.793	-13.711	2.375	1.1722739	0.4022591
87	0.219590502	0.40000	77	35.823	-13.699	1.83636	1.0721436	0.3021288
93	0.261228725	0.50000	78	35.849	-13.666	1.72794	1.0461683	0.2761536
143	0.360842843	0.88889	79	35.916	-13.592	1.52217	0.9895453	0.2195305
59	0.429674263	1.42857	80	35.976	-13.555	1.31559	0.9208526	0.1508378
344	1.247689129	3.33333	81	36.906	-13.339	0.47108	0.4402462	0.3297686

Total between 13051st and Last x0, y0 35.713 -13.901

191 Last Point to EOC
 941 Initiation to First Point
 2437 Total (including extrapolation)

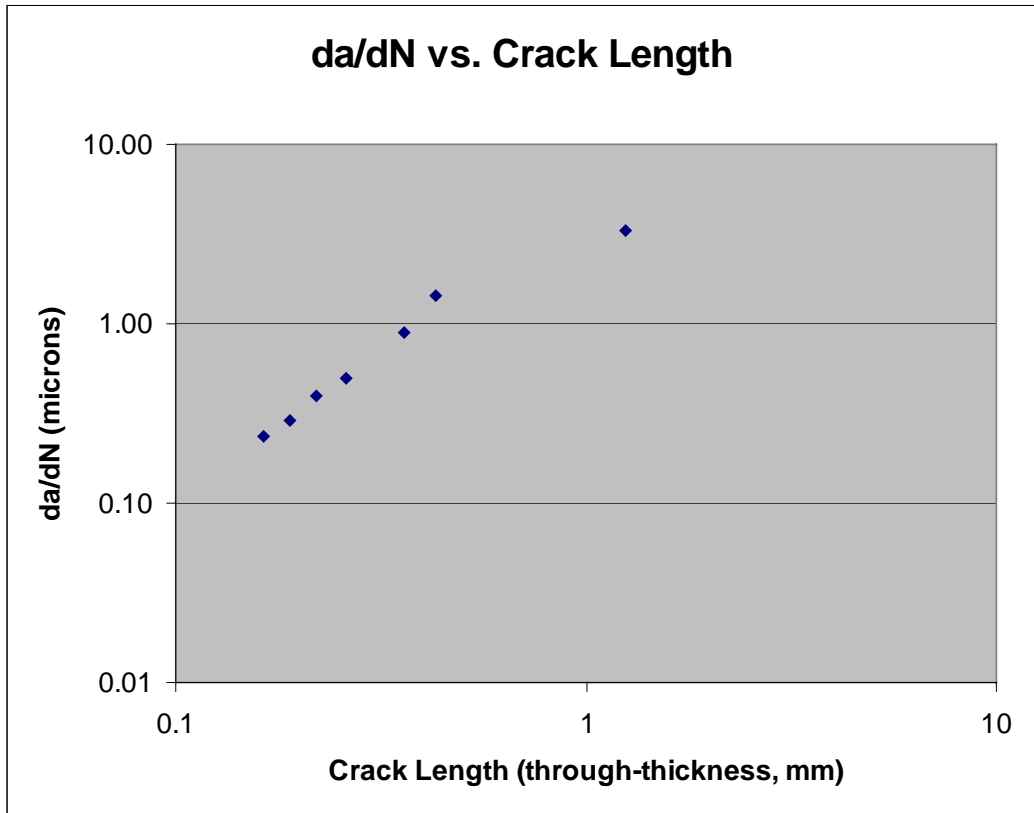

MS 22570 Appendix I

Hole #19

Cycles	Crack Length (mm)	da/dN (micron/cycle)	Photo #228	x0=-1.41 y0=-2.202	slope	theta (absolute)	deviation angle
	1.767900733		EOC	-2.577	-0.874	-1.138	0.8498379
	0.319586383	0.16667	230	-1.629	-1.969	-1.0639	0.8163617
126	0.338002009	0.12500	229	-1.6	-1.919	-1.4895	0.9795391
564	0.443756816	0.25000	231	-1.676	-1.845	-1.3421	0.9304399
166	0.48513923	0.25000	232	-1.7	-1.811	-1.3483	0.9326362
271	0.552881156	0.25000	233	-1.715	-1.734	-1.5344	0.9932204
871	0.71624836	0.12500	234	-1.81	-1.6	-1.505	0.9843286
540	0.803999327	0.20000	235	-1.795	-1.47	-1.9013	1.0866
343	0.855488644	0.10000	236	-1.807	-1.412	-1.9899	1.1051255
2805	1.151581626	0.11111	238	-2.152	-1.321	-1.1873	0.8708336
79	1.160892103	0.12500	237	-2.124	-1.284	-1.2857	0.9097532
652	1.388063229	0.57143	239	-2.236	-1.08	-1.3584	0.9361954
Total between 64181st and Last			x0, y0	-1.41	-2.202		

665 Last Point to EOC
 1918 Initiation to First Point
 9000 Total (including extrapolation)

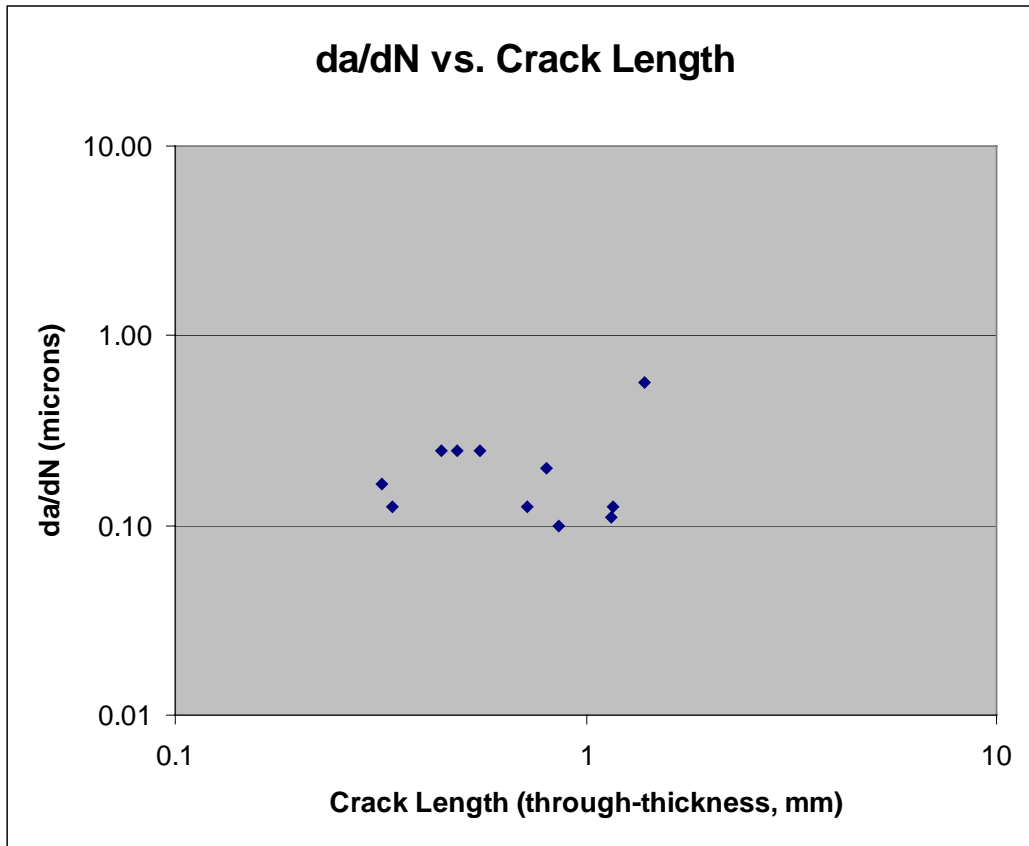

MS 22570 Appendix I

Hole #21

Cycles	Crack Length (mm)	da/dN (micron/cycle)	Photo #101	x0=32.938	y0=2.231	slope	theta (absolute)	deviation angle
	2.006024177		EOC	32.811	4.233	-15.764	1.5074447	
	0.155177093	0.14286	102	32.993	2.383	2.76364	1.2236109	0.2838337
60	0.161593267	0.07143	104	32.984	2.39	3.45652	1.2891772	0.2182675
16	0.162859453	0.08333	103	33.004	2.39	2.40909	1.1773457	0.330099
69	0.16764454	0.05556	105	32.985	2.396	3.51064	1.2932973	0.2141473
1082	0.246850963	0.09091	106	32.975	2.476	6.62162	1.4209086	0.0865361
105	0.256019347	0.08333	111	33.041	2.481	2.42718	1.1799881	0.3274565
440	0.296370805	0.10000	107	32.969	2.526	9.51613	1.4660958	0.0413488
641	0.374214333	0.14286	108	32.969	2.604	12.0323	1.487877	0.0195677
294	0.416256698	0.14286	109	32.971	2.646	12.5758	1.4914452	0.0159994
1070	0.559614392	0.12500	110	33.06	2.784	4.53279	1.3536597	0.153785
3024	1.050943964	0.20000	112	32.811	3.276	-8.2283	1.4498583	0.0575863
413	1.133602489	0.20000	113	32.798	3.358	-8.05	1.4472059	0.0602388
1038	1.533946617	0.57143	114	32.906	3.766	-47.969	1.5499524	0.0425078
Total between 82531st and Last				x0, y0	32.938	2.231		

826Last Point to EOC
 1086Initiation to First Point
10165Total (including extrapolation)

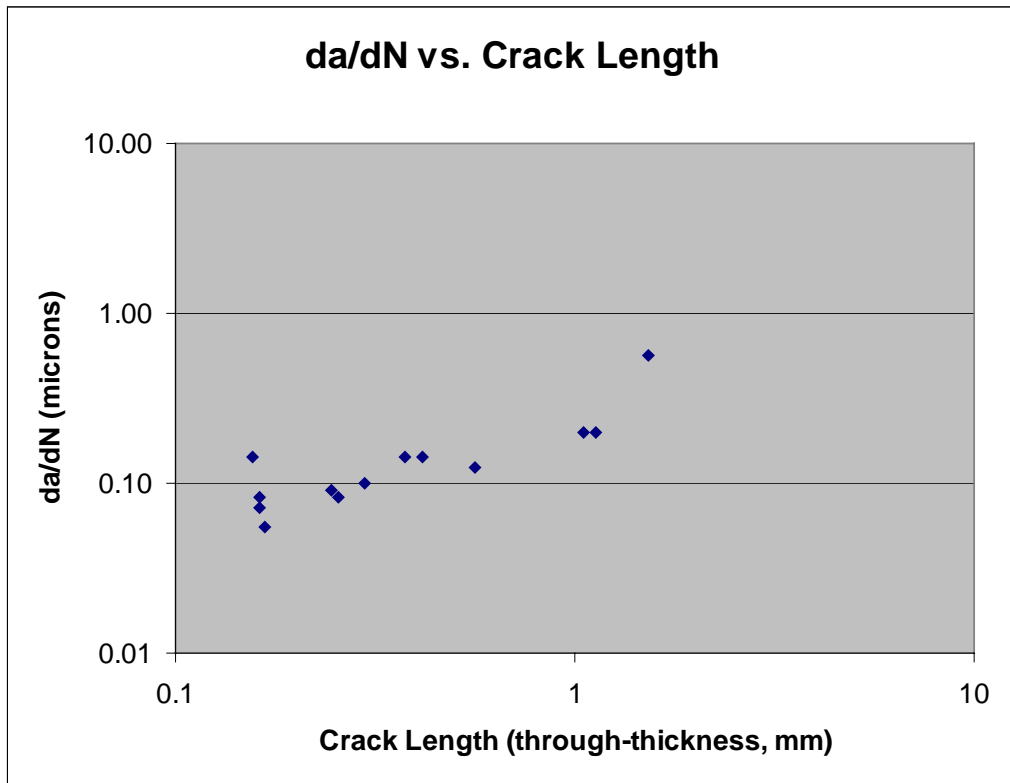

MS 22570 Appendix I

Hole #23

Cycles	Crack Length (mm)	da/dN (micron/cycle)	Photo #130	x0=1.903	y0=-0.774	slope	theta (absolute)	deviation angle
	1.807458437		EOC	2.244	1.001	5.20528	1.3809961	
	0.120702637	0.08333	131	2.168	-0.702	0.2717	0.2652939	1.1157022
2227	0.324889905	0.10000	132	2.178	-0.496	1.01091	0.7908231	0.590173
236	0.349756867	0.11111	128	1.909	-0.419	59.1667	1.5538965	0.1729004
582	0.408552133	0.09091	133	2.179	-0.411	1.31522	0.9207164	0.4602797
3320	0.743945738	0.11111	134	2.239	-0.081	2.0625	1.1193432	0.2616529
704	0.841777586	0.16667	135	2.211	0.024	2.59091	1.2024474	0.1785487
718	0.991342851	0.25000	136	2.249	0.169	2.72543	1.2191334	0.1618627
1227	1.417370352	0.44444	137	2.196	0.613	4.73379	1.3626098	0.0183863
52	1.454687946	1.00000	138	2.196	0.651	4.86348	1.3680085	0.0129876

Total between 9066 1st and Last

x0, y0 1.903 -0.774

353 Last Point to EOC

1448 Initiation to First Point

10868 Total (including extrapolation)

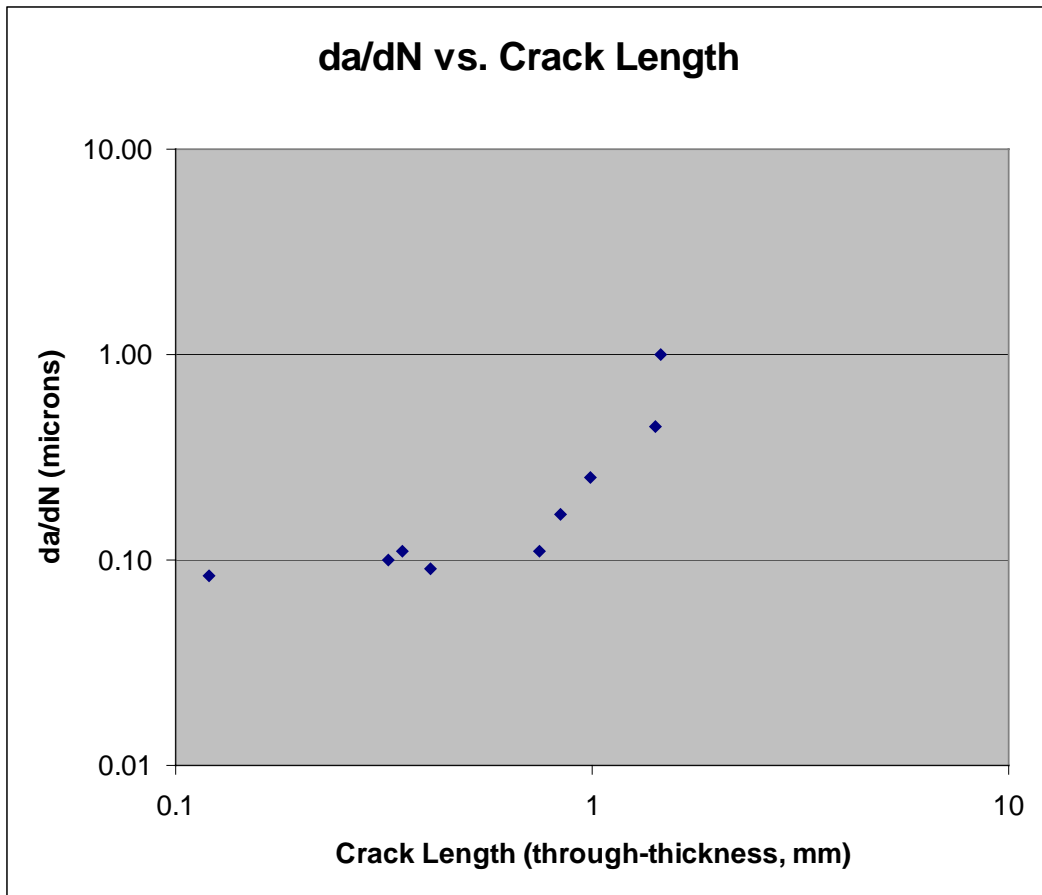

MS 22570 Appendix I

Hole #25

Cycles	Crack Length (mm)	da/dN (micron/cycle)	Photo #142	x0=3.578	y0=1.068	slope	theta (absolute)	deviation angle
	1.83623773		EOC	3.941	2.868	4.95868	1.3717987	
	0.236263689	0.111111	140	3.5781	1.309	2410	1.5703814	0.1985827
441	0.294697136	0.15385	139	3.596	1.365	16.5	1.5102643	0.1384656
234	0.332144902	0.16667	143	3.559	1.403	-17.632	1.5141406	0.1423419
174	0.361157485	0.16667	144	3.595	1.433	21.4706	1.5242546	0.1524559
315	0.444684251	0.36364	145	3.72	1.493	2.99296	1.2483401	0.1234587
141	0.563962924	1.33333	146	3.768	1.605	2.82632	1.2307247	0.141074
79	0.682674678	1.66667	147	3.709	1.738	5.1145	1.3777098	0.0059111
121	0.935181198	2.50000	148	3.573	2.021	-190.6	1.5655498	0.1937511
91	1.149870883	2.22222	149	3.5781	2.241	11730	1.5707111	0.1989124
42	1.238890239	2.00000	150	3.559	2.328	-66.316	1.5557181	0.1839194
106	1.496837232	2.85714	151	3.801	2.55	6.64574	1.4214445	0.0496458
Total between 17441st and Last			x0, y0	3.578	1.068			

119Last Point to EOC
 2126Initiation to First Point
 3989Total (including extrapolation)

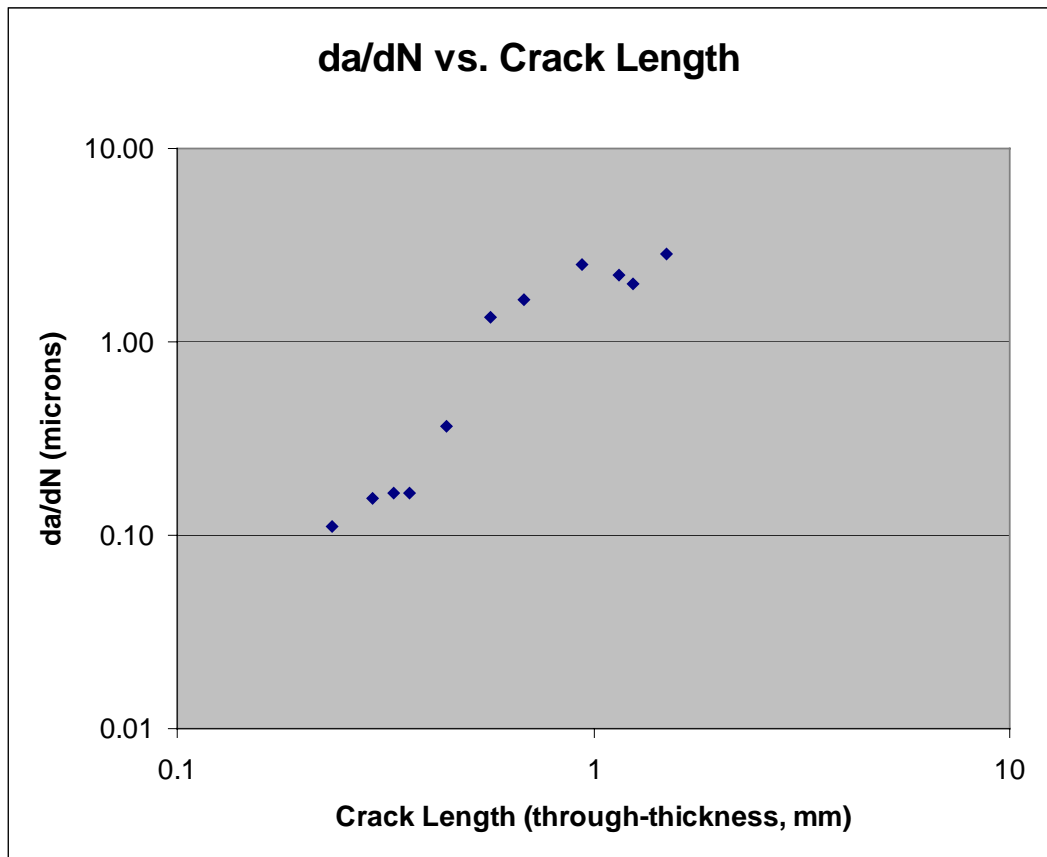

MS 22570 Appendix I

Hole #27

Cycles	Crack Length (mm)	da/dN (micron/cycle)	Photo	#175x0=-7.440y0=-1.291	slope	theta (absolute)	deviation angle
	1.765007082		EOC	-7.705	0.454	-6.5849	1.4200854
	0.299429393	0.14286	192	-7.742	-1.034	-0.851	0.7150149
1587	0.500952664	0.11111	191	-7.787	-0.837	-1.3084	0.5018904
788	0.623521577	0.20000	190	-7.8	-0.715	-1.6	0.4078884
16	0.626762358	0.20000	189	-7.815	-0.714	-1.5387	0.4256034
790	0.762246233	0.14286	188	-7.835	-0.58	-1.8	0.3563876
66	0.77720368	0.30769	187	-7.77	-0.555	-2.2303	0.2707863
101	0.802784314	0.20000	186	-7.756	-0.527	-2.4177	0.2414751
573	0.931761134	0.25000	185	-7.759	-0.397	-2.8025	0.1920295
126	0.958993319	0.18182	184	-7.756	-0.369	-2.9177	0.1794755
272	1.017701299	0.25000	183	-7.719	-0.304	-3.5376	0.1247764
323	1.079536745	0.13333	182	-7.716	-0.241	-3.8043	0.1063315
128	1.098760464	0.16667	180	-7.686	-0.217	-4.3659	0.0744553
42	1.108346827	0.28571	181	-7.684	-0.207	-4.4426	0.0706913
73	1.126882164	0.22222	179	-7.656	-0.184	-5.125	0.0419898
79	1.15315118	0.44444	178	-7.64	-0.155	-5.68	0.0235595
182	1.216275573	0.25000	177	-7.639	-0.091	-6.0302	0.0136268
9	1.218465366	0.25000	176	-7.647	-0.09	-5.8019	0.0199685
307	1.512325376	1.66667	193	-7.609	0.213	-8.8994	0.0388133
Total between 54621st and Last			x0, y0	-7.44	-1.291		

152 Last Point to EOC
 2096 Initiation to First Point
 7710 Total (including extrapolation)

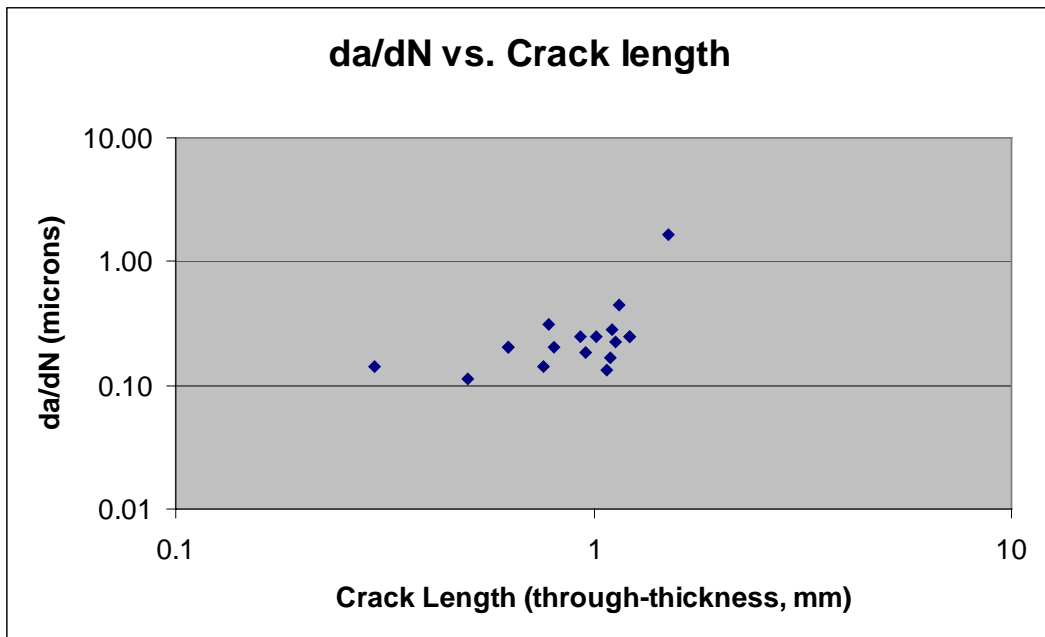

附錄 17 第 640 號殘骸之複驗報告

INTRODUCTION

A further examination of the doubler faying surface (between holes +16 and 49) was deemed necessary in order to ascertain whether the scratch/scrape markings (on the surface of the doubler which overlapped the un-recovered skin segment) could be characterized as cyclic hoop-wise rubbing (fretting), or as a scrape resulting from a single contact; to this end, the item in question was again examined at CSIST by a team consisting of CAA, ASC and CAL (Boeing and NTSB declined the invitation to attend), on September 14th 2004.

RESULTS

Markings adjacent to hole 32

The surface markings near hole 32 were examined and the findings are as follows:

- (1) The surface markings near hole 32 are presented in Figure 1, and an optically magnified photograph of the subject area is shown in Figure 2. Figure 1 shows that the surface markings at the suspected area of contact exhibit many colors. Figure 2 shows that some hoop-wise scratches (marked by arrows) were visible on the surface of the suspected area of contact.
- (2) Figure 3 is an SEM photograph at point A in figure 2, indicating that the grooves of the scratches were covered by some material(s).
- (3) Two cross section locations were chosen to characterize the surface markings. Figures 5 and 6 are the metallographic photographs through the area marked by the data sampling cut #1 and data sampling cut #2 respectively, shown in Figure 4, showing that there was some material superimposed over the grooves of the scratches.

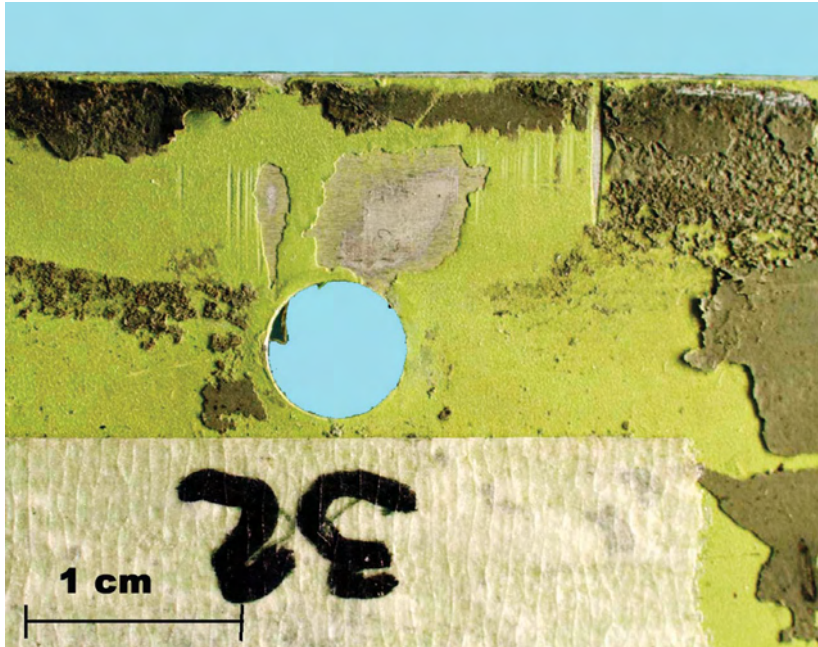

Figure 1, Surface markings adjacent to hole 32, showing the different colors on the metal surface.

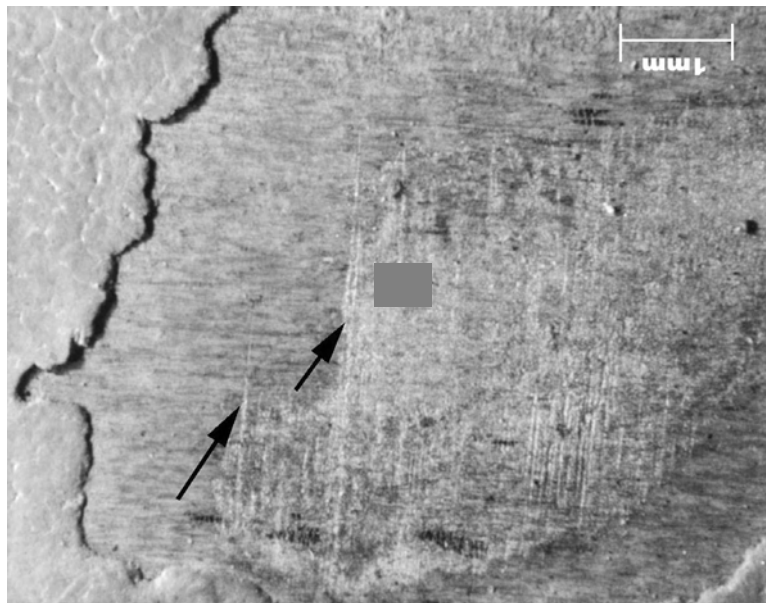

Figure 2, Optical magnification photograph of the marking area in Figure 1.

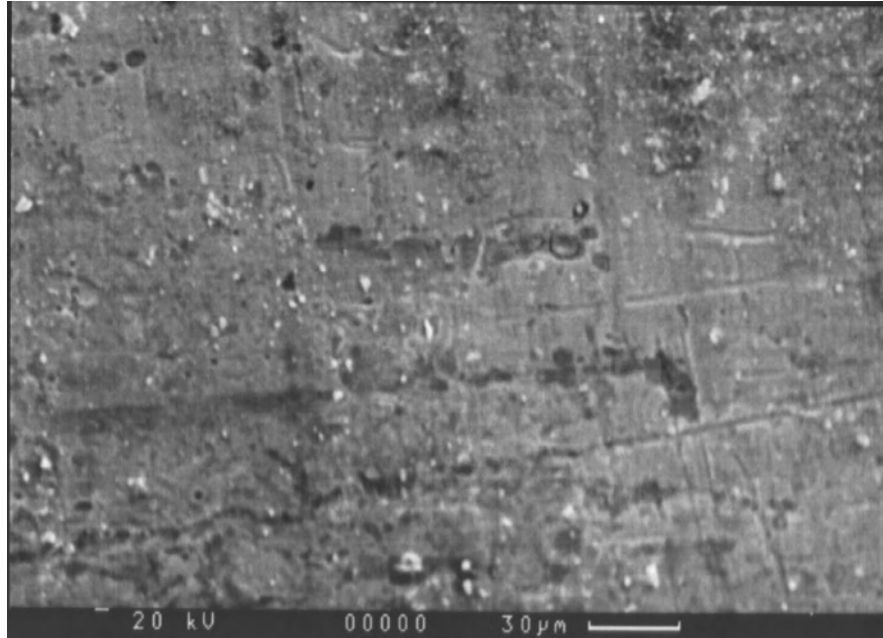

Figure 3, SEM photograph at point A in figure 2, indicating that the grooves of some of the scratches were covered by some material.

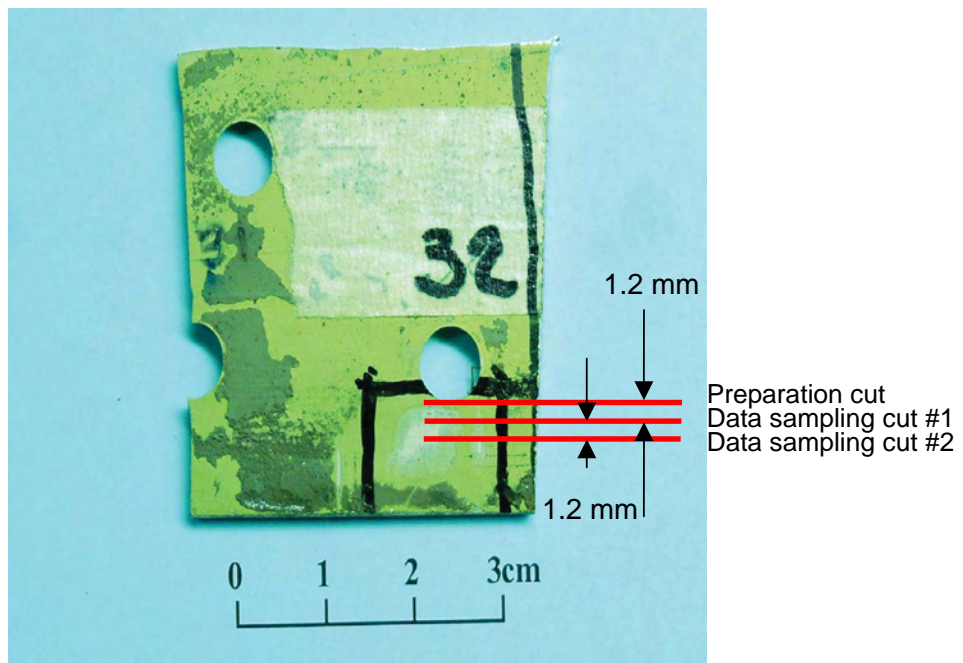

Figure 4, Cross section locations - taken to characterize the surface marking contours.

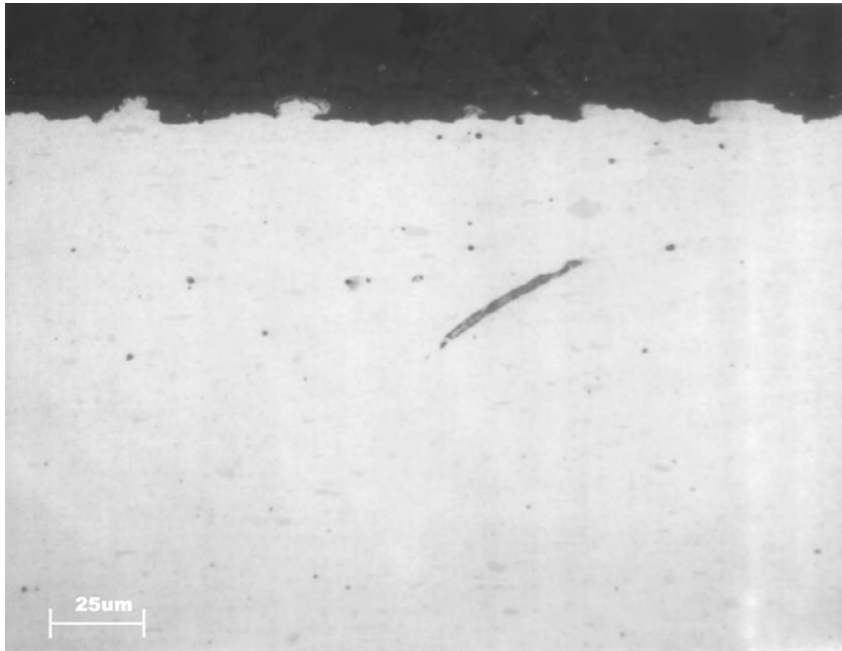

Figure 5, Metallographic photo through the area marked by the data sampling cut #1 in Figure 4.

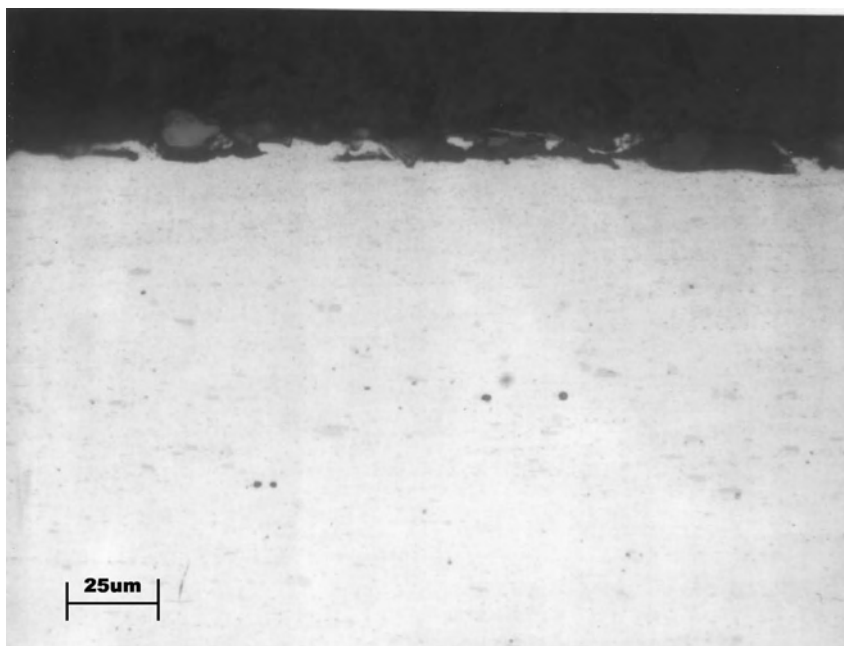

Figure 6, Metallographic photo through the area marked by the data sampling cut #2 in Figure 4.

Markings adjacent to holes 11, 49 and +16.

Marking areas of interest adjacent to holes 11, 49 and +16 are shown in Figure 7, 8, 9, respectively; all showing scrape/scratch marks on the surface.

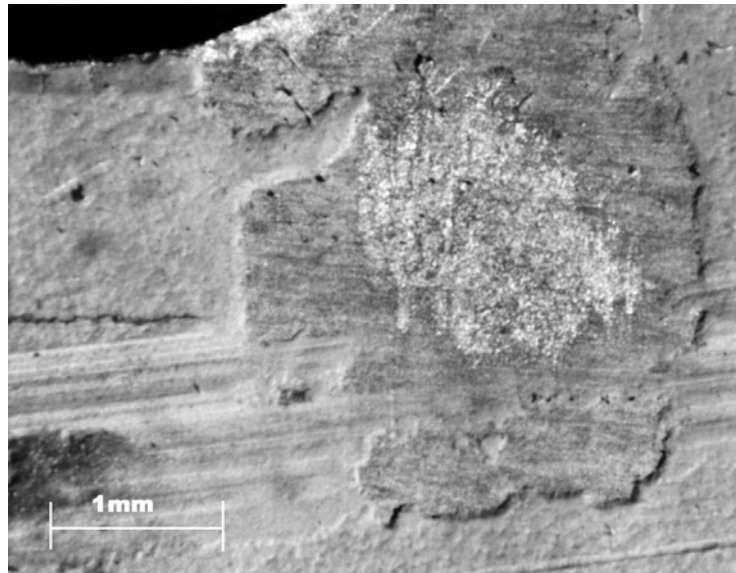

Figure 7 Surface area adjacent to hole 11.

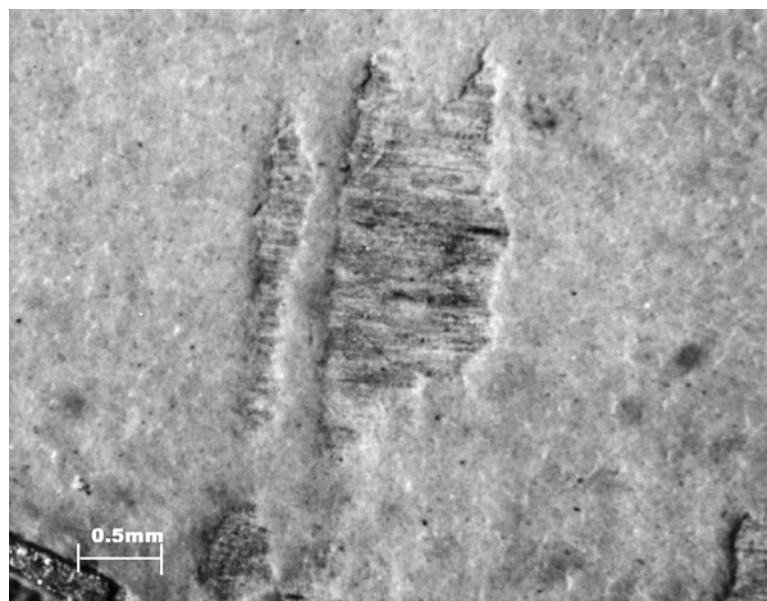

Figure 8 Surface area adjacent to hole 49

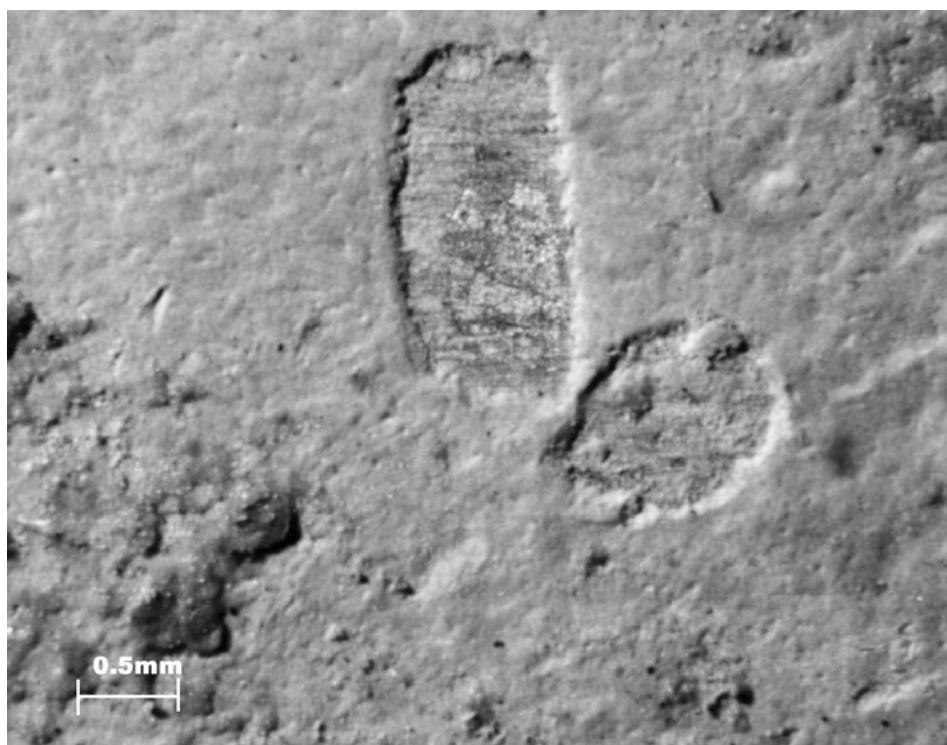

Figure 9 Surface area adjacent to hole +16

附錄 18 裂痕傳遞方向判定方法

The profiles of the skin fractures were examined to determine the direction of fracture propagation. This appendix describes the methodology that was used. Fracture directions were based on hole-to-hole cracking patterns, chevron marks, and branching cracks.

Net Section Tension

- Fairly straight hole-to-hole fracture – No directionality
- Evidence of flat fracture features could be slow growth regions



Rapid Separation by Tension or Shear

- Fracture forms a distinctive “hook” as it links with the next hole
- Slant fracture with no flat features



Typical of Initiation and Propagation by Net Tension

- Initiation in straight region
- Propagation in both directions beyond straight fracture



Evidence of flat fracture features could be slow growth in straight region otherwise will have slant fracture features

Tearing

- Fracture profile along fastener line may not provide evidence of

directionality

- Signs of sheet and other structure deformation may aid in determining propagation direction
- Slant fracture with no flat features

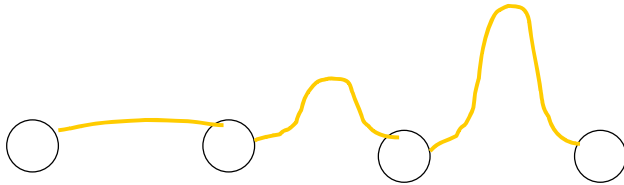

Example of various profiles with no clear indication of direction

Macroscopic Fracture Features – “Chevron Marks”

- “Chevron Marks” point back to the origin and indicate the direction of fracture propagation. (Ref. ASM Metals Handbook, Volume 12)
- More evident on thicker structure (e.g. major fittings)

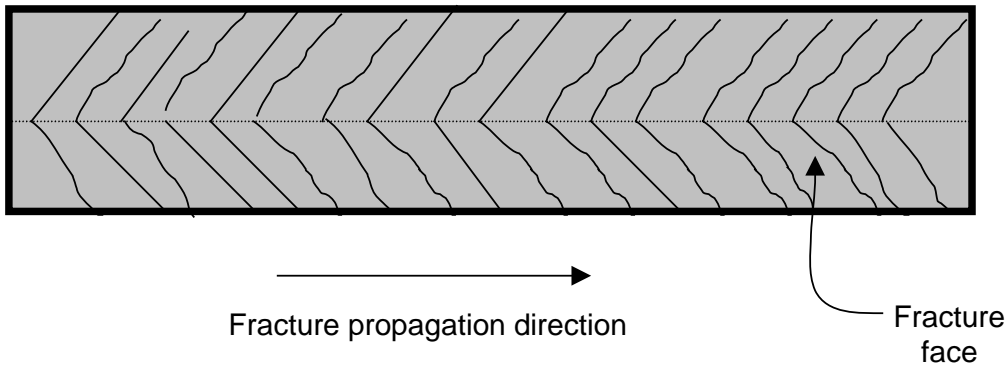

Item 640 S-49L, STA 2100



Multiple crack initiation sites along length



Item 738 S-27L, STA 1620



Propagation direction



Item 633 STA 2360 Skin ~ S-2R



Propagation direction



Item 738 S-14L, STA 1800 - 1820



No obvious directionality – formed by tearing action
 Displacement in panel may assist in determining directionality



Item 652 STA 460



No apparent directionality in this local area

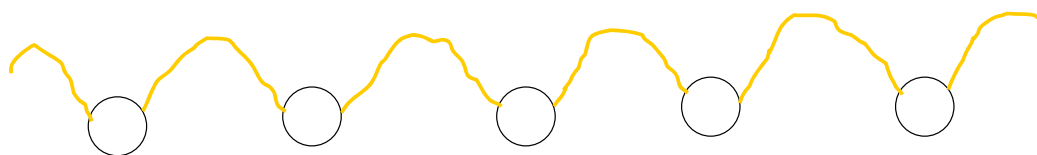

附錄 19 照明建議規範

Recommended levels for office lighting have dropped dramatically in the past 25 years. In 1970, 100 maintained foot-candles (fc) was the preferred illumination level. Today, Illuminating Engineering Society of North America (IESNA) maintains that 30-50 fc will fit the bill for most modern offices.

Of course, this new recommendation doesn't mean we're all being left in the dark. The level reduction suggested by IESNA simply reflects changes in office technology, work methods, and careful reevaluation by IESNA. Clean, high-contrast, laser-printed type has superceded drafts with a number three pencil on purple mimeograph sheets. Computer screens have replaced drafting tables. Lower illumination levels, such as those specified in *Office Lighting* (ANSI/IESNA RP-1), are more suited for the demands of VDT viewing, which include good control of surrounding and reflected luminances and luminance ratios. Task lighting can provide an additional boost in specific locations where difficult tasks are performed.

Cost and Energy Savings

Savings go hand in hand with the aesthetic and functional benefits of lower overall ambient illumination levels. Direct savings from lower lighting energy use are supplemented by reduced air conditioning costs: because lights are producing less heat, air conditioners don't have to work as hard. These air conditioning savings are typically equivalent to 10-30% of the lighting energy savings.

The Basis for Recommended Illumination Levels

Illumination levels recommended by IESNA represent a consensus of expert opinion on the quantity of illuminance required to perform specific tasks with comfort and accuracy. Although research to establish illuminance recommendations based on human performance is proceeding, a generally accepted system is not yet available.

Establishing Proper Illumination Levels

To guide the process of establishing the proper illumination level for your workplace, IESNA has established an illuminance specification procedure. This procedure--outlined in chapter 11 of its *Lighting Handbook*, and summarized in the tables in this bulletin--recommends adjusting the

illumination level according to the many factors that can affect visual performance.

Table 1 defines the nine illuminance categories (A through I), while Table 1a shows some common tasks and appropriate illuminance categories. Each category then recommends a range of three appropriate illumination levels, expressed in footcandles. To choose the appropriate level for a particular application, several situational variables (weighing factors) must be considered.

Table 1: Illuminance Categories			
Illuminance Category	Activity Type	Footcandle Range	Workplane Reference
A	Public Space, dark surroundings	2-3-5	General lighting throughout space
B	Simple orientation, short temporary visit	5-7.5-10	"
C	Visual tasks only occasionally performed	10-15-20	"
D	High contrast or large tasks	20-30-50	Illuminance on task
E	Medium contrast or small tasks	50-75-100	"
F	Low contrast or very small tasks	100-150-200	"
G	Low contrast or very small tasks for a prolonged period	20-300-500	Illuminance on task, both general and supplementary components
H	Very prolonged and exacting tasks	500-750-1000	"
I	Extremely low contrast and small very special tasks	1000-1500-2000	"

Table 1a. Recommended Illumination Levels

Task		IESNA Illuminance Category	Recommended Footcandles*
Drafting	High contrast (ink, soft lead)	E	50-75-100
	Low contrast (hard lead)	F	100-150-200
Inspection	Simple	D	20-30-50
	Moderate	E	50-75-100
	Difficult	F	100-150-200
Machine Work	Medium, grinding, etc.	E	50-75-100
Materials Handling	Picking, packing, wrapping, labeling	D	20-30-50
Other	Lobby, corridor, waiting area	C	10-15-20
	Toilets, rest rooms	C	10-15-20
	Teller stations, ticket counters	E	50-75-100
Reading	General	D	20-30-50
	Soft pencil (#2), pen, good copies, keyboards, > 8 pt. type	D	20-30-50
	Hard pencil (#3), phone books, poor copies, < 8 pt. type	E	50-75-100
Schools	Science laboratories	E	50-75-100
Storage	Inactive	B	5-7.5-10
	Active, large items	C	10-15-20
	Active, small items	D	20-30-50
*See <u>Table 2</u> for weighting factors used to determine which of the three designated levels to choose.			

*See Table 2 for weighting factors used to determine which of the three designated levels to choose.

Table 2 indicates how to apply these weighting factors. For categories A-C, the table provides general illuminances (ambient light levels throughout the room), based on two weighting factors: occupant age and background reflectance. For categories D-I, it provides illuminances on the task, and adds a third weighting factor for speed and accuracy. The *Lighting Handbook* also shows a

method to add weighting factors together to achieve the results shown in this table.

Using these tables, it is possible to evaluate the lighting requirements of, for example, the work space of an editor working for a busy daily newspaper. The first step involves defining variables: The editor is over 55, works in an office, is under constant daily deadline pressure, and works alternately between a VDT terminal and printed pages with 10-point type and handwritten corrections.

Next, the physical work space should be evaluated. Table 1a places typical office tasks in illuminance category D (reading good copies, soft pencil, keyboard). Weighting factors in Table 2 (over 55 years old, critical speed and accuracy, 75% task background reflectance) indicate that this work area needs 30 footcandles illuminance on the task.

Table 2. Determining Illuminance Values				
a. General Lighting Throughout Room (footcandles)				
Weighting Factors		Illuminance Categories		
Average of Occupants' Ages	Average Room Surface Reflectance (Percent)	A	B	C
Under 40	Over 70	2	5.0	10
	30-70	3	7.5	15
	Under 30	3	7.5	15
40-55	Over 70	3	7.5	15
	30-70	3	7.5	15
	Under 30	3	7.5	15
Over 55	Over 70	3	7.5	15
	30-70	3	7.5	15
	Under 30	5	10.0	20
b. Illuminance on Task (footcandles)				

Weighting Factors			Illuminance Categories						
Average of Workers' ages	Demand for Speed and/or Accuracy*	Task Background Reflectance (Percent)	D	E	F	G**	H**	I	I**
Under 40	NI	Over 70	20	50	100	200	500	1000	
		30-70	20	50	100	200	500	1000	
		Under 30	30	75	150	300	750	1500	
	I	Over 70	20	50	100	200	500	1000	
		30-70	30	75	150	300	750	1500	
		Under 30	30	75	150	300	750	1500	
	C	Over 70	30	75	150	300	750	1500	
		30-70	30	75	150	300	750	1500	
		Under 30	30	75	150	300	750	1500	
40-55	NI	Over 70	20	50	100	200	500	1000	
		30-70	30	75	150	300	750	1500	
		Under 30	30	75	150	300	750	1500	
	I	Over 70	30	75	150	300	750	1500	
		30-70	30	75	150	300	750	1500	
		Under 30	30	75	150	300	750	1500	
	C	Over 70	30	75	150	300	750	1500	
		30-70	30	75	150	300	750	1500	
		Under 30	50	100	200	500	1000	2000	
Over 55	NI	Over 70	30	75	150	300	750	1500	
		30-70	30	75	150	300	750	1500	
		Under 30	30	75	150	300	750	1500	
	I	Over 70	30	75	150	300	750	1500	
		30-70	30	75	150	300	750	1500	
		Under 30	50	100	200	500	1000	2000	
	C	Over 70	30	75	150	300	750	1500	
		30-70	50	100	200	500	1000	2000	

		Under 30	50	100	200	500	1000	2000
* NI = Not Important, I = Important, and C = Critical ** Obtained by a combination of general and supplementary lighting.								

Remember that the recommended illumination levels are "maintained." This means that in spite of all conditions, such as dirt accumulation and lamp lumen depreciation, the recommended illumination level is the minimum for proper work conditions.

The IESNA recommends the following illumination levels for specific tasks. For a more precise description and detailed discussion of these and other areas, see the *Lighting Handbook*.

Checking Existing Illumination Levels

To check how closely existing illumination levels meet recommended levels, a lighting survey should be performed. Chapter 2 of the *Lighting Handbook* provides guidance. Almost any calibrated light meter (with cosine and photopic response correction) can be used for a rough check (plus or minus 25%), but if accuracy is important, the meter should be able to provide precise measurements. For assistance in selecting a light meter, refer to "1994 IESNA Survey of Illuminance and Luminance Meters," *Lighting Design + Application*, Vol. 24, No. 6, June 1994, p. 31, IESNA, New York, NY.

Technical Terms

- Illumination level or illuminance: density of luminous flux incident on a surface. This basic lighting parameter is expressed in footcandles or lux (a number about 10 times as large as the equivalent footcandle measurement).
- Illuminance category: One of a set of categories developed by IESNA to group tasks according to illuminance requirements. Each category is designated by one of nine letters.
- Workplane: the location where a task is performed; usually related to the distance from a light source(s).
- Luminance: the luminous intensity of a source per unit area in a given direction; often mistakenly called "brightness."

- Cosine response: correction to a photo detector that simulates the human eye's response to the angular location of a light source from the "straight ahead" position.
- Photopic response: correction to a photo detector that simulates the human eye's response to colors and colored light combinations.
- Luminance ratio: the ratio between the luminances of any two areas in the visual field.

References

- Illuminating Engineering Society of North America (IESNA), Lighting Handbook, Eighth Edition, New York, NY, 1993.
- IESNA, Office Lighting, ANSI/IESNA RP-1-1993, New York, NY, 1993.
- EPRI, Lighting Fundamentals Handbook, TR-10710, Palo Alto, CA, 1993.
- EPRI, Advanced Lighting Guidelines: 1993, TR-101022R1, Palo Alto, CA, 1993.
- IESNA, Nomenclature and Definitions for Illuminating Engineering, ANSI/IESNA RP-16-1986, New York, NY, 1986.

國家圖書館出版品預行編目資料

飛航事故調查報告：中華民國 91 年 5 月 25 日,中華航空公司 CI611 班機, BOEING747-200 型機,國籍標誌及登記號碼 B-18225,於澎湖縣馬公市東北 23 哩處之台灣海峽上空空中解體／行政院飛航安全委員會編著. -- 臺北市：飛安委員會, 民 94
面； 公分

ISBN 986-00-1351-9 (第 2 冊:平裝)

1. 航空事故 - 調查 2. 飛行安全

557.909

94010094

飛航事故調查報告

中華民國 91 年 5 月 25 日,中華航空公司 CI611 班機, BOEING747-200 型機,國籍標誌及登記號碼 B-18225,於澎湖縣馬公市東北 23 哩處之台灣海峽上空空中解體

編著者：行政院飛航安全委員會

出版機關：行政院飛航安全委員會

電話：(02) 25475200

地址：台北市松山區 105 復興北路 99 號 16 樓

網址：<http://www.asc.gov.tw>

出版年月：中華民國 94 年 6 月 (初版)

經銷處：三民書局：台北市重慶南路一段 62 號

五南文化廣場：台中市中山路 6 號

新進圖書廣場：彰化市中正路二段 5 號

青年書局：高雄市青年一路 141 號

國家書坊台視總店：台北市八德路三段 10 號

國家書坊網路書店：台北市瑞光路 583 巷 25 號

GPN：1009401587

ISBN：986-00-1351-9

定價：新台幣 1030 元

出版品內容可至上開網址「出版品與著作」中全文下載