



# **Aviation Occurrence Report Volume I**

ASC-AOR-05-02-001

**IN-FLIGHT BREAKUP OVER THE TAIWAN STRAIT**

**NORTHEAST OF MAKUNG, PENGHU ISLAND**

**CHINA AIRLINES FLIGHT CI611**

**BOEING 747-200, B-18255**

**MAY 25, 2002**

**AVIATION SAFETY COUNCIL**



**According to the Aviation Occurrence Investigation Act of the Republic of China, Article 5 :**

*The objective of the ASC 's investigation of aviation occurrence is to prevent recurrence of similar occurrences. It is not the purpose of such investigation to apportion blame or liability.*

**Further, according to the International Civil Aviation Organization (ICAO) Annex 13, Chapter 3, Section 3.1 :**

*The sole objective of the investigation of an accident or incident shall be the prevention of accidents and incidents. It is not the purpose of this activity to apportion blame or liability.*

**Thus, based on both the Aviation Occurrence Investigation Act of the Republic of China, as well as the ICAO Annex 13, this aviation occurrence investigation report shall not be used for any other purpose than to improve safety of the aviation community.**



# Executive Summary

On May 25 2002, 1529 Taipei local time (Coordinated Universal Time, UTC 0729), China Airlines (CAL) Flight CI611, a Boeing 747-200 (bearing ROC Registration Number B-18255), crashed into the Taiwan Strait approximately 23 nautical miles northeast of Makung, Penghu Islands of Taiwan, Republic of China (ROC). Radar data indicated that the aircraft experienced an in-flight breakup at an altitude of 34,900 feet, before reached its cruising altitude of 35,000 feet. The aircraft was on a scheduled passenger flight from Chiang Kai-Shek (CKS) International Airport, Taipei, Taiwan, ROC to Chek Lap Kok International Airport, Hong Kong, China. One hundred and seventy-five of the 225 occupants on board the CI611 flight, which included 206 passengers and 19 crewmembers, sustained fatal injuries; the remainders are missing and presumed killed.

According to Article 84 of the Civil Aviation Law, ROC at the time of the occurrence, and Annex 13 to the Convention on International Civil Aviation (Chicago Convention), which is administered by the International Civil Aviation Organization (ICAO)<sup>1</sup>, the Aviation Safety Council (ASC), an independent agency of the ROC government responsible for investigation of civil aviation accidents and serious incidents, immediately launched a team to conduct the investigation of this accident. The investigation team included members from the Civil Aeronautical Administration (CAA) of ROC, and CAL. Based on Annex 13 of

---

<sup>1</sup> The ROC is not an ICAO Contracting State but follows the technical standard of that organization.

ICAO, the National Transportation Safety Board (NTSB) of USA, the state of manufacture, was invited as the Accredited Representative (AR) of this investigation. Advisors to the US Accredited Representative were the US Federal Aviation Administration (FAA), the Boeing Commercial Airplane Company, and Pratt & Whitney.

After a year of factual data collection and three Technical Review Meetings, including wreckage recovery and examination, recorders' recovery and readout, and laboratory tests conducted at the Chung-Shan Institute of Science and Technology (CSIST), Boeing Materials Technology (BMT) Laboratory and Equipment Quality Analysis (EQA) Laboratory, the Safety Council published the factual data collection report (ASC-AFR-03-06-001) on June 3, 2003.

The analysis portion of the investigation process was commenced immediately after the release of the factual data collection report. A Preliminary Draft of the investigation report was sent to the CAA, CAL, and NTSB for their comments. A Technical Review Meeting (TRM4) was also held by the Safety Council to discuss the preliminary analyses prior to the release of the Preliminary Report. The intent of both TRM4 and the Preliminary draft were to solicit early feedback from the stakeholders. Based on the comments from CAA, CAL, and NTSB, a Final Draft was issued on May 21, 2004. The final report was approved by the 75<sup>th</sup> Council meeting on February 1, 2005 and published on February 25, 2005.

This report follows the format of ICAO Annex 13 with a few minor modifications. First, in Chapter 3, Conclusions, the Safety Council decided in their 39th Board meeting that in order to further emphasize that the purpose of the investigation report is to enhance aviation safety, and not to apportion blame or liability, the final report does not directly state the "Probable Causes and Contributing Factors", rather, it will present the findings in three categories: Findings related to the probable causes of the accident, findings related to risks, and other relevant findings. Second, in Chapter 4, in addition to the safety recommendations, the Safety Council also includes the safety actions already taken or planned by the stakeholders. This modification follows the practices by both the Australia Transport Safety Bureau (ATSB) and Transportation Safety Board (TSB) Canada, as well as follows the guidelines of Annex 13 of ICAO. The Safety Council decided that this modification would better serve its purpose for the improvement of aviation safety.

There are two volumes of the report. Volume I includes the investigation report and comments on the report from stakeholders. Volume II is the appendices. Although a considerable amount of factual information was collected during the investigation process, only the factual information relevant to the analysis is presented in the final report. It should also be noted that there is factual information in this report in addition to that contained in the factual data collection report published on June 3, 2003.

Therefore, based upon the analysis by the Safety Council, the following are the key findings of the CI611 accident investigation.

### **Findings as the result of this Investigation**

The Safety Council presents the findings derived from the factual information gathered during the investigation and the analysis of the CI611 accident. The findings are presented in three categories: **findings related to probable causes, findings related to risk, and other findings.**

**The findings related to the probable causes** identify elements that have been shown to have operated in the accident, or almost certainly to have operated in the accident. These findings are associated with unsafe acts, unsafe conditions, or safety deficiencies that are associated with safety significant events that played a major role in the circumstances leading to the accident.

**The findings related to risk** identify elements of risk that have the potential to degrade aviation safety. Some of the findings in this category identify unsafe acts, unsafe conditions, and safety deficiencies that made this accident more likely; however, they can not be clearly shown to have operated in the accident. They also identify risks that increase the possibility of property damage and personnel injury and death. Further, some of the findings in this category identify risks that are unrelated to the accident, but nonetheless were safety deficiencies that may warrant future safety actions.

**Other findings** identify elements that have the potential to enhance aviation safety, resolve an issue of controversy, or clarify an issue of unresolved ambiguity. Some of these findings are of general interest and are not necessarily analytical, but they are often included in ICAO format accident reports for informational, safety awareness, education, and improvement purposes.

## **Findings Related to Probable Causes**

1. Based on the recordings of CVR and FDR, radar data, the dado panel open-close positions, the wreckage distribution, and the wreckage examinations, the in-flight breakup of CI611, as it approached its cruising altitude, was highly likely due to the structural failure in the aft lower lobe section of the fuselage. (1.8, 1.11, 1.12, 2.1, 2.2, 2.6)
2. In February 7 1980, the accident aircraft suffered a tail strike occurrence in Hong Kong. The aircraft was ferried back to Taiwan on the same day un-pressurized and a temporary repair was conducted the day after. A permanent repair was conducted on May 23 through 26, 1980. (1.6, 2.3)
3. The permanent repair of the tail strike was not accomplished in accordance with the Boeing SRM, in that the area of damaged skin in Section 46 was not removed (trimmed) and the repair doubler did not extend sufficiently beyond the entire damaged area to restore the structural strength. (1.6, 1.16, 2.3)
4. Evidence of fatigue damage was found in the lower aft fuselage centered about STA 2100, between stringers S-48L and S-49L, under the repair doubler near its edge and outside the outer row of securing rivets. Multiple Site Damage (MSD), including a 15.1-inch through thickness main fatigue crack and some small fatigue cracks were confirmed. The 15.1-inch crack and most of the MSD cracks initiated from the scratching damage associated with the 1980 tail strike incident. (1.16, 2.2)
5. Residual strength analysis indicated that the main fatigue crack in combination with the Multiple Site Damage (MSD) were of sufficient magnitude and distribution to facilitate the local linking of the fatigue cracks so as to produce a continuous crack within a two-bay region (40 inches). Analysis further indicated that during the application of normal operational loads the residual strength of the fuselage would be compromised with a continuous crack of 58 inches or longer length. Although the ASC could not determine the length of cracking prior to the accident flight, the ASC believes that the extent of hoop-wise fretting marks found on the doubler, and the regularly spaced marks and deformed cladding found on the fracture surface suggest that a continuous crack of at least 71 inches in length, a crack length considered long enough to cause structural separation of the fuselage, was present before the in-flight breakup of the



aircraft. (2.2, 2.5)

6. Maintenance inspection of B-18255 did not detect the ineffective 1980 structural repair and the fatigue cracks that were developing under the repair doubler. However, the time that the fatigue cracks propagated through the skin thickness could not be determined. (1.6, 2.3, 2.4)

### **Findings Related to Risk**

1. The first Corrosion Prevention and Control Program (CPCP) inspection of the accident aircraft was in November 1993 making the second CPCP inspection of the lower lobe fuselage due in November 1997. CAL inspected that area 13 months later than the required four-year interval. In order to fit into the CAL maintenance schedule computer control system, CAL estimated the average flight time or flight cycles for each aircraft and scheduled the calendar year based inspection. Reduced aircraft utilization led to the dates of the flight hour inspections being postponed, thus the corresponding CPCP inspection dates were passed. CAL's oversight and surveillance programs did not detect the missed inspections. (1.6, 2.4)
2. According to maintenance records, starting from November 1997, B-18255 had a total of 29 CPCP inspection items that were not accomplished in accordance with the CAL AMP and the Boeing 747 Aging Airplane Corrosion Prevention & Control Program. The aircraft had been operated with unresolved safety deficiencies from November 1997 onward. (1.6, 2.4)
3. The CPCP scheduling deficiencies in the CAL maintenance inspection practices were not identified by the CAA audits. (1.6, 1.18, 2.4)
4. The determination of the implementation of the maximum flight cycles before the Repair Assessment Program was based primarily on fatigue testing of a production aircraft structure (skin, lap joints, etc.) and did not take into account of variation in the standards of repair, maintenance, workmanship and follow-up inspections that exist among air carriers. (1.6, 1.17, 1.18, 2.4)
5. Examination of photographs of the item 640 repair doubler on the accident aircraft, which was taken in November 2001 during CAL's structural patch survey for the Repair Assessment Program, revealed traces of staining on the aft lower lobe fuselage around STA 2100 were an indication of a possible hidden structural damage beneath the doubler. (1.6, 2.2)

6. CAL did not accurately record some of the early maintenance activities before the accident, and the maintenance records were either incomplete or not found. (1.6, 2.4)
7. The bilge area was not cleaned before the 1st structural inspection in the 1998 MPV. For safety purpose, the bilge area should be cleaned before inspection to ensure a closer examination of the area. (1.6,2.4)

### **Other Findings**

1. The flight crew and cabin crewmembers were properly certificated and qualified in accordance with applicable CAA regulations, and CAL company requirements. (1.5,2.1)
2. This accident bears no relationship with acts or equipment of the air traffic control services. (2.1)
3. This accident bears no relationship with the actions or operations by the flight crew or cabin crewmembers. (1.1, 1.5, 2.1)
4. The possibilities of a midair collision, engine failure or separation, cabin over pressurization, cargo door opening, adverse weather or natural phenomena, explosive device, fuel tank explosion, hazardous cargo or dangerous goods, were ruled out as potentials of this in-flight breakup accident. (1.10,1.11,1.12,1.13,1.16, 2.1)
5. There was no indication of penetration of fragments, residual chemicals, or burns that could be associated with a high-energy explosion or fire within the aircraft. (1.13, 1.14, 1.15, 2.1, 2.8)
6. The reasons for the unexpected position of some of the cockpit switches were undetermined. They might have been moved intentionally or may have been moved as the result of breakup, water impact, and wreckage recovery or transportation. (1.12, 1.16, 2.7)
7. Based on time correlation analysis of the Taipei Air Control Center air-ground communication recording and the CVR and FDR recordings, the CVR and FDR stopped recording simultaneously at 1527:59. (1.11, 2.6)
8. Except the very last sound spectrum, all other sounds from the CVR recording yielded no significant information related to this accident. (1.11, 2.6)

9. The sound signature analysis of the last 130 milliseconds CVR recording, as well as the power of both recorders been cut-off at the same time, revealed that the initial structural breakup of CI611 was in the pressurized area. (1.11, 2.6)
10. The last three Mode-C altitude data recorded by Xiamen radar between 1528:06 and 1528:14, most likely were inaccurate measurements because of the incorrect sensing of the static pressure tubes affected by severe aircraft maneuvering. (1.11, 2.9)
11. The ballistic analysis, although with assumptions, supports that the in-flight breakup of CI611 aircraft initiated from the lower lobe of the aft fuselage. Several conclusions can be drawn from the analysis: (1.11, 2.9)
  - Some segments might have broken away more than 4 seconds after power loss of the recorders. Several larger segments might have separated into smaller pieces after the initial breakup.
  - The engines most likely separated from the forward body at FL290 about 1528:33.
  - Airborne debris (papers and light materials) from the aft fuselage area, departed from the aircraft about 35,000 ft altitude, and then traveled more than 100 km to the central part of Taiwan.
12. If tracking radar data could be made available to both the salvage operation and accident investigations, the salvage operation could be accomplished in a timelier manner and the ballistic analysis would yield better accuracy. (1.12, 2.9)
13. There is no lighting standard for CAL during a structural inspections and the magnifying glass was not a standard tool for structural inspections. (1.6,2.4)
14. There was a problem in communication between Boeing Commercial Airplane Company and CAL regarding the tail strike repair in 1980. The Boeing Field Service Representative would have seen the scratches on the underside of the aircraft. However, the opportunity to provide expert advice on a critical repair appears to have been lost, as there are no records to show that the FSR had a role in providing advice on the permanent repair. (1.17, 2.3)
15. As demonstrated in the case of CI611, the accident aircraft had a serious hidden structural defect. High frequency eddy current inspection is not able

to detect cracks through a doubler. The crack would still not be detected if external high frequency eddy current had been used for structure inspection. Therefore, a more effective non-destructive structural inspection method should be developed to improve the capability of detection of hidden structural defects. (1.16, 2.4)

16. Due to the oriental culture and lack of legal authority to request autopsy, the autopsy was conducted only on the three flight crewmembers. (1.13, 2.8)

## **Recommendations**

### **To China Airlines**

1. Perform structural repairs according to the SRM or other regulatory agency approved methods, without deviation, and perform damage assessment in accordance with the approved regulations, procedures, and best practices. (1.6, 2.3,2.4)
2. Review the record keeping system to ensure that all maintenance activities have been properly recorded. (1.6, 2.4)
3. Assess and implement safety related airworthiness requirements, such as the RAP, at the earliest practicable time. (1.6, 2.4)
4. Review the self-audit inspection procedures to ensure that all the mandatory requirements for continuing airworthiness, such as CPCR, are completed in accordance with the approved maintenance documents. (1.6, 2.4)
5. Enhance maintenance crew's awareness with regard to the irregular shape of the aircraft structure, as well as any potential signs that may indicate hidden structural damage. (1.6, 2.2)
6. Re-assess the relationship with the manufacturer's field service representative to actively seek assistance and consultation from manufacturers' field service representatives, especially in maintenance and repair operations (1.6, 2.3)

### **To Civil Aeronautics Administration, ROC**

1. Ensure that all safety-related service documentation relevant to ROC-registered aircraft is received and assessed by the carriers for safety

of flight implications. The regulatory authority process should ensure that the carriers are effectively assessing the aspects of service documentation that affect the safety of flight. (1.6, 1.17, 2.4)

2. Consider reviewing its inspection procedure for maintenance records. This should be done with a view to ensuring that the carriers' systems are adequate and are operating effectively to make certain that the timeliness and completeness of the continuing airworthiness programs for their aircraft are being met. (1.6, 1.17, 2.4)
3. Ensure that the process for determining implementation threshold for mandatory continuing airworthiness information, such as RAP, includes safety aspects, operational factors, and the uncertainty factors in workmanship and inspection. The information of the analysis used to determine the threshold should be fully documented. (1.18, 2.2, 2.4)
4. Encourage operators to establish a mechanism to manage their maintenance record keeping system, in order to provide a clear view for inspector/auditors conducting records reviews. (1.6, 2.4)
5. Encourage operators to assess and implement safety related airworthiness requirements at the earliest practicable time. (1.6, 2.4)
6. Consider the implementation of independent power sources for flight recorders and dual combination recorders to improve the effectiveness in flight occurrence investigation. (1.11, 2.6)
7. Consider adding cabin pressure as one of the mandatory FDR parameter. (1.12, 2.7)
8. Closely monitor international technology development regarding more effective non-destructive inspection devices and procedure. (1.6, 2.2, 2.4)

### **To Boeing Commercial Airplane Company**

1. Re-assess the relationship of Boeing's field service representative with the operators such that a more proactive and problem solving consultation effort to the operators can be achieved, especially in the area of maintenance operations. (2.2, 2.3)
2. Develop or enhance research effort for more effective non-destructive inspection devices and procedures. (1.6,2.2,2.4)

**To the Federal Aviation Administration (FAA) of the U.S.**

1. Consider the implementation of independent power sources for flight recorders and dual combination recorders to improve the effectiveness in flight occurrence investigation. (1.11, 2.6)
2. Consider adding cabin pressure as one of the mandatory FDR parameter. (1.12, 2.7)
3. Ensure that the process for determining implementation threshold for mandatory continuing airworthiness information, such as RAP, includes safety aspects, operational factors, and the uncertainty factors in workmanship and inspection. The information of the analysis used to determine the threshold should be fully documented. (1.18, 2.2, 2.4)

**To Aviation Safety Council, Ministry of National Defense, and Ministry of Justice**

1. ASC should coordinate with the Ministry of Defense to sign a Memorandum of Agreement for the utilization of the defense tracking radar information when necessary, to improve efficiency and timeliness of the safety investigations. (1.11, 2.8)
2. ASC should coordinate with the Ministry of Justice to develop an autopsy guidelines and procedures in aviation accident investigation. (1.13, 2.8)

# Contents

Executive Summary .....	i
Contents.....	xi
Appendices .....	xxi
Tables .....	xxii
Figures.....	xxiii
Abbreviations .....	xxviii
1. Factual Information .....	1
1.1 History of Flight .....	1
1.2 Injuries to Persons .....	3
1.3 Damage to Aircraft .....	3
1.4 Other Damage.....	3
1.5 Personnel Information.....	3
1.5.1 The Captain (CM-1).....	3
1.5.2 The First Officer (CM-2).....	4
1.5.3 The Flight Engineer (CM-3).....	4

1.5.4	The Cabin Crew.....	4
1.6	Aircraft Information.....	5
1.6.1	General Information.....	5
1.6.1.1	Weight and Balance.....	6
1.6.1.2	Description of the B747-200 Fuselage Structure.....	6
1.6.1.3	Fuselage Skin Allowable Damage .....	8
1.6.2	Maintenance History of the Tail Strike at Hong Kong .....	10
1.6.2.1	Temporary Repair .....	11
1.6.2.2	Permanent Repair.....	12
1.6.3	CAL B747-200 Maintenance Program .....	12
1.6.3.1	B747-200 Maintenance and Inspection Periods.....	13
1.6.3.2	Structural Inspections .....	14
1.6.3.2.1	Structural Inspection Program.....	15
1.6.3.2.2	Corrosion Prevention and Control Program.....	16
1.6.4	B-18255 Maintenance Records.....	18
1.6.4.1	Airworthiness Directives and Service Bulletins .....	18
1.6.4.2	B-18255 Major Maintenance Check and Repair Records.....	18
1.6.4.3	B-18255 Structural Inspection Program Records.....	21
1.6.4.4	B-18255 CPCP Inspection Records .....	21
1.6.4.4.1	Delayed Inspections.....	25
1.6.4.5	Other Maintenance Records.....	28
1.6.5	Documentation Not Provided.....	29
1.6.5.1	Maintenance Record Keeping Regulations .....	29
1.6.6	Repair Assessment Program on B-18255 .....	30
1.6.7	Painting Tasks .....	34



1.6.8	Bilge Inspection - Before and After Cleaning.....	35
1.7	Meteorological Information.....	37
1.8	Aids to Navigation .....	38
1.8.1	Description of Primary and Secondary Radar.....	38
1.8.2	Radar Sites that Tracked CI611 .....	39
1.8.3	Time Synchronization .....	40
1.8.4	Secondary Surveillance Radar Data .....	40
1.8.5	Mode-C Altitude and FDR Recorded Altitude .....	43
1.8.6	Primary Surveillance Radar Data .....	43
1.9	Communications .....	45
1.10	Airport Information .....	45
1.11	Recorders.....	46
1.11.1	Cockpit Voice Recorder.....	46
1.11.2	Flight Data Recorder .....	47
1.11.3	Wind Profile Collected from FDRs of Other Aircraft .....	49
1.12	Wreckage and Impact Information.....	50
1.12.1	Introduction.....	50
1.12.2	Forward Body - Sections 41/42/44.....	51
1.12.3	Section 46.....	52
1.12.4	Empennage and Section 48 .....	56
1.12.5	Strut Structure and Engines.....	63
1.12.6	System Components .....	63
1.12.6.1	Flight Engineer's Instruments and Controls .....	64
1.12.6.2	Dado Vent Modules .....	66
1.13	Medical and Pathological Information.....	69

1.13.1	Victim Recovery, Examination and Identification.....	69
1.13.2	Toxicological Examination of Flight Crew .....	70
1.13.3	Victims' Injury Information.....	70
1.14	Fire .....	72
1.15	Survival Aspects.....	72
1.16	Tests and Research .....	72
1.16.1	Data Collection Flights.....	72
1.16.2	Tests of the System Components.....	72
1.16.3	Examination of Item 640.....	73
1.16.3.1	Examination of the Skin.....	74
1.16.3.2	Examination of the Repair Doubler.....	77
1.16.3.3	Examination of the Fracture Surfaces .....	81
1.17	Organizational and Management Information.....	85
1.17.1	CAL Engineering & Maintenance Division.....	85
1.17.1.1	History of Engineering & Maintenance Division .....	85
1.17.1.2	Structure of Engineering & Maintenance Division .....	87
1.17.1.3	Aircraft Maintenance.....	87
1.17.1.3.1	Base Maintenance Department .....	87
1.17.1.4	Shop Maintenance.....	88
1.17.1.4.1	System Engineering Department.....	88
1.17.1.4.2	Shop Maintenance Department .....	89
1.17.1.5	Quality Assurance Department.....	90
1.17.1.5.1	Inspection Procedure .....	91
1.17.1.6	CAL Maintenance and Inspection Procedures in 1980 .....	92
1.17.2	Boeing Field Service Representative .....	93

1.17.2.1	Communication Procedures .....	94
1.17.2.2	RAP Guidelines and Consultation .....	94
1.17.2.3	Boeing Field Service Representative in 1980.....	95
1.17.2.3.1	Boeing FSR Involved with the 1980 Tail Strike ....	96
1.17.3	The Civil Aeronautics Administration, ROC .....	97
1.17.3.1	CAA Evolution.....	97
1.17.3.2	CAA Organization .....	98
1.17.3.3	CAA Oversight .....	98
1.17.3.4	The Inspection System of CAA.....	98
1.17.3.5	Major Tasks of the Airworthiness Branch.....	99
1.17.3.6	CAA Inspection System from 1979 to Present .....	101
1.17.3.7	CAA International Connections.....	103
1.17.3.8	CAA Aging Aircraft Program .....	103
1.17.3.9	The Regulatory Oversight of CAL Maintenance.....	104
1.18	Additional Information .....	106
1.18.1	Wreckage Recovery .....	106
1.18.1.1	Introduction .....	106
1.18.1.2	Phase I Operation.....	107
1.18.1.3	Phase II Operation.....	107
1.18.1.4	Phase III Operation.....	108
1.18.1.5	Phase IV Operation .....	111
1.18.1.6	Wreckage Handling and Transportation .....	112
1.18.1.7	Wreckage Tagging.....	113
1.18.1.8	Wreckage Database .....	113
1.18.1.9	Summary .....	113

1.18.2	Security.....	116
1.18.3	Repair Assessment Program.....	116
1.18.3.1	Background.....	116
1.18.3.2	Issues Related to Older Repairs.....	117
1.18.3.3	Repair Assessment Process.....	118
1.18.3.4	Repair Assessment Threshold and Grace Period .....	119
1.18.3.5	Approved B747 Repair Assessment Guideline .....	119
1.18.3.6	Determination of the Assessment Threshold.....	121
1.18.3.7	China Airlines RAP .....	123
1.18.3.7.1	RAP for B-18255 .....	123
1.19	Wreckage Reconstruction.....	125
1.19.1	2D Hardware Reconstruction .....	125
1.19.2	3D Hardware Reconstruction .....	126
1.19.3	3D Software Reconstruction.....	128
2.	Analysis .....	133
2.1	General .....	134
2.1.1	Midair Collision .....	135
2.1.2	Engine Failure and Separation.....	135
2.1.3	Weather or Natural Phenomenon.....	135
2.1.4	Explosive Device .....	136
2.1.5	Fuel Tank Explosion .....	136
2.1.6	Cargo Door Opening .....	137
2.1.7	Cabin Overpressure .....	137
2.1.8	Hazardous Cargo and Dangerous Goods.....	137
2.1.9	Vertical Acceleration Data prior to the Breakup.....	138

2.2	Analysis of the Structural Failure .....	140
2.2.1	Power Loss of Flight Recorders .....	140
2.2.2	Dado Panels .....	142
2.2.3	CVR Signatures .....	143
2.2.4	Wreckage Distribution and Examination .....	144
2.2.5	RAP Preparation Data Collection during 6C Check .....	146
2.2.6	Examination and Structural Analysis of Item 640 .....	147
2.2.6.1	Origin and Pattern of the Fatigue Crack .....	148
2.2.6.2	The Existing Crack prior to the Breakup .....	149
2.2.7	Fracture Propagation .....	154
2.2.8	Summary .....	155
2.3	The 1980 Tail Strike Repair .....	157
2.3.1	The Occurrence in 1980 and its Subsequent Repairs .....	157
2.3.1.1	Wreckage Examination of the Repaired Area .....	157
2.3.1.2	Damage Assessment of the Structural Repair .....	158
2.3.2	The Manufacturer's Role .....	160
2.3.3	CAL Quality Control .....	161
2.3.4	The CAA's Role .....	162
2.4	Maintenance Issues .....	163
2.4.1	Structure Inspections .....	163
2.4.1.1	The Last Zonal Inspection in Aft Lower Lobe Area .....	164
2.4.1.1.1	Bilge Cleaning .....	165
2.4.1.1.2	Inspection Area Lighting Condition .....	165
2.4.1.1.3	Tools for the Zonal Inspection .....	166
2.4.2	Record Keeping .....	166

2.4.3	The RAP .....	167
2.4.3.1	The CAL RAP .....	167
2.4.3.2	The CAA RAP .....	168
2.4.4	CPCP Overdue Inspection Issues .....	170
2.4.4.1	CAL CPCP Inspection Time Control .....	170
2.4.4.2	Consequences of CPCP Overdue .....	172
2.4.4.3	Deficiencies in the CAL EMD.....	173
2.4.5	CAA Oversight of the CAL Maintenance Program .....	174
2.4.6	Continuing Airworthiness Challenges.....	175
2.5	Residual Strength Analysis .....	178
2.5.1	Operating Stress.....	179
2.5.2	Residual Strength for Crack Length up to 40 Inches.....	180
2.5.3	Influence of the Repair Doubler.....	182
2.5.4	Residual Strength of Cracking Length up to 90 Inches .....	184
2.5.5	Summary .....	185
2.6	CVR Related Analysis.....	186
2.6.1	CVR and FDR Stopped Time .....	186
2.6.2	Sound of Overpressure Relief Valve Opening.....	187
2.6.3	Unidentified Sounds .....	187
2.6.4	The Last Sound Signature.....	190
2.6.5	Summary .....	193
2.7	Pressurization and Pneumatic System Anomalies .....	194
2.7.1	Cabin Pressure Control Selector Panel.....	194
2.7.2	Air Conditioning Panel.....	195
2.7.3	Pressure Relief Valves .....	197

2.7.3.1	Upper Pressure Relief Valve.....	199
2.7.3.2	Lower Pressure Relief Valve.....	201
2.7.4	Summary .....	201
2.8	Injury Pattern.....	203
2.8.1	Explosives and Fire .....	203
2.8.2	Cabin Environment .....	203
2.8.3	Victims' Postmortem Examinations .....	203
2.9	Ballistic Analysis.....	205
2.9.1	Altitude Increase after Initial Breakup.....	205
2.9.2	Correction of PSR Return Signals.....	205
2.9.3	Ballistic Trajectory of the Wreckage Pieces .....	208
2.9.3.1	Introduction .....	208
2.9.3.2	Ballistic Trajectory Analysis for CI611 .....	209
2.9.3.3	Error Sources.....	211
2.9.3.4	Results .....	213
2.9.4	Higher Accuracy Tracking Radar .....	216
3.	Conclusions .....	219
3.1	Findings Related to Probable Causes .....	220
3.2	Findings Related to Risk .....	221
3.3	Other Findings.....	222
4.	Safety Recommendations.....	225
4.1	Recommendation .....	225
4.1.1	Interim Safety Bulletin (ASC-ISB-003-001) .....	225
4.1.2	Safety Recommendations .....	226
4.2	Safety Actions Taken or Being Planned .....	233

Attachment 1 - Comments on ASC's Final Draft Report from NTSB .....	243
Attachment 2 - Comments on ASC's Final Draft Report from CAL.....	251
Attachment 3 - Comments on ASC's Final Draft Report from CAA, ROC .....	267



# Appendices

Appendix 1	BASIC INFORMATION OF THE FLIGHT CREW
Appendix 2	BOEING 747-200 FUSELAGE STATION DIAGRAMS
Appendix 3	CAL ERE (747)- AS062
Appendix 4	BOEING FSR TELEX CI-TPE-80-22TE
Appendix 5	BOEING LETTER B-H200-17660-ASI
Appendix 6	CAL B-1866 ( B-18255 ) MAINTENANCE LOG BOOK OF YEAR 1980
Appendix 7	CAL B-1866 ( B-18255 ) 1980 REPAIR RECORD RELATED TO THE TAIL STRIKE
Appendix 8	WEATHER INFORMATION
Appendix 9	CI611 CVR TRANSCRIPT
Appendix 10	CI611 CVR SOUND SPECTRUM
Appendix 11	CI611 FDR PARAMETER LIST
Appendix 12	CI611 FDR PLOTS
Appendix 13	ASC CI611 WRECKAGE DATABASE
Appendix 14	SYSTEM COMPONENT TEST REPORT
Appendix 15	CSIST METALLURGICAL REPORT- ENGLISH VERSION
Appendix 16	BOEING BMT LAB REPORT
Appendix 17	ITEM 640 DOUBLER FAYING SURFACE EXAMINATION REPORT
Appendix 18	METHODOLOGY TO DETERMINE THE CRACK PROPAGATION
Appendix 19	RECOMMENDED ILLUMINATION LEVEL

# Tables

Table 1.2-1	Injury table .....	3
Table 1.6-1	Basic information about the accident aircraft .....	5
Table 1.6-2	Basic information about the engines .....	6
Table 1.6-3	Heavy maintenance schedule .....	18
Table 1.6-4	Major repair/alteration list .....	19
Table 1.6-5	Delayed and overdue CPCP inspection items for B-18255 .....	27
Table 1.12-1	Distribution of installed and recovered movable dado panels.....	68
Table 1.16-1	Maximum scratch depth measured in chosen locations .....	76
Table 1.16-2	Item 640C1 skin inboard surface corrosion details .....	77
Table 1.16-3	Length, depth of fatigue cracks on fracture above S-49L. ....	84
Table 1.18-1	Major pieces recovered from each area.....	111
Table 1.19-1	Data included for the development of 3D SWRPS.....	128
Table 2.6-1	Time events on ATC clock .....	186
Table 2.6-2	Unidentified sounds and possible events .....	189
Table 2.9-1	Summary of ballistic trajectories.....	213

# Figures

Figure 1.6-1	Description of the components on lower lobe frame .....	8
Figure 1.6-2	Fuselage skin allowable damage in SRM 53-30-01 .....	9
Figure 1.6-3	SRM 53-30-01 Figure 2 .....	10
Figure 1.6-4	The required inspection area of AMP CPCP item 53-125-01 .....	22
Figure 1.6-5	Locations of discrepancies adjacent to the STA 2060 doubler .....	24
Figure 1.6-6	Deviations on CPCP item 53-125-01 required for B-18255 .....	25
Figure 1.6-7	The doublers mapping .....	32
Figure 1.6-8	Aft of No.16 doubler (Picture taken on Nov 26,2001) .....	33
Figure 1.6-9	Fwd of No. 16 doubler (Picture taken on Nov 26,2001) .....	33
Figure 1.6-10	Various types of cavities along the doubler edge .....	34
Figure 1.6-11	Paint removed from the doubler edge with sealant remaining .....	35
Figure 1.6-12	A B747-200 aircraft bilge area with the CIC and dust removed .....	36
Figure 1.6-13	A B747-400 aircraft bilge area without removing CIC and dust .....	36
Figure 1.8-1	CI611 radar track, radar sites, and debris field .....	41
Figure 1.8-2	SSR returns from the Makung radar at 1529:15. ....	42
Figure 1.8-3	Makung PSR returns between 1528:03 and 1529:31 .....	42

Figure 1.8-4	CI611 Mode-C altitude returns, and the FDR recorded altitude .....	43
Figure 1.8-5	Time history of CI611 radar track and primary signal returns.....	44
Figure 1.8-6	CI611 radar track, PSR returns and wreckage position .....	45
Figure 1.11-1	Damaged CVR in the water cooler.....	46
Figure 1.11-2	Damaged FDR in the water cooler .....	47
Figure 1.11-3	Photographs of damaged magnetic tape .....	48
Figure 1.11-4	Sketch of damaged tape locations and conditions.....	48
Figure 1.12-1	Four distinct wreckage recovery zones .....	50
Figure 1.12-2	Majority portions of sections 41/42/44 found in yellow zone.....	52
Figure 1.12-3	Section 46 wreckage distribution.....	53
Figure 1.12-4	Item 723 (left) and item 741 (right) .....	53
Figure 1.12-5	Item 2019.....	54
Figure 1.12-6	Item 640.....	55
Figure 1.12-7	Item 640 and the repair doubler .....	55
Figure 1.12-8	Section 48 and empennage structure found in the red zone .....	56
Figure 1.12-9	Item 630.....	57
Figure 1.12-10	A small segment of fuselage stringer imbedded in the RHS elevator (left-down). A small fastener and shim were found inside the RHS leading edge (right)...	57
Figure 1.12-11	Vertical fin and item 22 .....	59
Figure 1.12-12	Item 630C1 .....	59
Figure 1.12-13	Doublers in section 48.....	60
Figure 1.12-14	The schematic diagram of the doublers in Section 48 .....	62
Figure 1.12-15	All engines were recovered in a relatively concentrated area.....	63
Figure 1.12-16	Cockpit section .....	64
Figure 1.12-17	Flight engineer panel .....	65
Figure 1.12-18	Dado vent modules.....	67

Figure 1.12-19	Typical dado vent modules in closed position .....	67
Figure 1.13-1	Cabin configuration and passenger seating assignment diagram .....	71
Figure 1.16-1	Exterior (up) and interior (down) of Item 640C1 .....	74
Figure 1.16-2	Faying surface with the repair doubler and protective finishes removed .....	75
Figure 1.16-3	A close view of the repair faying surface near STA 2080 .....	75
Figure 1.16-4	Locations chosen for scratch depth measurement .....	76
Figure 1.16-5	Skin corrosion features at STA 2100 .....	77
Figure 1.16-6	Light colored deposit on the faying surface of the repair .....	78
Figure 1.16-7	FT-IR analysis result.....	78
Figure 1.16-8	Fretting damage observed on faying surface of the repair doubler .....	79
Figure 1.16-9	Area of contact near hole 32 showing the different colors (left) and scratches present (right) .....	80
Figure 1.16-10	Metallographic photograph of the profiles marked by data sampling cut #1 in Figure 1.16-9 .....	80
Figure 1.16-11	Metallographic photograph of the profiles marked by data sampling cut #2 in Figure 1.16-9 .....	80
Figure 1.16-12	Distribution of the fatigue cracks (from STA 2060 to STA 2120) .....	82
Figure 1.16-13	Distribution of the fatigue cracks (from STA 2120 to STA 2180) .....	83
Figure 1.18-1	The Asia Pacific barge (left); the Coast Guard's dock (right) .....	108
Figure 1.18-2	The salvage vessel Jan Steen.....	109
Figure 1.18-3	Relative position of the two recorders and the wreckage.....	110
Figure 1.18-4	The wreckage distribution map .....	115
Figure 1.18-5	FAA approved Boeing 747 repair assessment guideline.....	120
Figure 1.19-1	Relative location of the recovered wreckage pieces .....	125
Figure 1.19-2	2D hardware reconstruction at TAFB Hanger #2 .....	126
Figure 1.19-3	3D hardware reconstruction (right side) .....	127

Figure 1.19-4	3D hardware reconstruction .....	127
Figure 1.19-5	Wreckage digitizing process (item 640) .....	129
Figure 1.19-6	Aligning of multiple datasets (item 640) .....	130
Figure 1.19-7	2D layout and 3D software reconstruction (left side).....	131
Figure 1.19-8	3D hardware and software reconstruction.....	131
Figure 2.1-1	CI611 vertical and lateral acceleration data (last 30 seconds).....	139
Figure 2.1-2	Vertical and lateral acceleration data comparison.....	139
Figure 2.2-1	Locations of flight recorders, transponder antennas, and power plants .....	142
Figure 2.2-2	Typical precursor and event sound signatures.....	143
Figure 2.2-3	Relative location of the wreckage.....	144
Figure 2.2-4	Wreckage distributions along the flight path.....	145
Figure 2.2-5	Comparison of Trace 1,2,3 (straight line) and 4 (curve).....	147
Figure 2.2-6	Fatigue crack originated from the scratch near hole 20 .....	148
Figure 2.2-7	Cracking on Item 640 differs from typical fatigue crack .....	149
Figure 2.2-8	The fretting marks caused by the pressurization cycles .....	150
Figure 2.2-9	The regular spacing of cracking increments found on Item 640 .....	151
Figure 2.2-10	SEM photographs of the cladding near hole 3 (left) and +15 (right) .....	152
Figure 2.2-11	SEM photographs of the cladding between hole 64 and 65.....	152
Figure 2.2-12	Different signs of cracks .....	153
Figure 2.2-13	Residual strength of cracking .....	154
Figure 2.2-14	Directions of fracture propagation .....	155
Figure 2.5-1	The linear finite element model of B747-200 aft fuselage.....	179
Figure 2.5-2	FEM refinement from STA 2040 to STA 2160 .....	180
Figure 2.5-3	The relation between the leading crack and MSD .....	181
Figure 2.5-4	The residual strength of the crack length up to 40 inches.....	181

Figure 2.5-5	The influence of the repair doubler.....	183
Figure 2.5-6	Residual strength of crack length up to 40 inches (with doubler) .....	183
Figure 2.5-7	The residual strength of the extents of the crack up to 90 inches.....	184
Figure 2.5-8	The combination of the two-stage residual strength analysis .....	185
Figure 2.6-1	Damaged and spliced tape areas.....	188
Figure 2.6-2	Comparison of the sound spectrum of three accidents .....	192
Figure 2.7-1	Cabin pressure control selector panel.....	194
Figure 2.7-2	Air conditioning panel .....	196
Figure 2.7-3	Pressure relief valves. ....	197
Figure 2.7-4	Break down of the pressure relief valve .....	198
Figure 2.7-5	Upper pressure relief valve .....	199
Figure 2.7-6	X-ray check results .....	200
Figure 2.7-7	Upper flapper doors pins measurement results .....	200
Figure 2.9-1	SSR track, PSR returns with altitude correction (red zone). ....	206
Figure 2.9-2	SSR track, PSR returns with altitude correction (yellow, green zones) .....	207
Figure 2.9-3	SSR track, PSR returns and position of major wreckages.....	208
Figure 2.9-4	Comparison of drifting distance on the wreckage of different ballistic coefficients.....	212
Figure 2.9-5	Two-Dimensional plot of ballistic trajectories.....	214
Figure 2.9-6	Three-Dimensional plot of ballistic trajectories.....	215
Figure 2.9-7	2D ballistic trajectories, SSR, PSR returns, and airborne debris .....	216

# Abbreviations

AACERC	Aircraft Accident Central Emergency Response Center
AATF	Airworthiness Assurance Task Force
AAWG	Airworthiness Assurance Working Group
AC	Advisory Circular
AD	Airworthiness Directives
AFB	Air Force Base
AMM	Aircraft Maintenance Manual
AMP	Aircraft Maintenance Program
AOM	Airplane Operations Manual
AOR	Aircraft Flight Operation Regulation
AP	Asia Pacific
A/P	Airframe/ Power-plant
APG	Airframe Power-plane General
APU	Auxiliary Power Unit
ARAC	Aviation Rulemaking Advisory Committee
ARSR	Air Route Surveillance Radars
ASC	Aviation Safety Council
ATA	Air Transport Association



ATC	Air Traffic Control
ATCAS	ATC Automation System
AUSS	American Underwater Search and Survey
BC	Ballistic Coefficient
BFSTPE	Boeing Field Service Representative at Taipei
BMT	Boeing Materials Technology
BOECOM	Boeing Communication
BL	Buttock Line
BS	Body Station
BZI	Baseline Zonal Inspection
CAA	Civil Aeronautics Administration
CAL	China Airlines
CAM	Cockpit Area Microphone
CAS	Commercial Aviation Service
CDR	Continuous Data Recording
CIC	Corrosion Inhibit Compound
CKS	Chiang Kai Shek International Airport
CPCP	Corrosion Prevention and Control Program
CSIST	Chung-Shan Institute of Science and Technology
CVR	Cockpit Voice Recorder
CVREA	CVR Explosive Analysis
DANTE	Data Analysis Numerical Toolbox and Editor
DP	Dynamic Positioning System
DSG	Design Service Goal
DV	Digital Video
EMD	Engineering and Maintenance Division
EO	Engineering Orders
EPD	Engineering Planning Department
EPR	Engine Pressure Radio
ERP	Enterprise Resources Planning

EQA	Equipment Quality Analysis
ERE	Engineering Recommendation
ERI	Electric Radio Instrument
ET	Eddy Current Inspection
ETOPS	Extended-Range Two-Engine Operations
E&M	Engineering & Maintenance
FAA	US Federal Aviation Administration
FARs	US Federal Aviation Regulations
FDR	Flight Data Recorder
FEM	Finite Element Model
FIR	Flight Information Region
FL	Flight Level
FPM	Feet Per Minute
FSRs	Field Service Representatives
FT-IR	Fourier- Transform Infrared Spectroscopy
GLB	Ground Log Book
GPS	Global Positioning System
IASA	International Aviation Safety Assessment
ICAO	International Civil Aviation Organization
IFSD	In Flight Shut Down
INS	Inertial Navigation System
JAA	Joint Aviation Authorities
JARs	Joint Aviation Regulations
LBL	Left Buttock Line
LHS	Left Horizontal Stabilizer
MAC	Mean Aerodynamic Chord
MB	Base Maintenance
MD	NDI of Shop Maintenance
ME	System Engineering Department
MED	Multiple Element Damage

MEL	Minimum Equipment List
ML	Line Maintenance
MI	Quality Management Office
MM5	The Fifth-Generation NCAR/Penn State Mesoscale Model
MMEL	Master Minimum Equipment List
MOC	Maintenance Operation Center
MOTC	Ministry of Transportation and Communications
MPD	Maintenance Planning Data
MPV	Mid Period Visit
MRS	Multi-Radar System
MRB	Maintenance Review Board
MSD	Multiple Site Damage
MSL	Mean Sea Level
MT	Magnetic Testing
MWF	Main Wreckage Field
NTAP	National Track Analysis Program
NCOR	National Center for Ocean Research
NDT	Non-Destructive Test
NDI	Non-Destructive Inspection
NM	Nautical Mile
NOTAM	Notice to Airmen
NPRM	Notice of Proposed Rulemaking
NTSB	US National Transportation Safety Board
OEM	Original Equipment Manufacturer
PMI	Principle Maintenance Inspector
PPS	Production Planning Section
PSR	Primary Surveillance Radar
PT	Liquid Penetration Inspection
QC	Quality Check
QNH	The barometric pressure as reported by a particular

RAG	Repair Assessment Guideline
RAP	Repair Assessment Program
RBL	Right Buttock Line
RCB	Reliability Control Board
RHS	Right Horizontal Stabilizer
RII	Required Inspection Item
RIPS	Recorder Independent Power Source
ROC	Republic of China
ROV	Remote Operating Vehicle
RT	Radiographic Testing
SARPs	Standards and Recommended Practices
SB	Service Bulletins
SEC	Section
SIP	Structure Inspection Program
SMS	Sheet Metal Skin
SOP	Standard Operation Procedure
SRM	Structure Repair Manual
SSI	Structural Significant Item
SSR	Secondary Surveillance Radar
STA	Station
STC	Supplemental Type Certificate
SWRPS	Software Wreckage Reconstruction and Presentation
TACC	Taipei Air Control Center
TAFB	Taoyuan Air Force Base
TAT	Total Air Temperature
TSB	Transportation Safety Board of Canada
TTM	Technical Training Manual
ULB	Underwater Locator Beacon
UT	Ultrasonic Testing
UTC	Coordinated Universal Time

VHF	Very High Frequency
VP	Vice President
WCS	Wing Center Section
WFD	Wide Spread Fatigue Damage

**Intentionally left blank**

# 1. Factual Information

## 1.1 History of Flight

On May 25, 2002, China Airlines (CAL) CI611, a Boeing 747-200, Republic of China (ROC) registration B-18255, was a regularly scheduled flight from Chiang Kai Shek International Airport (CKS), Taoyuan, Taiwan, ROC to Chek Lap Kok International Airport, Hong Kong. Flight CI611 was operating in accordance with ROC Civil Aviation Administration (CAA) regulations.

The captain (Crew Member-1, CM-1) reported for duty at 1305<sup>2</sup>, at the CAL CKS Airport Dispatch Office and was briefed by the duty dispatcher for about 20 minutes, including Notices to Airmen (NOTAM) regarding the TPE Flight Information Region (FIR). The first officer (Crew Member-2, CM-2) and flight engineer (Crew Member-3, CM-3) reported for duty at CAL Reporting Center, Taipei, and arrived at CKS Airport about 1330.

The aircraft was prepared for departure with two pilots, one flight engineer, 16 cabin crewmembers, and 206 passengers aboard. The crew of CI611 requested taxi clearance at 1457:06. At 1507:10, the flight was cleared for takeoff on Runway 06 at CKS. The takeoff and initial climb were normal. The flight contacted Taipei Approach at 1508:53, and at 1510:34, Taipei Approach

---

<sup>2</sup> All times contained in this report is Taipei local time (UTC plus 8), unless otherwise noted. All times have been correlated to the Makung radar time.

instructed CI611 to fly direct to CHALI<sup>3</sup>. At 1512:12, CM-3 contacted China Airlines Operations with the time off-blocks, time airborne, and estimated time of arrival at Chek Lap Kok airport. At 1516:24, the Taipei Area Control Center controller instructed CI611 to continue its climb to flight level 350, and to maintain that altitude while flying from CHALI direct to KADLO<sup>4</sup>. The acknowledgment of this transmission, at 1516:31, was the last radio transmission received from the aircraft.

Radar contact with CI611 was lost by Taipei Area Control at 1528:03. An immediate search and rescue operation was initiated. At 1800, floating wreckage was sighted on the sea in the area 23 nautical miles northeast of Makung, Penghu Islands.

---

<sup>3</sup> A fix in the JESSY ONE DEPARTURE (JE1) located at the Makung VOR/DME 038 radial, at 83 nautical miles.

<sup>4</sup> A waypoint on route A-1 located at the Makung VOR/DME 241 radial, at 72 nautical miles.



## 1.2 Injuries to Persons

All 206 passengers and 19 crewmembers aboard CI611 were fatally injured. The injury distribution is summarized in Table 1.2-1

Table 1.2-1 Injury table

Injuries	Flight Crew	Cabin Crew	Passengers	Others	Total
Fatal	3	16	206	0	225
Serious	0	0	0	0	0
Minor	0	0	0	0	0
None	0	0	0	0	0
Total	3	16	206	0	225

## 1.3 Damage to Aircraft

The aircraft was destroyed.

## 1.4 Other Damage

Not applicable.

## 1.5 Personnel Information

Appendix 1 contains a summary of basic information about the flight crewmembers.

### 1.5.1 The Captain (CM-1)

CM-1, a ROC Citizen, was born in 1951. He joined China Airlines on March 1, 1991, as a first officer. In March 1997 he was upgraded to captain. The medical certificate issued by the Aviation Medical Center reveals that CM-1 required corrective lenses while exercising the privileges of his airman certificate.

Based on interviews with the friends of CM-1, and the information retrieved from medical records, CM-1 was characterized as being in good health and did not take any medication or drugs. He had a good relationship with his family and was well respected by his colleagues. He was on stand-by and was called for the flight the morning of the accident. He had more than 24 hours off-duty before the accident. He was the pilot in command and occupied the left seat.

### **1.5.2 The First Officer (CM-2)**

CM-2, a ROC Citizen, was born in 1950. He joined China Airlines on February 1, 1990, as a first officer. The medical certificate issued by the Aviation Medical Center reveals that CM-2 required corrective lenses while exercising the privileges of his airman certificate.

Based on interviews with the family and friends of CM-2, and the information retrieved from medical records, CM-2 was characterized as being in good health and did not smoke or drink alcoholic beverages. He did not take any medication or drugs. He was on a scheduled day-off and was called for the flight about 0700 the morning of the accident. He had more than 24 hours off-duty before the accident. He was the pilot flying and occupied the right seat.

### **1.5.3 The Flight Engineer (CM-3)**

CM-3, a ROC Citizen, was born in 1948. He joined China Airlines on March 1, 1977, as a flight engineer. The medical certificate issued by the Aviation Medical Center reveals that CM-3 required corrective lenses while exercising the privileges of his airman certificate.

Based on interviews with the friends of CM-3, CM-3 liked to exercise, stopped smoking about 3 years ago and did not drink alcoholic beverages. He did not take any medication or drugs. He had more than 24 hours off-duty before the accident.

### **1.5.4 The Cabin Crew**

There were 16 cabin crewmembers on board the flight, one purser and 15 cabin crewmembers. All the cabin crewmembers received CAA approved initial and recurrent training programs from the In-flight Service Division of China Airlines.

## 1.6 Aircraft Information

### 1.6.1 General Information

The accident aircraft was acquired by China Airlines in July 1979 and was the second aircraft of the CAL B747-200 fleet. Basic information about the accident aircraft is shown in Table 1.6-1.

Table 1.6-1 Basic information about the accident aircraft

Item	Content
Aircraft Registration Number	B-18255 (Changed from B-1866 on May 18,1999)
Type of Aircraft	Boeing 747-200
Manufacturer	The Boeing Commercial Airplane Company
Manufacturer's Serial Number	21843
Delivery Date	August 2, 1979
Date Manufactured	July 15, 1979
Date Accepted by CAL	July 31, 1979
Operator	China Airlines
Owner	China Airlines
Configuration	22F/46C/288Y
Certificate of Airworthiness, Number/Validity Period	90-10-146/31 October 2002
Total Flight Hours	64,810
Total Cycles	21,398
Date of Last Stripping and Painting	Dec, 1993
Date of Last "D" Check	Dec 18, 1993
Date of Last Top-Coat Painting	Mar, 1996
Date of Last "MPV" Check	Jan 10, 1999
Date of Last "C" Check	Nov 25, 2001
Date of Last "B" Check	Apr 04, 2002
Date of Last "A" Check	May 03, 2002
Flight Hours/Cycles Elapsed Since Last Maintenance Check	76 Flight Hours/46 Cycles

Basic information about the four Pratt & Whitney JT9D-7A engines is shown in Table 1.6-2.

Table 1.6-2 Basic information about the engines

Engine Position	Serial Number	Install Date	Time since Installed	Total Hours	Total Cycles
1	695818	Nov 19, 2001	1222 hours	54014	13976
2	695746	Feb 28, 2002	412 hours	62258	15341
3	695829	Nov 21, 2001	1173 hours	54451	12486
4	695793	Dec 02, 2001	1122 hours	56333	14581

### 1.6.1.1 Weight and Balance

A CAL dispatcher at CKS prepared the load sheet for CI611. The dispatch release for CI611 showed a zero-fuel-weight of 444,487 pounds and takeoff weight of 509,287 pounds (within limits):

- Total Traffic Load            74,460 lbs.
- Dry Operating Weight        370,027 lbs.
- Takeoff Fuel                    64,800 lbs.

Based on the given locations and weight of the passengers, fuel, and cargo, the aircraft's takeoff center of gravity in mean aerodynamic chord (MAC) was calculated to be 25.6 percent (within limits).

### 1.6.1.2 Description of the B747-200 Fuselage Structure

In the B747-200 fuselage, applied loads are supported by both the skin and by internal structure including frames, stringers, shear ties, and stringer clips. The fuselage station diagrams that describe the frame numbering are shown in Appendix 2.

Key definitions related to the fuselage structure are described in the following:

#### Skin

The skin of the aircraft is constructed from sheets of aluminum alloy. The sheets are connected with lap joints and butt joints. Lap joints run longitudinally (along the length of the aircraft) and have one sheet overlapping the adjacent sheet.

Butt joints run circumferentially (around the cross-section of the fuselage) and are constructed with a splice plate to which is attached both adjoining skin sheets. The butt joint is so named because the skin sheets butt up against one another but do not overlap.

### **Stringers**

Stringers are longitudinal stiffeners attached directly to the skin that run the length of the fuselage and are located around the periphery of the cross-section.

### **Fuselage Frames**

Individual fuselage frames are located approximately every 20 inches along the length of the fuselage and conform to the cross-section of the aircraft. The frames themselves can be considered as beams with an upper and lower chord separated by a stiffened web. However, because the entire frame is approximately circular in shape, the chords are referred to as the inner chord and fail-safe (outer) chord. The inner chord essentially defines the interior cross-section of the cabin while the fail-safe chord of the frame is adjacent to the stringers. The fail-safe chords are so-named because they serve to help carry cabin pressurization loads (hoop tension) should a longitudinal crack develop in the skin. A drawing of the lower lobe portion of STA 2100 frame is shown in Figure 1.6-1.

### **Shear Ties**

Shear ties connect fuselage frames to the fuselage skin and are located between stringers. Shear ties serve to transfer loads between the frame and skin and to transfer hoop tension loads from the skin to the frame fail-safe chord should a crack develop in the skin.

### **Stringer Clips**

Stringer clips are located at frame/stringer intersections and serve to connect the frames to the stringers.

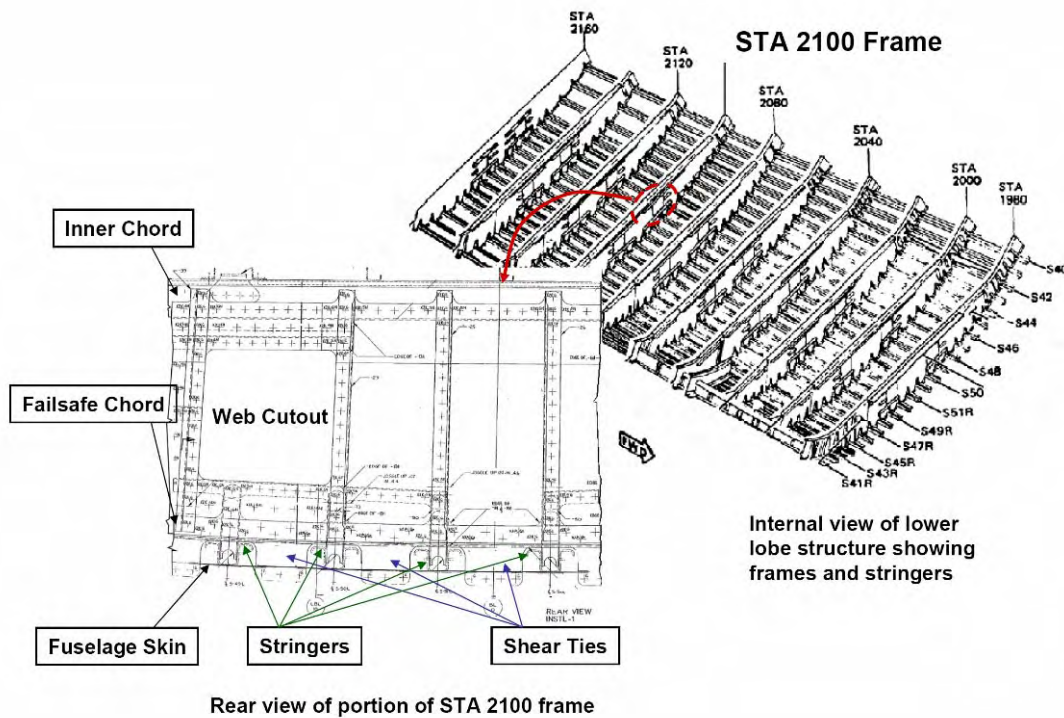

Figure 1.6-1 Description of the components on lower lobe frame

### 1.6.1.3 Fuselage Skin Allowable Damage

The Boeing 747 Structure Repair Manual (SRM) section 53-30-01, dated on June 15, 1976, provided the definition of fuselage skin allowable damage<sup>5</sup>; all areas other than the crown, the acceptable depth of clean up is limited to 20 percent of the original thickness. The distance of the damage from an existing hole, fasteners, or skin edge must not be less than 20 times of the depth of clean up. The fuselage skin allowable damage is shown in Figure 1.6-2.

<sup>5</sup> SRM 53-30-03 of September 15, 1977 stated: The damage includes cracks, nicks, gouges, scratches, corrosion, holes, and punctures, damage does not include dents.

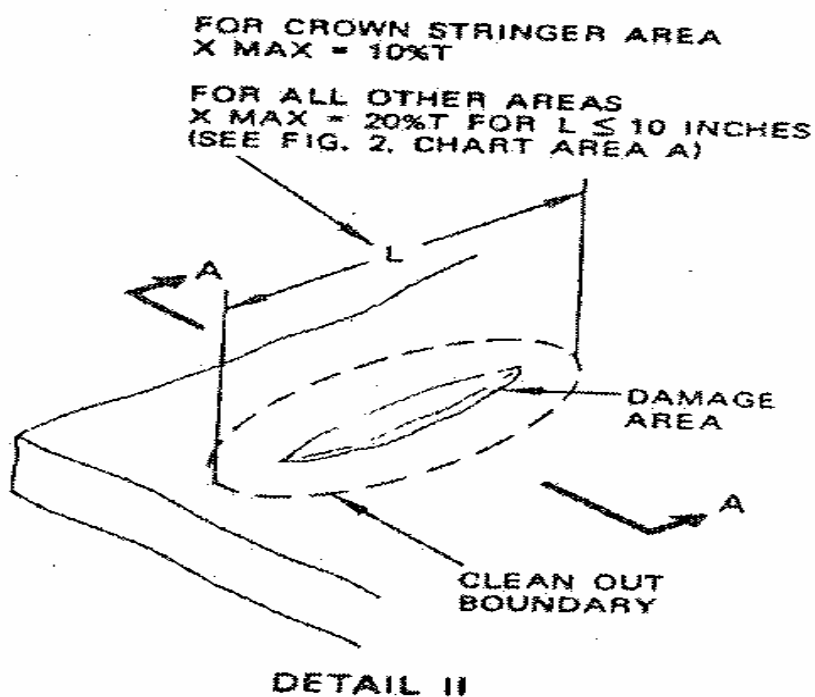
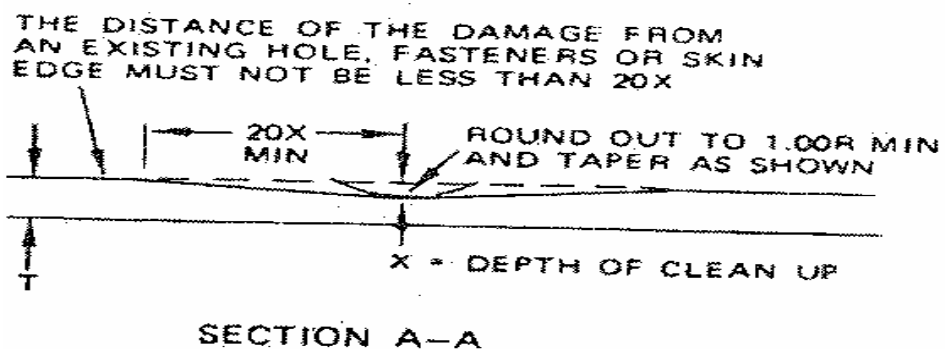

Figure 1.6-2 Fuselage skin allowable damage in SRM 53-30-01

SRM 53-30-01 Figure 2 also provided specific damage removal limits. If the damage length is less than about 10.2 inches, the depth of clean up is limited to 20 percent of the original thickness. If the damage length is longer than 11 inches, then the depth of clean up is limited to 15 percent of the original thickness (Figure 1.6-3).

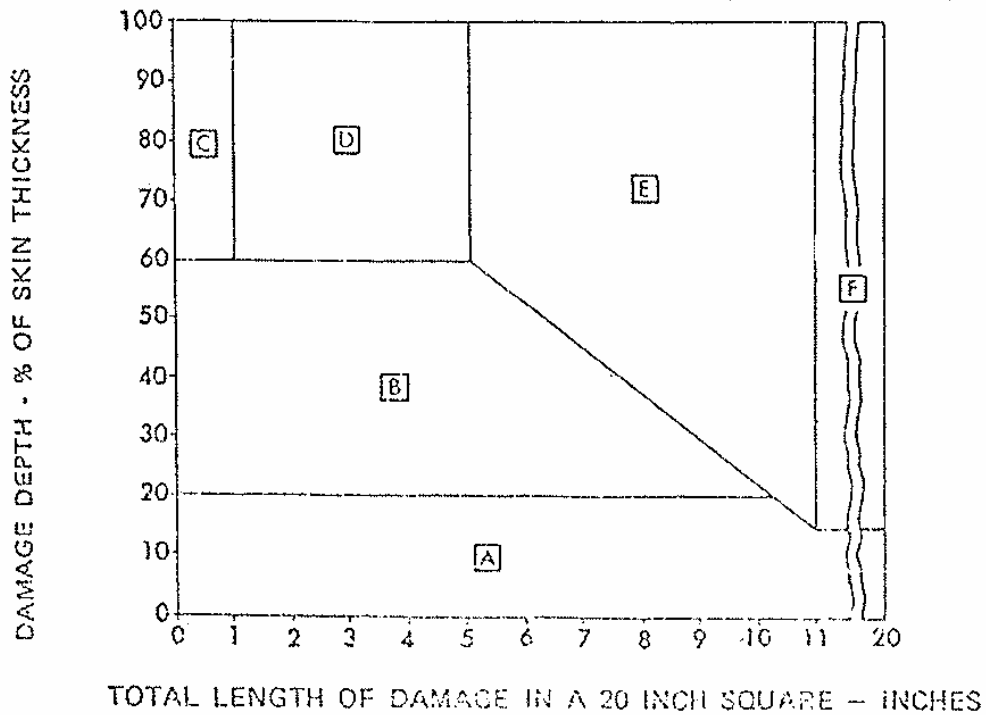

Figure 1.6-3 SRM 53-30-01 Figure 2

## 1.6.2 Maintenance History of the Tail Strike at Hong Kong

On February 7, 1980, the accident aircraft suffered tail strike damage during landing on the runway in Kai Tec Airport, Hong Kong. Preliminary inspection at Hong Kong after the tail strike found abrasion damage on aft fuselage portion bottom skin between STA 2080 and STA 2160, and between STA 2578 and 2658. The aft drain mast was missing and the left outflow valve door inboard corner was partially cut.

According to the CAL flight engineer's report, the aircraft was ferried back to CKS un-pressurized. There was no structural repair conducted at Kai-Tec Airport.

CAL was not able to provide the aircraft release information and a damage assessment or evaluation report of the specific damage that occurred in 1980 in Hong Kong.



### 1.6.2.1 Temporary Repair

A temporary repair was completed on February 08, 1980, per CAL Engineering Recommendation, ERE (747)-AS062, dated February 08, 1980 (Appendix 3). It stated:

- *Close visual inspection to internal structure for any defect inside the abraded skin.*
- *Install two reinforcing doublers, made of 0.063" 7075-T6 aluminum. Alloy plates at two places of the abraded area, forward 23 " by 125"<sup>6</sup> (to be sealed during installation on this pressurized area) and aft 15" by 54".*
- *Aft water drain mast reinstalled and functional test.*
- *Left outflow valve door cut area temporarily repair with 6061-T6 Aluminum alloy and functional test.*
- *Conduct permanent repair in accordance with B747 SRM within four months.*
- *The temporary repair was concurred by the local Boeing Representative on February 7, 1980.*

There were four signatures from the CAL Engineering Department and the Quality Control Department on this ERE (B747)-AS062.

With regard to the records of damage assessment, CAL stated:

*The description of damage contained in ERE (B747)-AS062 was considered adequate at the time, and the detailed description of the repair in the Boeing FSR TELEX CI-TPE-80-22TE indicated involvement of the FSR (field service representative) in determination of the extent of damage.*

The Boeing FSR TELEX CI-TPE-80-22TE is attached as in Appendix 4.

Regarding the temporary repair subsequent to the tail strike occurrence, a

---

<sup>6</sup> There is an inconsistency exists on the sketch that accompanies the ERE. For the Section 46 damage, the ERE depicts a temporary repair doubler 23" wide covering the area from S-49L to S-49R. In actuality, the distance from S-49L to S-49R is greater than 23". The doubler recovered on wreckage item 640 (section 1.16.3.1) measured 23" wide and covered only from S-49L to S-51R.

Boeing letter B-H200-17660-ASI in Mar 2003 stated (Appendix 5):

*BFSTPE (Boeing Field Service Representative at Taipei) advised Boeing that China Airlines had accomplished a temporary repair consisting of temporary skin patches made from .063 clad 2024-T3. BFSTPE further advised that China Airlines intended to complete a skin replacement or external patch permanent repair per SRM at a later date.*

### **1.6.2.2 Permanent Repair**

B-18255 Aircraft Logbook indicated that the aircraft was grounded for fuselage bottom repair from May 23 to 26, 1980 (Appendix 6). The “Major Repair and Overhaul Record” page of the same logbook recorded the permanent repair dated May 25, 1980 (Appendix 7), which stated that the repair was accomplished per the Boeing SRM section 53-30-03 figure 1.

The Safety Council was not able to obtain any other engineering process records regarding the permanent repair of this specific area, i.e. a complete description of the nature and location of the damage; drawings/diagrams depicting the size and shape of the repair; applicable engineering guidance and maintenance instructions; work cards containing complete description of the steps to remove and repair the damage and the inspector’s signoffs. CAL informed the Safety Council that the B-18255 tail strike structural repair in 1980 was not considered by CAL to be a major repair.

Regarding the permanent repair to the tail strike, Boeing stated that they “*have found no record that indicates Boeing was advised that the permanent repair had been completed.*”

### **1.6.3 CAL B747-200 Maintenance Program**

Based on a review of documents provided, CAL maintained B-18255 aircraft in accordance with the schedule of the CAA-approved B747-200 Aircraft Maintenance Program (AMP). The AMP work scope consisted of General Operation Specifications, Systems, Structure Inspection Program (SIP) and Corrosion Prevention and Control Program (CPCP). In order to maintain the safety condition of the aircraft, the components and appliances were maintained in accordance with specified time limits and cycles as stated in the AMP.

The China Airlines Boeing 747-200 AMP was developed from the Boeing 747 Maintenance Planning Data (MPD). This MPD listed Boeing recommended scheduled maintenance tasks including those listed in the FAA Maintenance Review Board (MRB) reports, plus additional economic tasks recommended by Boeing.

Damage tolerance<sup>7</sup> principles were incorporated into the AMP to ensure that structural damage would be detected in a timely manner. The program was designed to control environmental deterioration, including fatigue damage, corrosion, and accident damage.

For each task in the AMP, a corresponding Boeing maintenance task card was sent to China Airlines. The task cards were to be used by China Airlines to develop its own job cards. The job cards were then sent to line or base maintenance departments via the production control process.

### **1.6.3.1 B747-200 Maintenance and Inspection Periods**

In accordance with the CAL's AMP description, the Boeing 747-200 aircraft required the following periodic inspections for its safe operation.

#### Pre-flight Check

A pre-flight check should be accomplished prior to each flight of the day and when the aircraft was not in a transit condition.

#### Transit Check

The transit check is intended to assure continuous serviceability of an in- transit aircraft. This check is executed at an en-route stop.

#### Daily Check

Daily checks should be performed before the first flight of each calendar day, or once every 24 elapsed clock hours. It is intended for in-service aircraft.

---

<sup>7</sup> An evaluation of the strength, detail design, and fabrication must show that catastrophic failure due to fatigue, corrosion, manufacturing defects, or accidental damage, will be avoided throughout the operational life of the airplane.

### A Check

The “A” check is to be performed at a time in service not to exceed 350 flight hours.

### B Check

The “B” intermediate check is to be performed at a time not to exceed 125 days.

### C Check

The “C” periodic check is to be performed at a time not to exceed 12 months.

### D Check

The “D” check is to be performed at a time in service not to exceed 25,000 flight hours.

### Mid-Period Visit (MPV) Check

The MPV check is to be performed at a time between 12,500 flight hours and 14,000 flight hours, after a D check.

## **1.6.3.2 Structural Inspections**

In addition to AMP requirement, several inspection programs were designed to find the fatigue related damage for B747-200 aircraft. The Supplemental Structural Inspection (SSI) addresses the areas that were determined to require specific supplemental inspections for fatigue cracking. The Repair Assessment Program (RAP) provides inspection requirements for fuselage repairs. In addition, ADs and SBs are issued for areas with in-service findings and some of these directives/bulletins address fatigue related damage.

The SSI identifies Structure Significant Items have fatigue crack growth characteristics requiring inspection to assure timely detection of damage. Boeing Document D6-35022 provides the inspection methods, thresholds, and repeat intervals. The Revision G of document D6-35022 was approved by the FAA on February 22, 2002 and later was mandated by CAA AD 2002-06-011 on July 18, 2002. Subsequently FAA issued the same AD as FAA AD 2004-07-22 on March 24, 2004, which was effective on May 12, 2004. For all Model 747 series planes,

prior to reaching either of the thresholds specified in the AD, or within 12 months after the effective date of the AD, whichever occurs later, the operator must incorporate Boeing Document D6-35022 into an approved maintenance program. Prior to the FAA issuance of the AD 2004-07-22, CAL B747-200 fleet was not listed by the manufacturer as the candidate fleet for SSI.

A review of CAL records revealed that some AD and SB were related to structural inspection and B-18255 was in compliance with all applicable AD and required SB.

In addition, CAL Structure Inspection and Corrosion Prevention and Control Program records were reviewed to determine the procedures for compliances with the AMP.

#### **1.6.3.2.1 Structural Inspection Program**

The Structural Inspection Program (SIP) specifies the minimum acceptable programs to assure the continuing structural integrity of the aircraft. It listed 356 items; many of those items were applicable to only some variants of the B747-200 aircraft, for example freighter aircraft.

Other than specifies the minimum acceptable program to assure continuing structural integrity of a given aircraft, the SIP also outlines the structural sampling inspection requirements for CAL B747-200 aircraft fleet maintenance program. The sampling is where a percentage of CAL B747-200 fleet is inspected for a particular task.

According to Boeing 747 MPD dated November 1986:

*The preceding percentage corresponds to the portions of the operators' fleet that must be internally inspected for that particular period. Thereafter, an equal portion must be inspected at each subsequent interval until whole fleet has been inspected after which the cycle shall repeat. For example, 20% @25,000 hours signifies the ONE FIFTH of the operator's fleet must be inspected by 25,000 flight hours for that particular item. For a second interval of 20,000 one FIFTH by 45,000. For a third interval of 20,000 ONE FIFTH by 65,000 flight hours and so on until 100 percent of the fleet is inspected and the cycle will be repeated. However, after each*

*inspection is accomplished, future inspections are contingent upon the findings of the current inspection. The basic interval of 25,000 hours initial and 20,000 hours subsequent between sampling is approved only if no deterrent findings or defects are found. When a defect (including corrosion) is discovered during a sampling inspection, that item should revert to a 100% of the fleet inspection item and the interval between inspections should be reviewed/revaluated based on the operator's finding*

CAL B747-200 D check internal structural inspection included a CAA-approved 1/5 sampling program. That means that whole fuselage internal structural inspection were divided into 5 packages and implemented in turn at each subsequent D Check per MPD requirements.

#### **1.6.3.2.2 Corrosion Prevention and Control Program**

The objective of the Corrosion Prevention and Control Program (CPCP) is to prevent corrosion deterioration that may jeopardize continuing airworthiness of the aircraft<sup>8</sup>. To meet these requirements, the effectiveness of a CPCP is determined for a given aircraft area by the "level" of corrosion found on the principal structural elements during the scheduled inspections, and the need to conduct follow up repairs at an early stage. The CPCP listed 47 items in the AMP.

According to Boeing, Corrosion Prevention and Control Programs for each Boeing aircraft were developed under the direction of the International Airworthiness Assurance Working Group. This group developed a mandatory CPCP to establish minimum in-service maintenance procedures for aging aircrafts. Following these procedures is necessary to control corrosion and so ensure structural integrity and airworthiness for continued flight safety, regardless of aircraft age.

Airworthiness Directive (AD) 90-25-05 became effective on December 31, 1990 by the FAA, prompted implementation of the CPCP program. The CAA mandated an AD 79-747-146, notified all ROC operators to incorporate the

---

<sup>8</sup> The Boeing Company Aging Airplane Corrosion Prevention and Control Program, D6-36022 Rev. F, 2001.

CPCP into their AMP no later than December 31, 1991, and to implement the program as required. The CAL System Engineering Department incorporated the CPCP into their AMP and was approved by the CAA on September 9, 1991.

The CAA-approved AMP required 47 CPCP items to be inspected within certain time intervals. According to the CAL AMP and the Boeing 747 aging aircraft CPCP Document D6-36022 Rev. D, CPCP inspection intervals were controlled in calendar years<sup>9</sup>. In order to fit into the CAL maintenance schedule computer control system, CAL estimated the average flight time or flight cycles of each aircraft and scheduled the calendar year based inspection intervals into different letter checks. For instance, if the inspection items were in a 2-year interval, the CPCP inspection items would be merged into every other C checks; if the inspection items were in a 5, 6, or 8-year interval, they would be scheduled into the D checks. CPCP item 53-125-01 inspections were in a 4-year interval; they were scheduled for inspection in the PD (MPV) check.

In 1996, the CAL Maintenance Planning Section (MPS) of the System Engineering Department became aware that all scheduled CPCP inspection items in the letter checks might lead to late inspections. The MPS issued an internal memorandum to the Maintenance Operation Center (MOC) of the Line Maintenance Department, and asked the MOC to notify the MPS when the CPCP inspection intervals were approaching. The MPS proposed to amend the AMP to change all CPCP inspection intervals from letter checks to calendar-year intervals. The CAA approved the AMP amendment proposal.

According to data provided by CAL, there were no further communication between the System Engineering Department and MOC with respect to B747-200 CPCP scheduling issues, and no other department within CAL EMD monitored the implementation yield rate of the CPCP items. The MOC changed its C-check interval from 13 months to 12 months, but they did not change the CPCP schedule control. The CPCP inspection intervals remained the same as before the MPS internal memo.

---

<sup>9</sup> Because the accumulation of corrosion damage is time-dependant, CPCP inspection intervals are specified in calendar times.

## 1.6.4 B-18255 Maintenance Records

### 1.6.4.1 Airworthiness Directives and Service Bulletins

A review of CAL records revealed that B-18255 was in compliance with all applicable Airworthiness Directives (AD) and required Service Bulletins (SB).

### 1.6.4.2 B-18255 Major Maintenance Check and Repair Records

Scheduled heavy maintenance checks of B-18255 are listed in Table 1.6-3.

Table 1.6-3 Heavy maintenance schedule

CHECK	Begin Date	End Date	Flight Hour	Flight Cycle	Required Interval		Actual Interval	
MFG	1979/07/16							
1C	1980/8/11	1980/8/14	4132	947	395	DAY	392	DAY
2C	1981/8/8	1981/8/11	7604	1819	395	DAY	359	DAY
3C	1982/8/27	1982/8/30	10352	2635	395	DAY	381	DAY
4C	1983/9/5	1983/9/6	12268	3505	395	DAY	371	DAY
5C	1984/9/12	1984/9/16	14763	4319	395	DAY	372	DAY
6C	1985/9/24	1985/9/28	18472	5290	395	DAY	373	DAY
7C	1986/10/7	1986/10/12	21638	5962	395	DAY	374	DAY
8C	1987/9/24	1987/10/27	24054	6676	395	DAY	347	DAY
D	1987/9/24	1987/10/27	24054	6676	25000	F/H	24054	F/H
1C	1988/11/7	1988/11/14	26761	7497	395	DAY	377	DAY
2C	1989/11/17	1989/11/22	30907	8565	395	DAY	368	DAY
3C	1990/11/6	1990/11/7	34268	9803	395	DAY	349	DAY
MPV	1991/1/31	1991/3/1	34968	10065	14000	F/H	10914	F/H
4C	1991/10/31	1991/11/13	37260	10785	395	DAY	358	DAY
5C	1992/11/7	1992/11/24	41576	11853	395	DAY	360	DAY
6C	1993/10/9	1993/12/19	44818	12855	395	DAY	319	DAY
D	1993/10/7	1993/12/19	44818	12855	25000	F/H	20764	F/H
7C	1995/1/1	1995/1/18	48306	14038	395	DAY	378	DAY
8C	1996/1/30	1996/2/7	51536	15322	395	DAY	377	DAY
1C	1997/1/11	1997/1/19	53743	16321	365	DAY	339	DAY
2C	1998/1/15	1998/1/23	56378	17623	365	DAY	361	DAY
3C	1998/12/17	1999/1/11	57943	18241	365	DAY	328	DAY



CHECK	Begin Date	End Date	Flight Hour	Flight Cycle	Required Interval		Actual Interval	
MPV	1998/12/17	1999/1/11	57943	18241	14000	F/H	13125	F/H
4C	2000/1/10	2000/1/23	60088	19188	365	DAY	364	DAY
5C	2000/11/22	2001/1/4	61751	19954	365	DAY	304	DAY
6C	2001/10/28	2001/11/26	63638	20837	365	DAY	297	DAY

A list of major repairs/alterations of B-18255 provided by CAL is listed in Table 1.6-4.

Table 1.6-4 Major repair/alteration list

Date	ATA	Class	Subject	Documentation
1985/5/15	53/54	Major Repair	Repair and replacement -#3 NAC and RHS Horizontal stab damaged structure	FAA Form 337
1994/8/10	25	Major Alteration	Installation Of A Modular Lavatory Retrofit Kit In accordance with Heath Techno Drawing list No. Hpd-DI-44, rev. C dated May 2, 1994	STC SA5779NM
1994/9/8	34	Major Alteration	Wind shear Installation for B747-200	TIPSB747-984 R1
1995/7/31	23	Major Alteration	B747-200/SP Air show System Installation	TIPSB747-1004R2
1997/5/6	34	Major Alteration	Navigation - Independent Position Determine - Traffic Alert And Collision Avoidance System II (TCAS II) / ATC Mode S/VHF Antenna Structural Provision Installation	EO 742-34-45-0001
1997/6/16	34	Major Alteration	TCAS II Installation	TIPS B747-932R3
1998/12/30	57	Major Repair	RH Wing Lower Skin Corrosion WS 1548 Between STR 6 And 8 On B-1866	98-YUN-02
1999/1/6	53	Major Repair	B1866 LH STA1265 No.3 M.E.D. Body Frame Web Crack Repair	742-53-10-0001
2000/3/2	54	Major Repair	B-18255 #1strut Diagonal Brace Steel Fitting Fasteners Hole Crack Repair	742-54-00-2001
2000/3/22	57	Major Repair	B-18255 RH Wing Rear Spar Web Corrosion At WS 404 Repair	742-57-10-0015

Date	ATA	Class	Subject	Documentation
2000/3/24	57	Major Repair	RH Wing Front Spar Lower Chord Corrosion Common To FSSO 1465 (Time-Limited Repair)	742-57-10-0016
2000/5/31	57	Major Repair	RH Wing Front Spar Lower Chord Corrosion Common To FSSO 1465	742-57-10-0018
2000/12/11	57	Major Repair	B-18255 RH Wing Lower Skin T/E Corrosion Repair At WS 1466	742-57-50-0002
2000/12/11	53	Major Repair	B-18255 (rd081) STA 2598 Bulkhead Forward Inner Chord Crack Repair	742-53-10-0021
2000/12/12	34	Major Alteration	TCAS II Upgrade To TCAS Change 7	TIPS B747-1004 R2
2000/12/13	57	Major Repair	B-18255 LH Wing Front Spar Web Corrosion Repair At FSSO 1370 & 1390	742-57-20-0003
2000/12/16	57	Major Repair	B-18255 LH Wing Front Spar Web Corrosion Repair At FSSO 1047	742-57-20-0004
2000/12/18	53	Major Repair	B-18255 (rd081) LH Wing-To-Body Kick Fitting Outer Surface Corrosion Repair Common To Splice Strap At STA 1241	742-53-10-0022
2000/12/19	57	Major Repair	B-18255 (rd081) LH Wing Front Spar Web Corrosion Repair At FSSI 839	742-57-20-0005
2000/12/21	53	Major Repair	B-18255 (rd081) RH Wing-To-Body Kick Fitting Outer Surface Corrosion Repair Common To Splice Strap At STA 1241	742-53-10-0023
2001/8/28	28	Major Alteration	Butler National Corporation Transient Suppression Device Receive STC St00846se And Amoc AD 98-20-40 For Honeywell FQIS	742-28-40-0004R1
2001/11/12	54	Major Repair	#3 Strut Rear Engine Mount Bulkhead Web Crack Repair	742-54-10-0006
2001/11/13	57	Major Repair	B-18255 LH Wing Front Spar Web Corrosion Repair Between FSSI 570 And FSSI 591 And Between FSSI 610 And FSSI 628	742-57-10-0026

### **1.6.4.3 B-18255 Structural Inspection Program Records**

SIP package 5D5 was implemented to B-18255 in 1987. The internal structure skin, stringer, frames and shear ties between STA 1500 to STA 2160, S-40 to bottom centerline and STA 2160 to 2360, main deck floor line to bottom centerline were inspected. According to the records, no adverse finding around the aft bilge area.

SIP package 1D5 was implemented to B-18255 in 1993. According to the records, there was no adverse finding.

On December 24, 1998, the area between STA 1920 to 2160 and S-40L to S-40R was also inspected due to adverse findings found on other CAL B747-200 aircraft. There were no ground logbook entries.

### **1.6.4.4 B-18255 CPCP Inspection Records**

In accordance with the implementation threshold of the CPCP program, the first CPCP inspection of B-18255 was performed in a D check in November 1993. During the first implementation of CPCP, one CPCP level 2<sup>10</sup> discrepancy was found. It was located at the right wing spar chord and web. The defects were repaired in accordance with the CAL Engineering Instructions.

The second CPCP item 53-125-01 inspection took place on December 1998, as it was merged into the 3C/MPV check package. CPCP item 53-125-01 was intended to perform corrosion prevention of the interior of fuselage bilge between STA 460 to STA 1000, below stringer 40 L&R, and between STA 1480 to 2360, below S-42 L&R, including skin stringers, frames, bulkheads, longerons and cargo floor structure. Surveillance<sup>11</sup> inspection of the bilge is also intended to detect early stages of corrosion or indications of other discrepancies, such as

---

<sup>10</sup> Level 2 Corrosion is defined as corrosion occurring between successive inspections that it requires a single re-work/blend-out, which exceeds allowable limits, requiring a repair/reinforcement or complete or partial replacement of a PSE, as defined by the original equipment manufacturer's structural repair manual, or other structure listed in the Baseline Program.

<sup>11</sup> A visual examination of defined internal or external structural areas from a distance considered necessary to carry out an adequate check. Adequate lighting, inspection aids such as mirror etc., surface cleaning and access procedures may be required.

cracks or any structural damage. The required inspection area is shown in the red area in Figure 1.6-4.

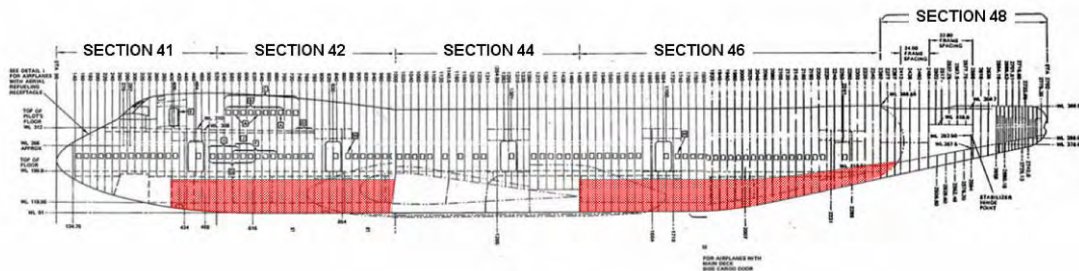

Figure 1.6-4 The required inspection area of AMP CPCP item 53-125-01

The job instruction card of inspecting fuselage after bilge interior states:

*05. Work instruction:*

- A. Visually inspect all PSE (primary structure element) and other listed structure from a distance considered necessary to detect early stages of corrosion or indications of other discrepancies such as cracking (e.g. surveillance inspection)*
- B. Pay particular attention to listed areas under the same task number. Where experience has shown corrosion may occur.*
- C. Additional non-destructive inspection or visual inspections following partial disassembly are required. If there are indications of hidden corrosion, such as bulging skins of corrosion running into splice, fitting, etc.*
- D. Remove all corrosion, evaluate damage and repair or replace all discrepant structure as required, including application of protective finishes.*

*10. Perform a detailed inspection per above work instruction in the following areas:*

- A. Interior of fuselage bilge, BS 1480 to BS 2360 bellow stringer 43 left and right, including skin, stringers, frames, bulkheads, longerons and cargo floor structure, with particular attention to the following:*

1. *Structure under galleys and lavatories.*
2. *Longitudinal skin lap splices*
3. *Bonded skin panel doublers, splices, cutout, etc.*
4. *Skin and doublers at outflow valves.*
5. *Aft and bulk cargo door cutouts.*
6. *Aft and bulk cargo door lower sill truss and latch fitting.*

During the CPCP aft bilge inspection, the inspector discovered 17 discrepancies adjacent to the doubler of item 640 as shown in the following (Figure 1.6-5).

1. Bulk cargo compartment lateral floor panel support beam corroded at STA 1920
2. Bulk cargo compartment floor panel support beams heavily corroded from STA 1920 to STA 2160
3. Bulk cargo compartment floor panel support beam cracked at STA 2120 & RBL-9
4. A "U" type support fitting cracked at STA 2080 and S-50L
5. Two "U" type support fitting cracked at STA 2060 & S-51L and S-51R
6. Bulk cargo compartment floor panel support beam cracked at STA 2060 & BL-0
7. Bulk cargo compartment floor panel support beam cracked at STA 2060 & RBL-9
8. Fuselage aft bilge S-43R corroded between STA 2000 & STA 2020.
9. Bulk cargo compartment floor panel support beam cracked at STA 2025 & BL-0
10. Fuselage aft bilge S-50L corroded between STA 1920 & 1960
11. Fuselage aft bilge S-49R corroded between STA 1940 & 1960
12. Fuselage inside skin corroded at STA 1920 between S-51L and S-48L
13. A doubler corroded at STA 1920 & LBL-10
14. Bulk cargo compartment floor panel support beam cracked at STA 2000 & LBL-50
15. Fuselage aft bilge S-46R corroded between STA 1860 & 1920
16. A web corroded at STA 1860 & 1880 and S-44R
17. Fuselage aft bilge S-51L, S51-R and S-50R corroded between STA 1840 & 1860

The above defects were corrected by the approved methods.

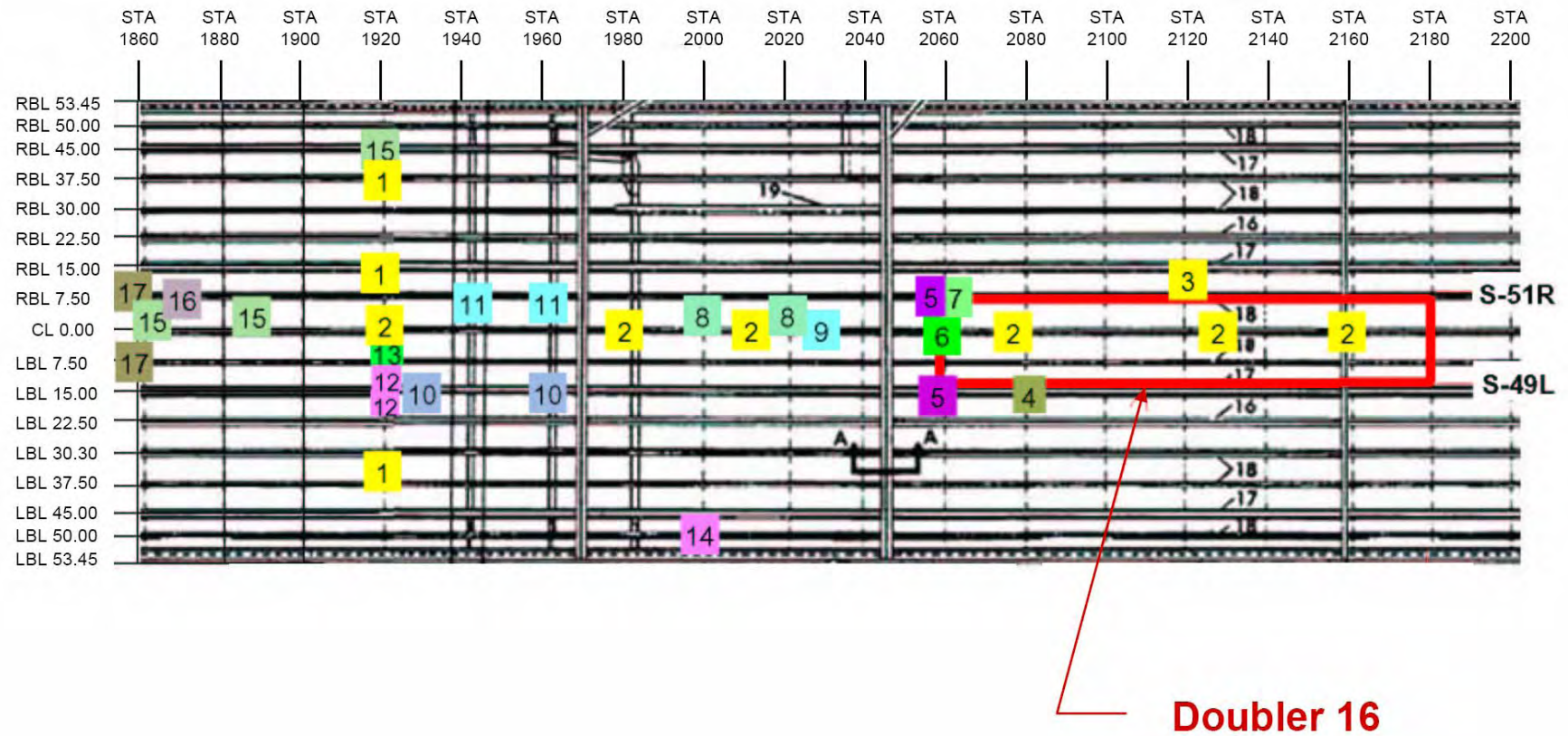

Figure 1.6-5 Locations of discrepancies adjacent to the STA 2060 doubler

### 1.6.4.4.1 Delayed Inspections

When the Safety Council reviewed the CAL B747-200 AMP with respect to B-18255's maintenance history, it was noted that AMP CPCP item 53-125-01 inspection of the bilge was delayed in implementation for 13 months until the 1998 MPV check. The AMP required this item to be inspected every 4 years.

Deviations between AMP CPCP item 53-125-01 required and actual implementation dates for B-18255 aircraft are shown in Figure 1.6-6.

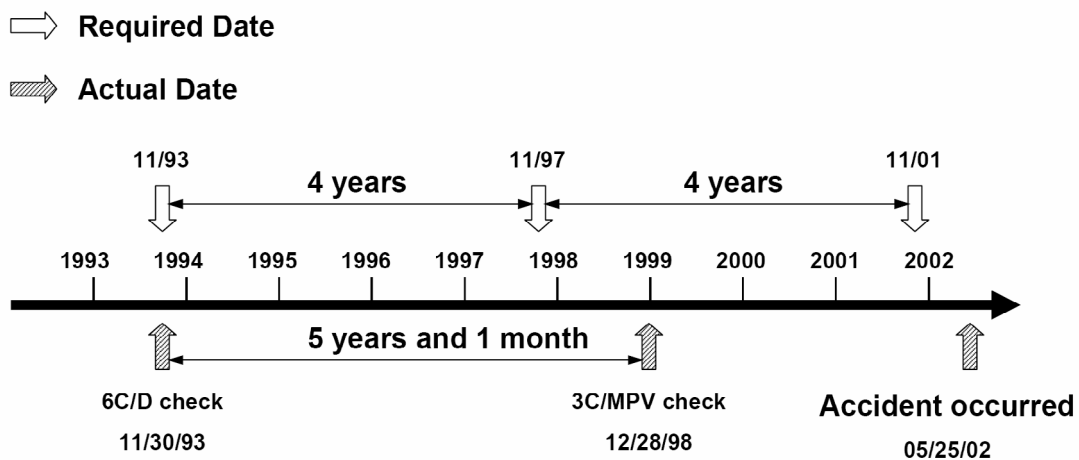

Figure 1.6-6 Deviations on CPCP item 53-125-01 required for B-18255

Other than CPCP item 53-125-01, another 28 items were found to have been deferred beyond the time intervals of the AMP required scheduled inspection dates. Neither CAL nor the CAA were aware of this CPCP schedule delay issue before November 5, 2003, the time when the Safety Council conducted investigation of this issue.

The items that were delayed in implementation and items that were overdue for inspection are as follows<sup>12</sup>, also see table 1.6-5.

1. 53-110-01 Fuselage Interior lower lobe above bilge, STA 134 to STA 460

<sup>12</sup> The words "delayed implementation" in this context refers to items that had gone past the required date for inspection; however, they were inspected at a later date. The word "overdue; refers to items that had gone past the required date for inspection and had not yet been inspected.

- S-26 L&R, STA 460 to STA 1000 above S-40 L&R, STA 1480 to STA 2160 above S-42 L&R, should be inspected at 6-year interval.
2. 53-125-01 Interior of fuselage bilge, STA 460 to STA1000 below stringer 40 L&R, and STA1480 to STA 2360 below S-42 L&R including skin stringers, frames, bulkheads, longerons and cargo floor structure, should be inspected at 4-year interval.
  3. 53-190-01 Fuselage and wing structure under wing-to-body fairings, air condition bay and keel beam, including fuselage skin, exterior surface of wing center section lower skin and portion of the front and rear spars and wing to body joints, should be inspected at 5-year interval.
  4. 53-200-01 Exterior surface of upper fuselage above S-34 L&R from STA 134 to STA 2360 and exterior surface of section 48, should be inspected at 5-year interval.
  5. 53-210-01 Interior of fuselage upper lobe from STA 134.75 to STA 2360 should be inspected at 8-year interval.
  6. 53-210-04 STA 1241 bulkhead splices strap and forging, should be inspected at 6-year interval.
  7. 53-210-05 Exterior surface of wing center section. Upper skin and longitudinal floor beams and seat tracks from STA 100 to STA 1265, should be inspected at 6-year interval.
  8. 53-210-06 longitudinal floor beams and seat tracks overpressure deck from STA 1265 to STA 1480 should be inspected at 6-year interval.
  9. 53-210-07 Main deck floor structure should be inspected at 6-year interval.
  10. 53-210-08 Cutout for entry doors, hatches, cargo doors and service doors should be inspected at 6-year interval.
  11. 53-210-09 Interior of main deck doors, hatches, cargo doors and service doors, should be inspected at 6-year interval.
  12. 53-210-10 STA 2360 AFT bulkhead lower chord should be inspected at 8-year interval.
  13. 53-221-01 Interior of flight compartment from STA 220 to STA 400 should be inspected at 8-year interval.
  14. 53-221-02 Crew compartment overhead hatch, should be inspected at 5-year interval.
  15. 53-310-01 SEC. 48 interior surface should be inspected at 5-year interval.
  16. 55-320-01 SEC. 48 exterior surface should be inspected at 5-year interval.
  17. 55-321-01 Interior of vertical stabilizer leading edge cavity forward of front spar, should be inspected at 8-year interval.
  18. 55-323-01 Interior of vertical stabilizer main box from front spar to rear spar



- should be inspected at 8-year interval.
19. 55-324-01 Interior of vertical stabilizer trailing edge cavity of aft of rear spar should be inspected at 5-year interval.
  20. 55-330-01 Exterior surface of horizontal stabilizer should be inspected at 5-year interval.
  21. 55-331-01 Interior of horizontal stabilizer leading edge cavity forward of front spar, should be inspected at 8-year interval.
  22. 55-333-01 Interior of horizontal stabilizer main box from front spar to rear spar should be inspected at 8-year interval.
  23. 55-334-01 Interior of horizontal stabilizer trailing edge cavity aft of rear spar should be inspected at 5-year interval.
  24. 55-338-01 Interior of horizontal stabilizer center section torsion box from front spar to rear spar should be inspected at 8-year interval.
  25. 57-131-02 Wing center section dry bays should be inspected at 5-year interval.
  26. 57-500-03 Wing lower skins at boost pump access, should be inspected at 5-year interval.
  27. 57-510-02 Interior of wing leading edge and areas above engine struts should be inspected at 6-year interval.
  28. 57-540-02 Wing dry bay areas should be inspected at 5-year interval.
  29. 57-540-03 Wing lower skin at fuel tanks access doors should be inspected at 5-year interval.

Table 1.6-5 Delayed and overdue CPCP inspection items for B-18255

Item	AMP NO.	Date of 1 <sup>st</sup> inspection	Due date	Date of 2 <sup>nd</sup> Inspection	Status
1	53-110-01	Nov 1993	Nov 1999	NO	Overdue
2	53-125-01	Nov 1993	Nov 1997	Dec 1998	Delayed
3	53-190-01	Nov 1993	Nov 1998	Jan 1999	Delayed
4	53-200-01	Nov 1993	Nov 1998	Jan 1999	Delayed
5	53-210-01	Nov 1993	Nov 2001	NO	Overdue
6	53-210-04	Nov 1993	Nov 1999	NO	Overdue
7	53-210-05	Nov 1993	Nov 1999	NO	Overdue
8	53-210-06	Nov 1993	Nov 1999	NO	Overdue
9	53-210-07	Nov 1993	Nov 1999	NO	Overdue
10	53-210-08	Nov 1993	Nov 1999	NO	Overdue
11	53-210-09	Nov 1993	Nov 1999	NO	Overdue

Item	AMP NO.	Date of 1 <sup>st</sup> inspection	Due date	Date of 2 <sup>nd</sup> Inspection	Status
12	53-210-10	Nov 1993	Nov 2001	NO	Overdue
13	53-221-01	Nov 1993	Nov 2001	NO	Overdue
14	53-221-02	Nov 1993	Nov 1998	Jan 1999	Delayed
15	53-310-01	Nov 1993	Nov 1998	Jan 1999	Delayed
16	55-320-01	Nov 1993	Nov 1998	Jan 1999	Delayed
17	55-321-01	Nov 1993	Nov 2001	NO	Overdue
18	55-323-01	Nov 1993	Nov 2001	NO	Overdue
19	55-324-01	Nov 1993	Nov 1998	Jan 1999	Delayed
20	55-330-01	Nov 1993	Nov 1998	Jan 1999	Delayed
21	55-331-01	Nov 1993	Nov 2001	NO	Overdue
22	55-333-01	Nov 1993	Nov 2001	NO	Overdue
23	55-334-01	Nov 1993	Nov 1998	Jan 1999	Delayed
24	55-338-01	Nov 1993	Nov 2001	NO	Overdue
25	57-131-02	Nov 1993	Nov 1998	Jan 1999	Delayed
26	57-500-03	Nov 1993	Nov 1998	Jan 1999	Delayed
27	57-510-02	Nov 1993	Nov 1999	NO	Overdue
28	57-540-02	Nov 1993	Nov 1998	Jan 1999	Delayed
29	57-540-03	Nov 1993	Nov 1998	Jan 1999	Delayed

#### 1.6.4.5 Other Maintenance Records

During the review of B-18255 3C/MPV check package, dated from December 17, 1998 to January 11, 1999, the Safety Council found:

1. Ten of the 42 non-routine job cards related to engine maintenance stated the parts were replaced with no record of a part number.
2. Thirteen of the 26 avionic systems non-routine cards stated the parts were replaced with no records of part number.
3. Four of the 49 sheet metal non-routine cards stated the parts were replaced with no records of part number.
4. On three discrepancy write-up cards, the mechanic reported many damaged items but did not specify the actual numbers of the damaged items.

## 1.6.5 Documentation Not Provided

During the investigation, the Safety Council requested all the maintenance documents related to the B-18255. Most of the documents were received, documents related to the 1980 tail strike were not available, except those two shown in Appendices 3 and 7. CAL stated that the locations for record keeping had been moved several times since 1980 and the records were either missing or could not be located.

When a request was made to Boeing to provide the AMM 05-51-36 of 1980 version, Boeing stated that they did not retain obsolete versions of the AMM.

### 1.6.5.1 Maintenance Record Keeping Regulations

According to the Aircraft Flight Operation Procedures of the Civil Aeronautics Administration in 1977:

#### Article 46

An operator shall ensure that the following records are kept:

The aircraft total time in service.

The aircraft main components' total time in service, overhaul and inspection report date.

The total time in service and the last inspection date of the aircraft instrument and equipment.

In addition to the regulations specify, all records shall be kept for a minimum period of 90 days after the unit to which they refer has been permanently withdrawn from service.

According to the Aircraft Certification Regulation of the Civil Aeronautics Administration in 1974:

#### Article 18

Aircraft, engine and propeller must have complete historic log books, and shall contain the following information:

1) Aircraft log book

(e) Accumulated flying hours and landing cycles.

(f) Special or major discrepancy and status of major component replacement or repair.

(h) Status of scheduled maintenance, overhauls, alterations and nonscheduled maintenance.

(i) Job performing records of all technical modification and status of time control component.

Article 19

2) Aircraft, aircraft engine or propeller historic logbook should be kept for 2 years after they are destroyed or withdrawn from service.

Article 21

The flight and maintenance log shall be kept for a minimum period of 6 months.

## **1.6.6 Repair Assessment Program on B-18255**

Boeing introduced RAP to CAL in May 2000. CAL followed the Boeing guidelines, D6-36181 revision D, to establish the company RAP on May 22 2001. The System Engineering Department of CAL issued an Engineering Order (EO) No.740-53-00-0003 to deal with pressurized skin inspections for specific repair conditions on May 24, 2001.

The CAA approved the program on May 28 2001. The RAP preparation for B-18255 was accomplished at the 6C check with the work to be commenced at the next 7C check (November 2002) before the aircraft accumulated 22,000 flight cycles. The repaired areas were to be inspected before the assessment threshold at or before 22,000 flight cycles.

B-18255 had accumulated 19,447 flight cycles and 60,665 flight hours by May 25, 2000, when the RAP was first introduced. The accident aircraft had accumulated 20,402 flight cycles and 62,654 flight hours by May 24, 2001, when the CAA approved the RAP for CAL. Aircraft B-18255 had accumulated a total of 21,398 flight cycles at the time of the accident.

CAL prepared a training program for RAP before it received approval from the CAA. CAL took photos of all the repair doublers in the pressurized area on the accident aircraft at the '6C' check on November 2, 2001. This was done in preparation for the commencement of the repair assessment program at the '7C' check scheduled for November 2, 2002 (before 22,000 flight cycles). CAL structure engineers completed the mapping and external inspection of all 31-repair doublers.

In addition to the mapping chart and photographs, CAL provided 22 maintenance records out of the 31 repairs related to the stage-1 efforts. CAL can not provide the other 9 maintenance records.

The B-18255 repair doubler mapping chart is shown in Figure 1.6-7. Photographs of number-16 doubler, the repair as the result of the 1980 tail strike, are shown in Figure 1.6-8 and 1.6-9. Number-16 doubler consists of two patches. The size of forward patch is 125 inches in length and 23 inches in width from STA 2060 to STA 2180. The aft patch is 60 inches in length and 23 inches in width from STA 2180 to STA 2240.

CHI B18255 (RDO81 .R1100, LN.386)

REPAIR DOUBLER MAPPING

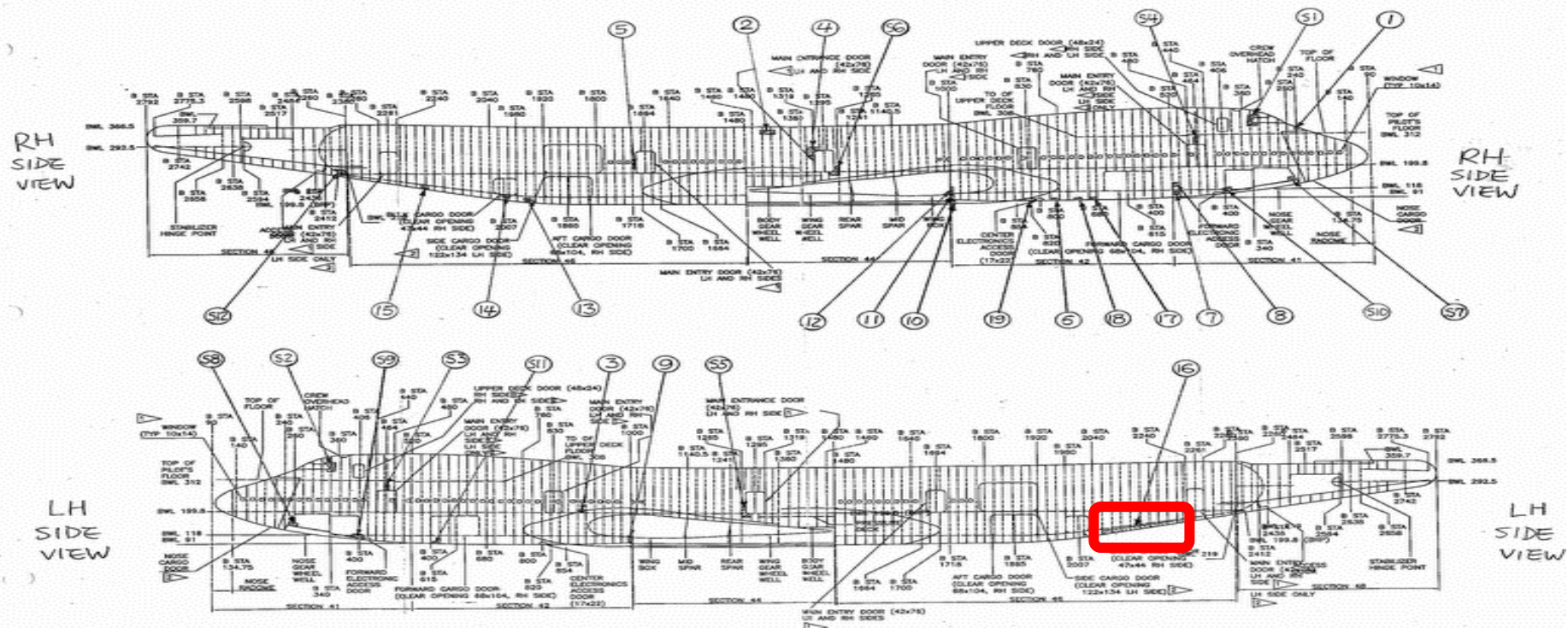

Figure 1.6-7 The doublers mapping

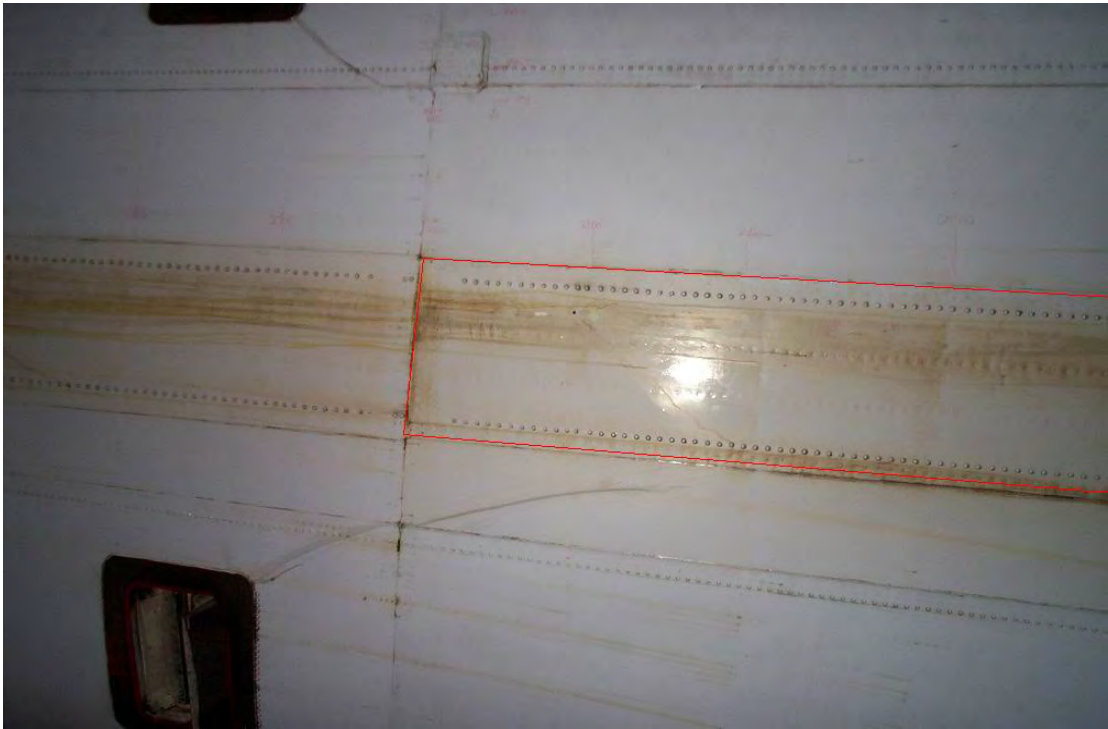

Figure 1.6-8 Aft of No.16 doubler (Picture taken on Nov 26,2001)



Figure 1.6-9 Fwd of No. 16 doubler (Picture taken on Nov 26,2001)

### 1.6.7 Painting Tasks

According to B-18255 aircraft maintenance record, the CAL paint shop performed the last repaint task in 1993 and the last topcoat painting in 1996. According to CAL repaint procedure, in 1993, the original paint was first removed, then sealant was replaced, then primer was applied, and finally topcoat was applied. Repaint procedure calls for the replacement of the sealant after old paint was removed to avoid contamination by stripper.

In 1996, the topcoat painting procedure would be sanding the painted shining surface, then primer was applied, then topcoat applied.

The exterior skin of number-16 doubler with various types of cavities around the rivets and along the edge of doubler can be observed as shown in Figure 1.6-10. Paint (topcoat) was present up to the edge of the doubler without sealant. In the same doubler paint (topcoat) was removed from the edge of the doubler during the doubler disassembly process, the sealant was still present, as shown in Figure 1.16-11.

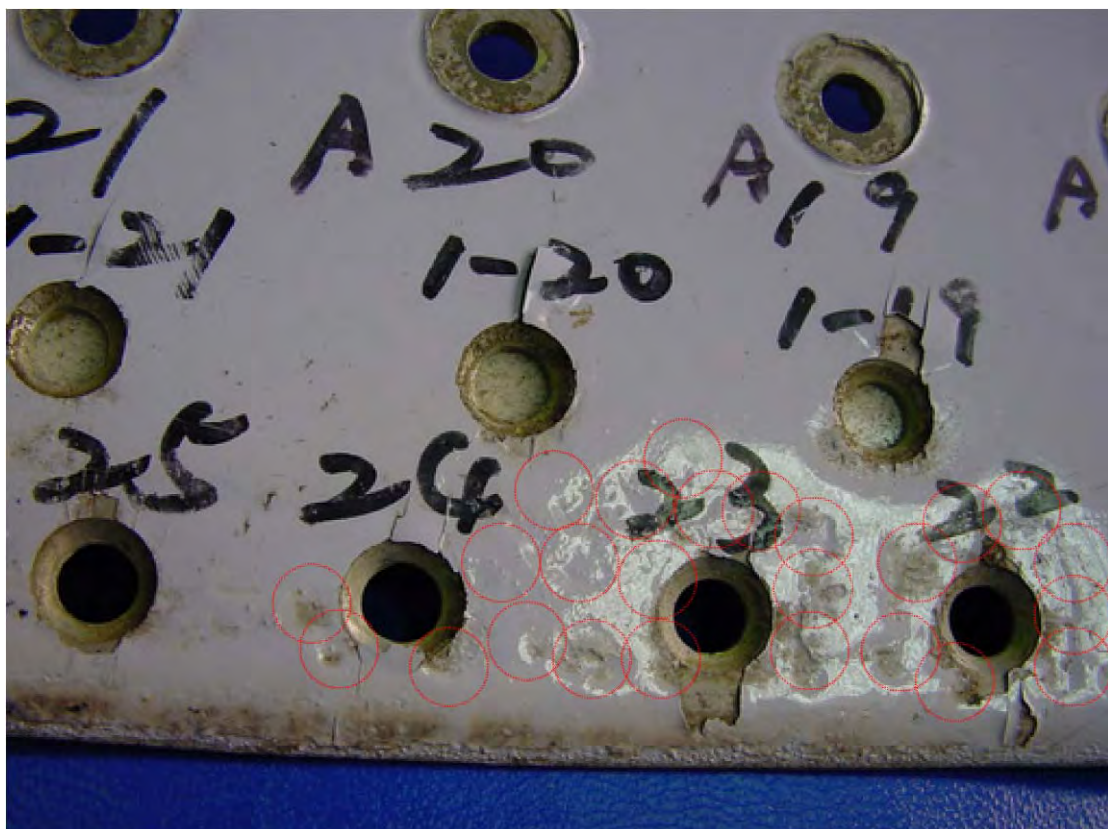

Figure 1.6-10 Various types of cavities along the doubler edge



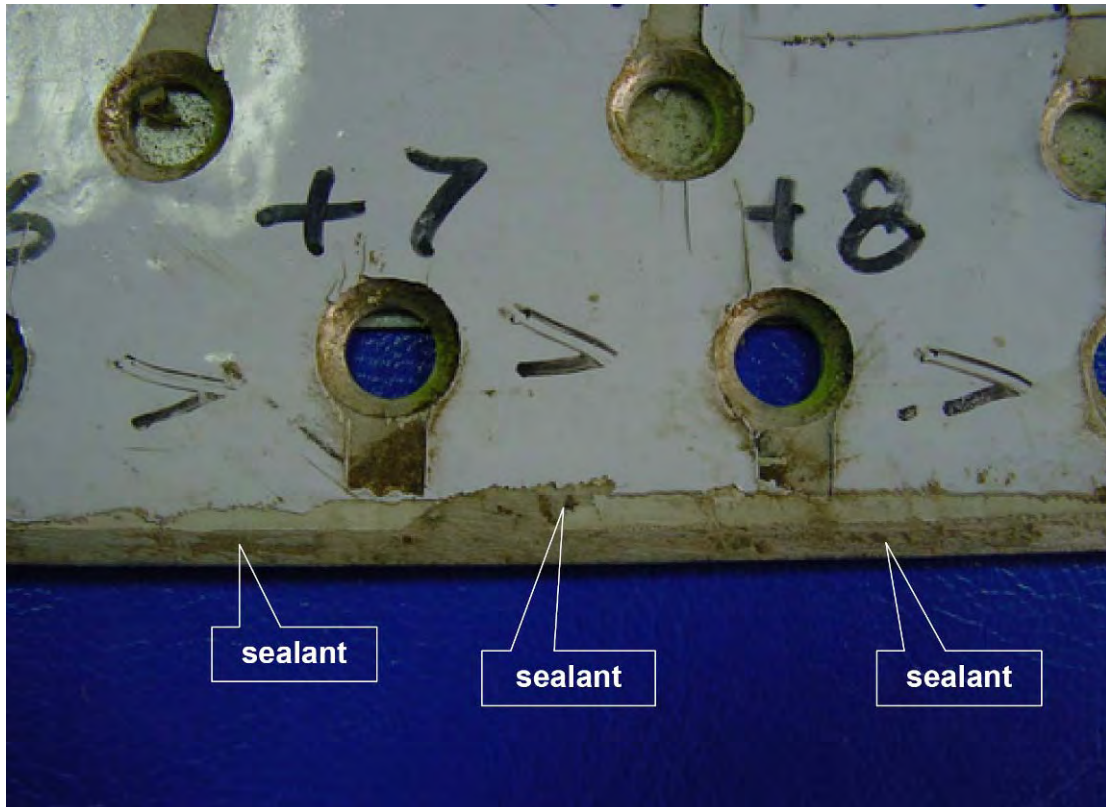

Figure 1.6-11 Paint removed from the doubler edge with sealant remaining

### 1.6.8 Bilge Inspection - Before and After Cleaning

The Safety Council conducted visual assessments during CAL's routine maintenance inspections on the interior fuselage bilge area with and without the corrosion inhibit compound (CIC) and dust. The assessments were conducted on a B747-200 freighter and a B747-400 freighter. Purpose of the assessment was to evaluate the visibility of the bilge area for the effectiveness of the inspection from STA 1920 to 2160 with and without the removal of the corrosion inhibit compound.

Figure 1.6-12 shows a B747-200 freighter bilge after cleaning. Figure 1.6-13 shows the bilge before corrosion inhibit compound and dust was removed from a B747-400 freighter. The stain on the lower lobe skin cover part of the paint. The bilge was covered with dirt and residue on two adjacent insulation blankets in the bulk cargo lower lobe bay.



Figure 1.6-12 A B747-200 aircraft bilge area with the CIC and dust removed



Figure 1.6-13 A B747-400 aircraft bilge area without removing CIC and dust

## 1.7 Meteorological Information

The following surface weather observations were made by the weather centers at CKS and Makung Airport:

### **CKS Airport**

1500: Type—record; Wind—070 degrees at 12 knots; Visibility—more than 10 kilometers; Clouds—few 4,000 feet, broken 8,000 feet; Temperature—28 degrees Celsius; Dew Point—15 degrees Celsius; Altimeter Setting (QNH)—1010 hPa (A29.84 inches Hg); Trend Forecast—no significant change.

### **Makung Airport (approximately 23 NM southwest of the accident site)**

1530: Type—record; Wind—020 degrees at 16 knots; Visibility—9 kilometers; Clouds—few 1,800 feet, broken 8,000 feet; Temperature—27 degrees Celsius; Dew Point—22 degrees Celsius; Altimeter Setting (QNH)—1009 hPa (29.81 inches Hg); Trend Forecast—no significant change.

The 0800 and 1400 surface weather charts indicated a cold front away from Taiwan and Taiwan was affected by northeast monsoon flow.

The 0800 analysis of the 300 hPa data (recorded about 30,000 feet Mean Sea Level-MSL) and 200 hPa data (recorded about 39,000 feet MSL) revealed a jet stream located in Japan. The winds in the central area of the Taiwan Strait were about 260 degrees at 25 knots and 260 degrees at 30 knots respectively.

The 1500 and 1600 Global Meteorological Satellite 5-GMS5 satellite images showed the top of the clouds were about 15,000 feet to 18,000 feet in the central area of the Taiwan Strait.

The 1530 Doppler weather radar data showed that there was no precipitation reflection around the site of the accident.

The 1530 Upper level wind and temperature data at the site of the accident calculated from the Fifth-Generation National Center of Atmospheric Research

-NCAR and Penn State Mesoscale Model (MM5)<sup>13</sup> is shown in Appendix 8.

## **1.8 Aids to Navigation**

There were no reported difficulties with navigational aids along the flight path of CI611.

### **1.8.1 Description of Primary and Secondary Radar**

Radar detects the position of an object by transmitting an electronic signal that is reflected by the object and returned to the radar antenna. These reflected signals are called “primary returns.” Knowing the speed of the radar signal and the time interval between when the signal was transmitted and when it was returned, the distance, called slant range, from the radar antenna to the reflecting object can be determined. Knowing the direction the radar antenna was pointing when the signal was transmitted, the direction (or azimuth) from the radar to the object can be determined. Slant range and azimuth from the radar to the object define the object’s position.

In general, primary returns can not measure the altitude of the sensed objects, but some military radar systems (height finders) have the capability to derive the altitude of an object. CAA radar system does not have the function to predict altitude.

The strength or quality of the returned signal from the object depends on several factors, including the range to the object, the object’s size and shape, and atmospheric conditions. In addition, any object in the path of the radar beam can potentially return a signal, and a reflected signal contains no information about the identity of the object that reflected it. The difficulties make distinguishing individual aircraft from each other and other objects (e.g., flocks of birds) based on primary returns alone unreliable and uncertain.

Currently, aircraft are equipped with transponder(s) that sense the beacon

---

<sup>13</sup>The Fifth-Generation NCAR / Penn State Mesoscale Model (MM5) is a limited-area, nonhydrostatic, terrain-following sigma-coordinate model designed to simulate or predict mesoscale atmospheric circulation.

interrogator signals transmitted from a secondary surveillance radar (SSR), and in turn the transponder transmits a response signal. Thus, even if a primary surveillance radar (PSR) is unable to detect a weak return, it may detect the transponder signal and is able to determine the aircraft position. The transponder signal contains additional information, such as SSR Code assigned for the aircraft and the aircraft's pressure altitude (also called Mode-C altitude). These transponder signals are called "secondary returns". The SSR Code assigned for CI611 was 2661.

## **1.8.2 Radar Sites that Tracked CI611**

There were five radars that detected the accident flight. These radars include: Chiang Kai Shek, Makung, Lehshan, Sungshan radar from Taiwan, and Xiamen radar from Mainland China.

In general, two types of air traffic control radar were used to provide position and track information, one for aircraft traversing at high altitudes between terminal areas, and the other for those operating at low altitude and speed within terminal areas.

Air Route Surveillance Radars (ARSR) are long range (250 NM) radars that track aircraft traversing between terminal areas. ARSR antenna rotates at 5 to 6 RPM, resulting in radar return every 10 to 12 seconds. A block of airspace may be covered by more than one ARSR antenna, in which case the data from these antennas are fed to a CAA central computer where the returns are sorted and the data converted to latitude, longitude, and altitude information.

The converted data are displayed at the Taipei Area Control Center (TACC) of the CAA, and recorded electronically in National Track Analysis Program (NTAP) text format. While an aircraft may be detected by several ARSRs, the radar controller will only see one radar return on his display for that aircraft, and only one set of position data will be recorded in NTAP format for that aircraft. The raw data generated by each ARSR is not recorded in the NTAP file; rather, the position information computed by sorting through the returns from all the ARSRs sending data is recorded.

The CAA Airport Surveillance Radars (ASRs) are short or middle range (60-140 NM) radars used to provide air traffic control services in terminal areas. CAA records the data received by each site in Continuous Data Recording (CDR) text

format.

In addition, Xiamen radar in Mainland China only recorded the SSR data of CI611. Xiamen radar system can be recorded and played back only in video format.

### **1.8.3 Time Synchronization**

To calculate performance parameters from the radar data (such as ground speed, track angle, rate of climb, etc.), a post-processing program, DANTE<sup>14</sup> was used. All CI611 radar data were synchronized to the UTC radar time of Makung, which is based on the TACC time system. TACC radar time is calibrated in accordance with the Chunghwa Telecom Co., Ltd. time system.

### **1.8.4 Secondary Surveillance Radar Data**

There are two radar recording/playback systems at TACC, one is the ATC Automation System (ATCAS), which only records the SSR returns. Another is the Micro-ARTS, which playback both PSR and SSR returns from military radars at Lehshan and Sungshan. Figure 1.8-1 shows the radar track of CI611 and debris spread (radar track: red line; debris spread: green circle), the five radar sites tracked the CI611 flight are also marked in Figure 1.8-1.

The video recording system uses the digital video recorder (DV) to capture radar playbacks from TACC, and post-processed the DV to specific frames. According to TACC radar recording, the last SSR return of CI611 received from Makung radar was at 1528:03, the altitude was 34,900 ft. After the CI611 SSR return disappeared, a "CST" (coast) status appeared on radar screen at 1529:15 (Figure 1.8-2). After that time, the PSR returns were continuously recorded by Makung radar.

Figure 1.8-3 shows the primary returns of the Makung radar between 1528:03 and 1529:31. There are two waypoints on every clip images, SWORD and

---

<sup>14</sup> DANTE (Data Analysis Numerical Toolbox & Editor) is a pc-based program developing by NTSB, it provides a variety of routines for manipulating, analyzing flight data. In addition, DANTE contains specialized routines that simplify or automate many of the Digital Flight Data Recorder (DFDR) and Radar data processing tasks required for analyzing aircraft performance.

KADLO. Other black points on Figure 1.8-3 are primary returns of CI611.

After Makung Radar site received the last SSR returns, there were three more signals received by Xiamen SSR. Those are listed in the following<sup>15</sup>:

- 1528:04 34,613ft
- 1528:09 34,777ft
- 1528:14 34,843ft

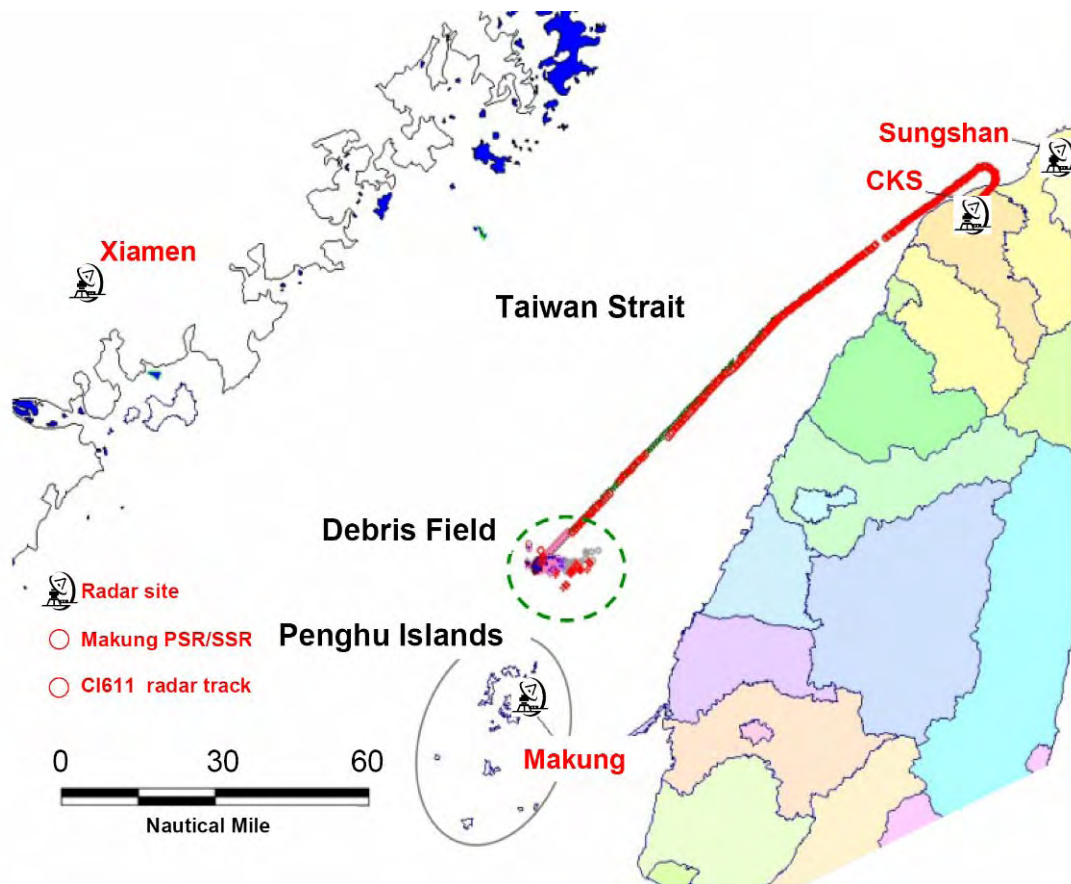

Figure 1.8-1 CI611 radar track, radar sites, and debris field

---

<sup>15</sup> After time synchronization with the Makung Radar Timing System

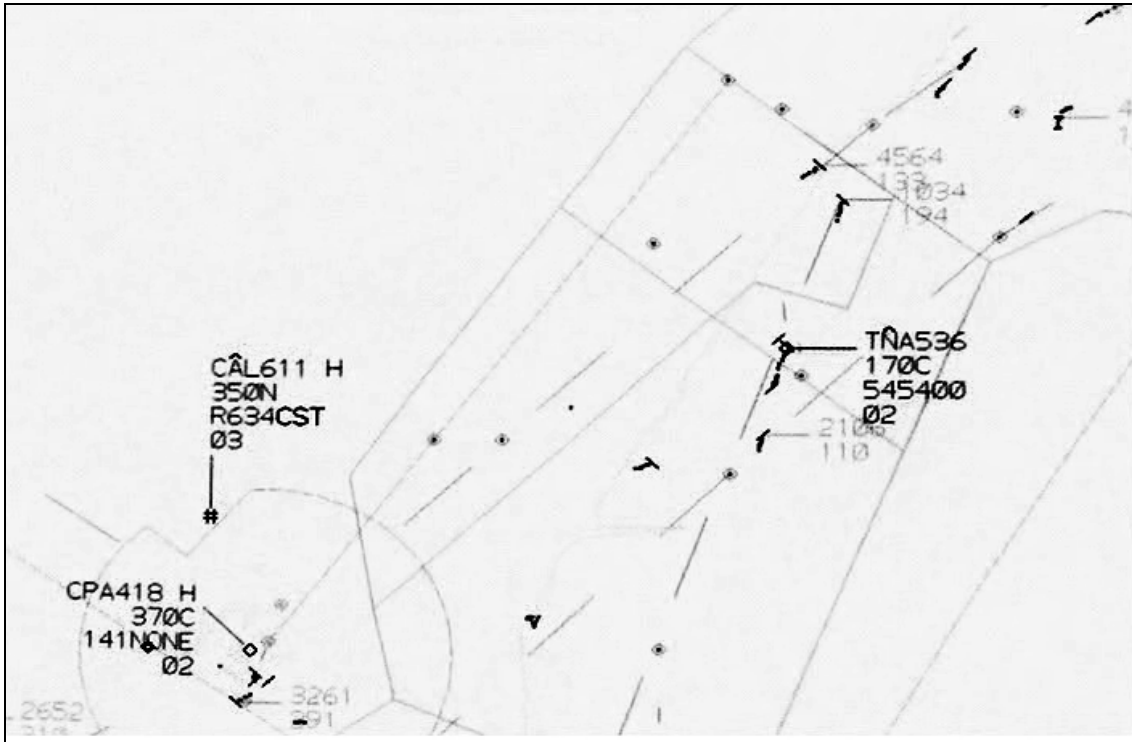

Figure 1.8-2 SSR returns from the Makung radar at 1529:15.

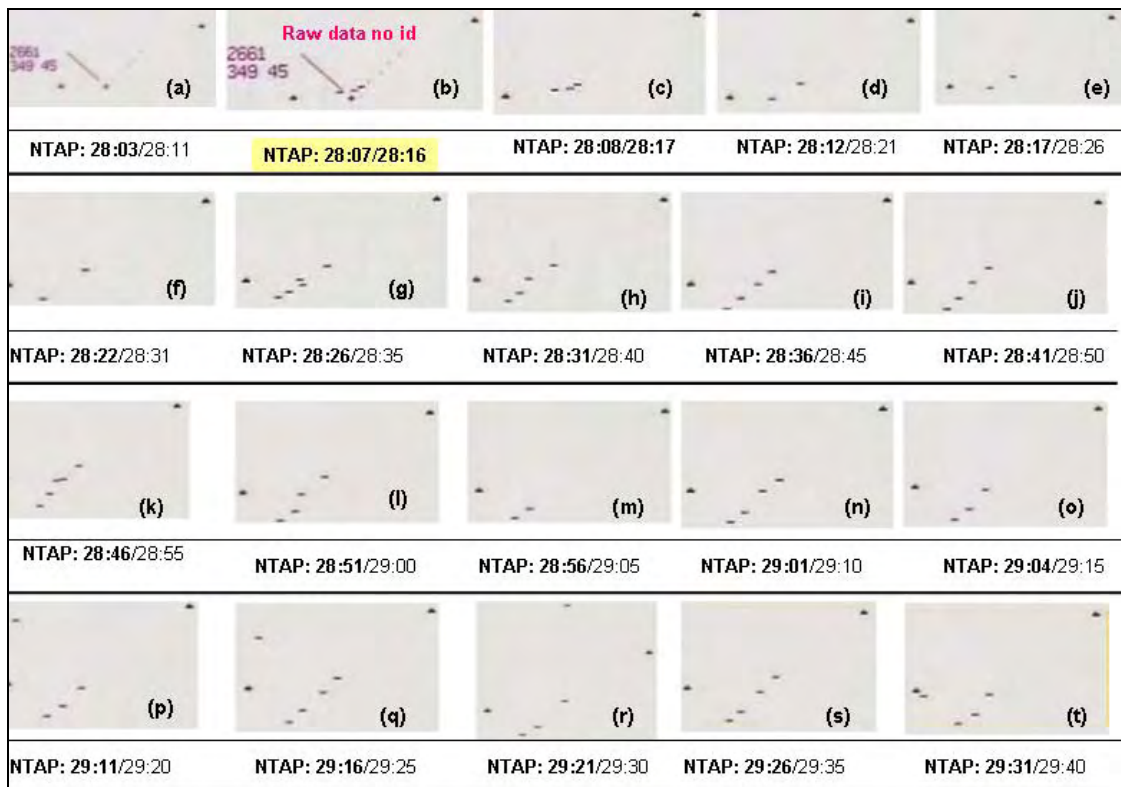

Figure 1.8-3 Makung PSR returns between 1528:03 and 1529:31



### 1.8.5 Mode-C Altitude and FDR Recorded Altitude

Figure 1.8-4 shows the CI611 Mode-C altitude readout, and the FDR recorded altitude in UTC time (FL330 to last SSR signal). The FDR of the CI611 flight stopped recording at 1527:59. The last SSR return of CI611 received by TACC SSR radar systems was at 1528:03, and the last SSR return received by the Xiamen radar was at 1528:14.

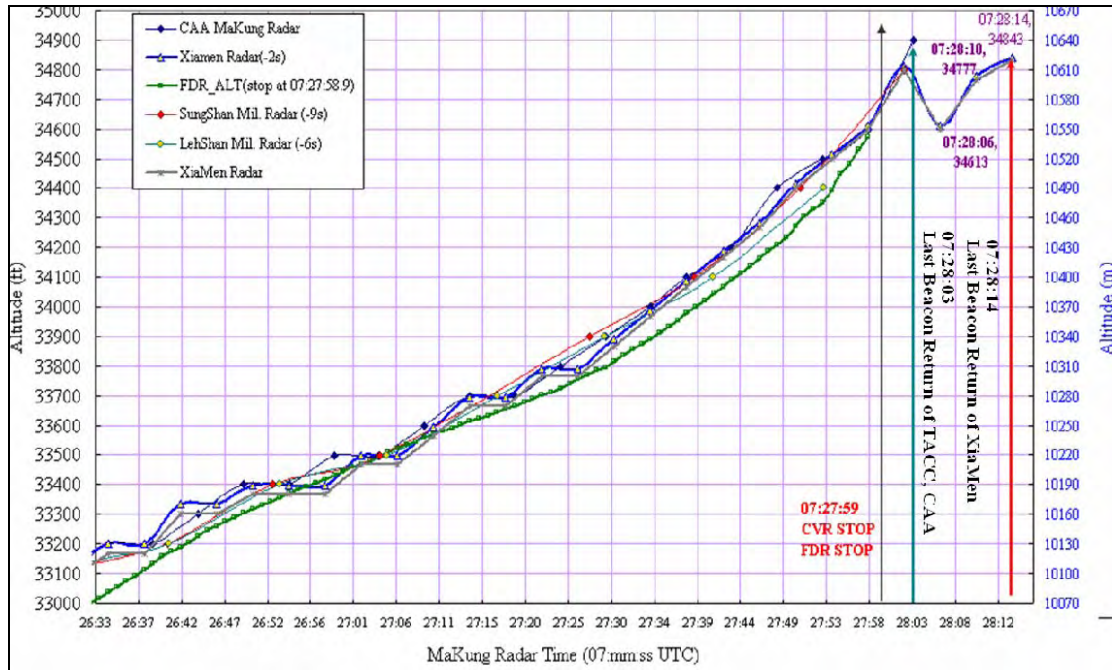

Figure 1.8-4 CI611 Mode-C altitude returns, and the FDR recorded altitude

### 1.8.6 Primary Surveillance Radar Data

According to the Makung primary signal returns, first record was detected at 1528:08, and continued until to 1551:35. During this period, the primary signal returns were separated into four groups. Figure 1.8-5 displays the time history plot of CI611 radar track and primary returns. Figure 1.8-6 shows the last six SSR data and three minutes of PSR data. Both Figures 1.8-5 and 1.8-6 are in UTC time.

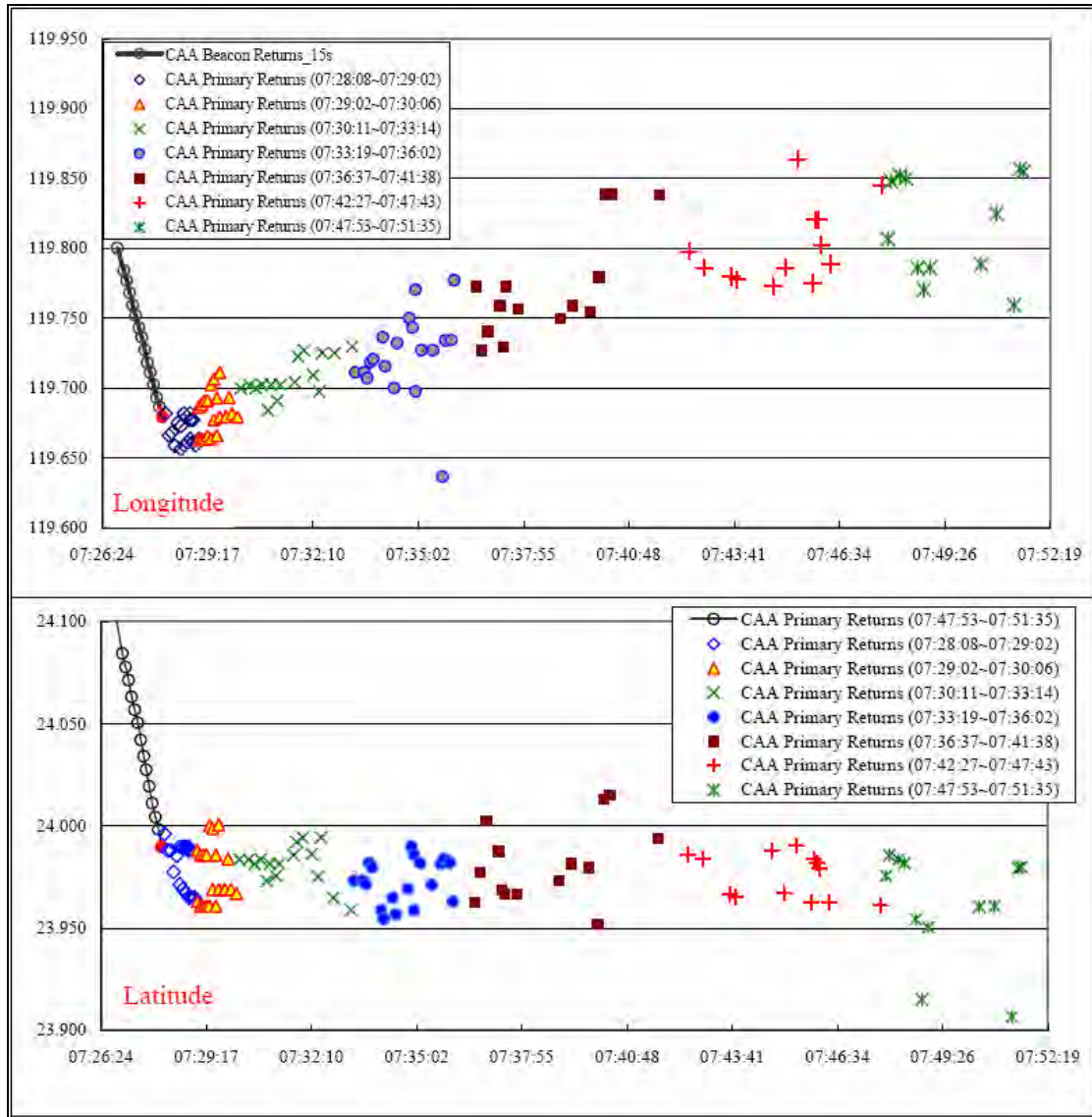

Figure 1.8-5 Time history of Cl611 radar track and primary signal returns

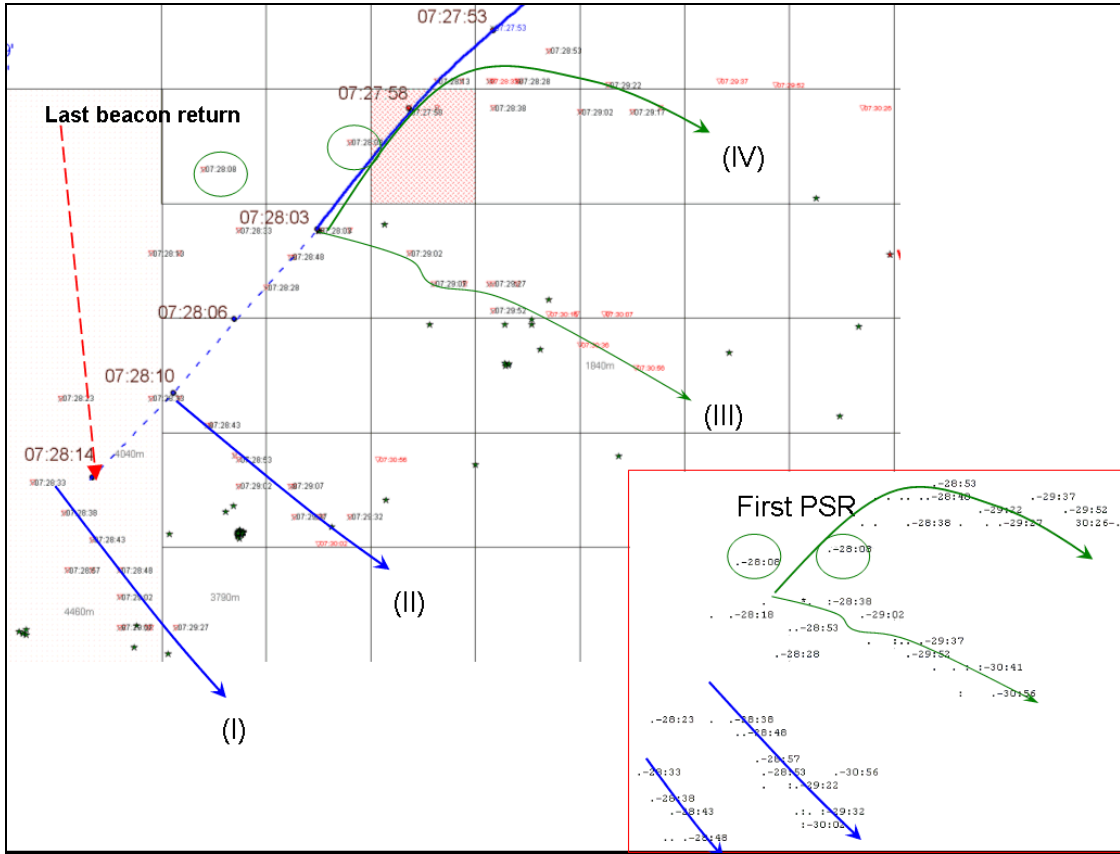

Figure 1.8-6 CI611 radar track, PSR returns and wreckage position

## 1.9 Communications

There was no reported communication problem between CI611 and ATC facilities.

## 1.10 Airport Information

Not applicable.

## 1.11 Recorders

The aircraft was equipped with both Cockpit Voice Recorder (CVR) and Flight Data Recorder (FDR) as required by the regulations. These two recorders are installed just aft of the rear-most cabin door, on the port side of the fuselage wall, in an area accessible from the cabin.

### 1.11.1 Cockpit Voice Recorder

The Fairchild model A100A CVR, serial number 60156, was recovered from seabed of the Taiwan Strait at position (23°58'58.61"N, 119°41'36.74"E) on June 18 2002. The recorder was transported in a water cooler filled with fresh water (as shown in Figure 1.11-1) to Aviation Safety Council laboratory on June 19 2002. Quality of the recording was good and a transcript was prepared of the entire 31 minutes and 51 seconds as shown in Appendix 9.



Figure 1.11-1 Damaged CVR in the water cooler

The recording tape consisted of four channels of good quality audio information. One channel contained the cockpit area microphone audio information. The other three channels contained the Captain's, the First Officer's, and the Flight Engineer's radio/intercom audio information.

The recording started at 1456:12<sup>16</sup> and continued uninterrupted until 1528:03. The last three seconds of CAM (Cockpit Area Microphone) spectrum analysis signature from CVR recording is shown in Appendix 10.

### 1.11.2 Flight Data Recorder

The accident aircraft was equipped with a Lockheed model 209F FDR, part number 10077A500-107, serial number 2537, which was configured to record 21 parameters as listed in Appendix 11. The FDR was recovered from the seabed of the Taiwan Strait on June 19 2002 at position (23°58'58.46"N, 119°41'17.71"E). The enclosure was immediately transported to the Aviation Safety Council laboratory in a water cooler filled with fresh water as shown in Figure 1.11-2.

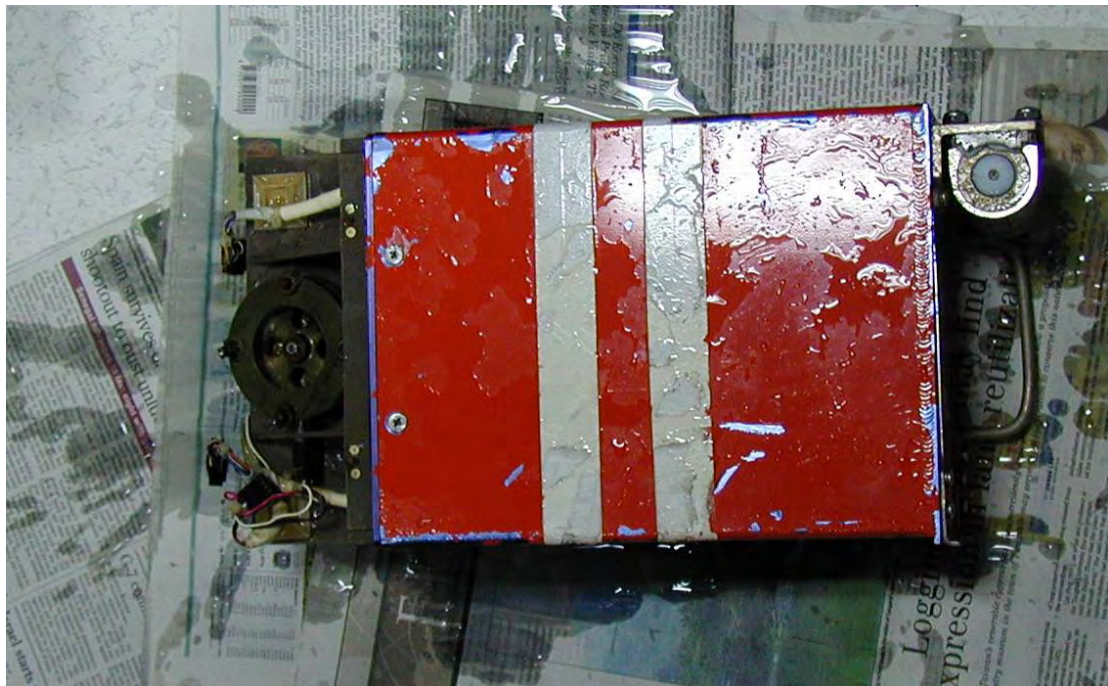

Figure 1.11-2 Damaged FDR in the water cooler

Upon arrival, the FDR enclosure was open immediately and the magnetic tape was found damaged. Pictures of the damaged FDR tape are shown in Figures 1.11-3 and 1.11-4. There are six crinkle marks on the tape.

---

<sup>16</sup> The time reference is based on the Makung radar site time.

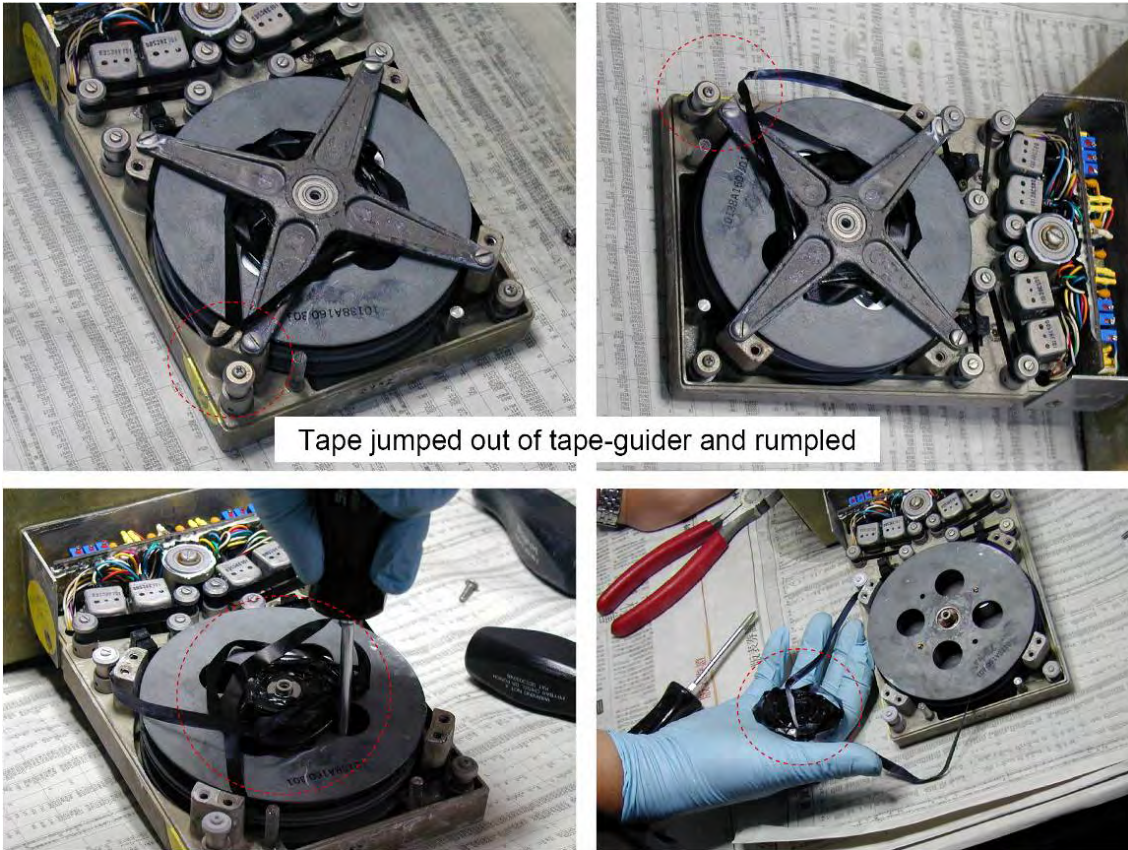

Figure 1.11-3 Photographs of damaged magnetic tape

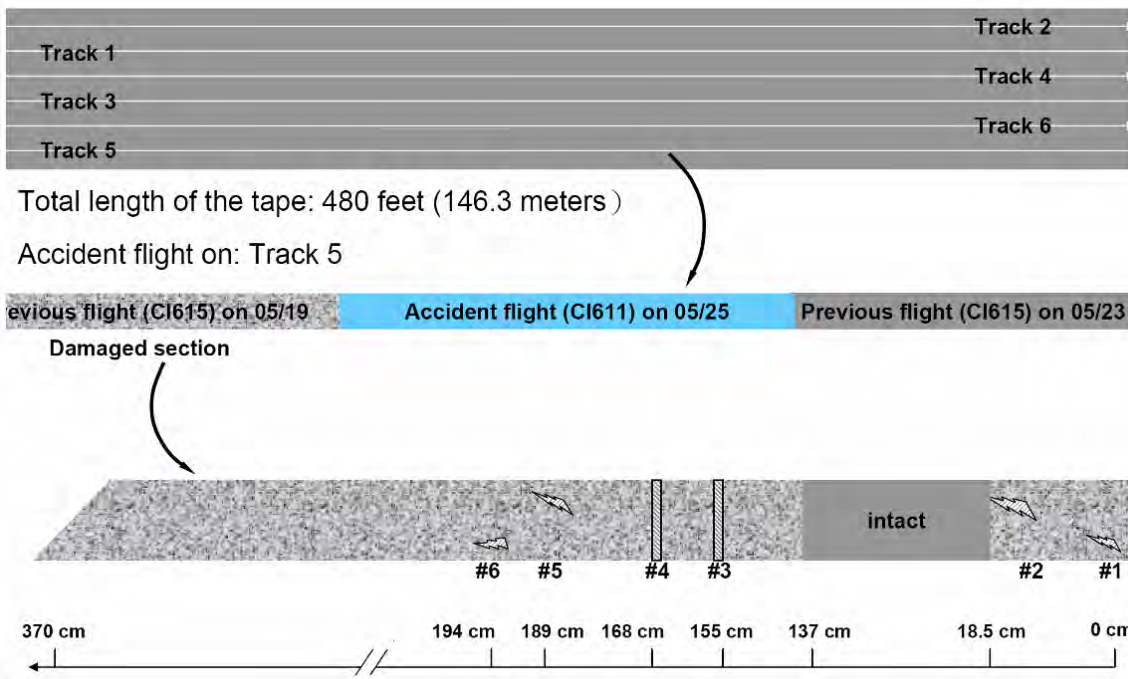

Figure 1.11-4 Sketch of damaged tape locations and conditions

Even though the case and part of the tape were damaged, data was retrieved and analyzed. Examination of the data indicated that the FDR had operated normally for the C1611 portion of the flight. About 32 minutes of data were transcribed for the accident flight.

The FDR records information digitally on a 0.25 inch-wide magnetic tape that has a recording duration of 25 hours before the existing data are overwritten. There are 6 distinct, individual tracks written bi-directionally. It contains approximately 4.17 hours of data on each track until reaching end-of-tape, then reverses direction, changes to another recording track, and writes data in the reverse direction. With this method, the FDR records even-numbered tracks in one direction, odd-numbered tracks in the opposite direction.

Tabular sets and plots of selected FDR parameters for the approximately 32 minutes of recorded data of the accident flight (1456:26 to 1527:58) were prepared from the readout. The plots of selected parameters covering the entire C1611 accident flight are shown in Appendix 12.

### **1.11.3 Wind Profile Collected from FDRs of Other Aircraft**

The FDR data from two flights in the general vicinity and time of the accident flight were analyzed for the development of a wind profile for comparison with the ground-based weather data (MM5). The comparison showed that the airborne wind profiles were generally consistent with the ground-based data.

## 1.12 Wreckage and Impact Information

### 1.12.1 Introduction

Wreckage was recovered both floating and from the floor of the Taiwan Strait. The wreckage field on the ocean floor was divided into four different areas designated as red, yellow, green and blue. The colors have no significant in themselves, other than for the planning purpose and as a convenient way of differentiating recovery location. The different zones are shown in Figure 1.12-1.

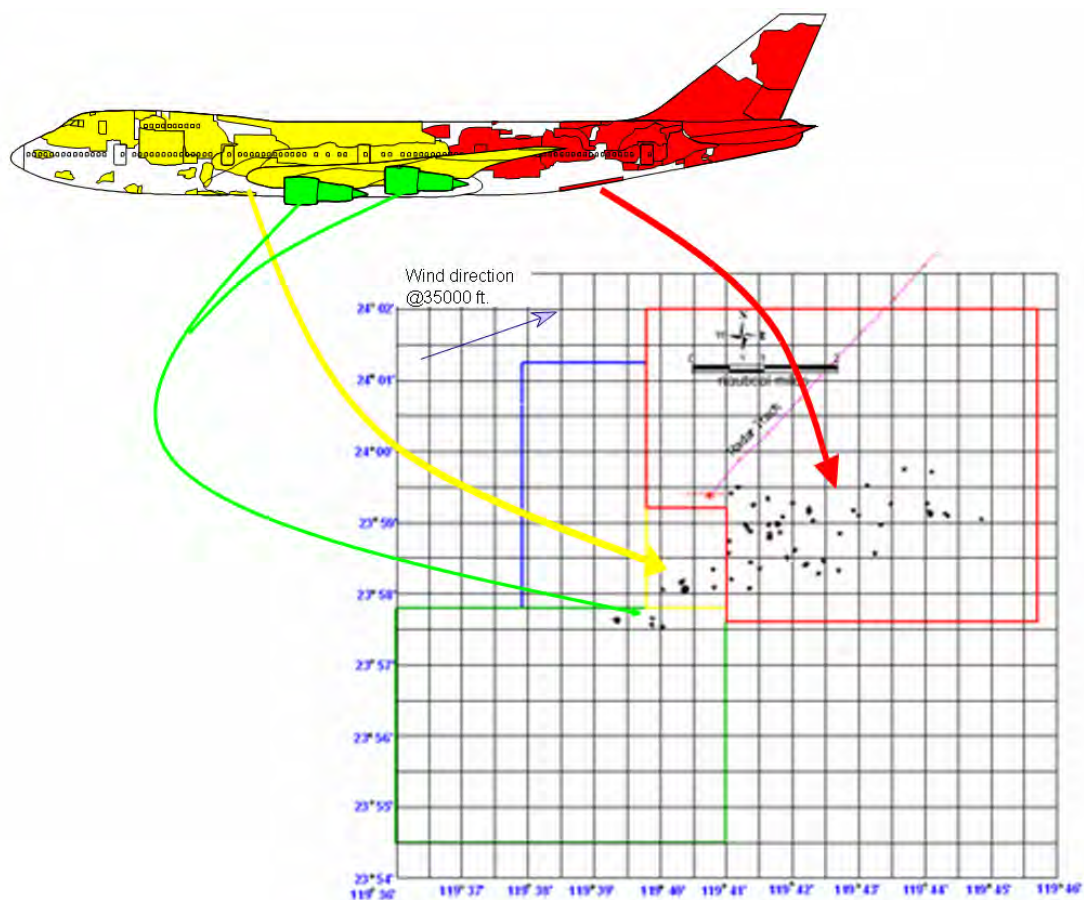

Figure 1.12-1 Four distinct wreckage recovery zones

Once a wreckage piece was recovered, either floating or from the seabed, a number was immediately assigned in numeric order. For instance, item 640C means this item was number 640 in the recovery sequence. The C number means that a particular piece has been cut because of testing, or for the convenience in shipping/transportation. Several batches of numbers were initially reserved for identifying the smaller wreckage pieces, but the numbers



were not used because the investigators determined that the small pieces did not justify individual identification by location or by means of recovery.

There are a total of 1,448 items have been numbered and stored in the ASC/CI611 database (Appendix 13).

### **1.12.2 Forward Body - Sections 41/42/44**

This section details the wreckage from sections 41/42 (the fuselage structure forward of the wing) and section 44 (fuselage structure in the vicinity of the wing and main wheel wells). The majority of the recovered portions of sections 41/42/44 was found in the main debris field in the yellow zone within general vicinity and was relatively intact. All landing gear was found in main debris field except for the Right Body Gear, which was retrieved from the green zone (possibly dragged to the green zone by fishing boat)<sup>17</sup>. Also retrieved from the green zone were several portions of the STA 1480 bulkhead adjacent to the Right Body Gear support. The Wing Center Section (WCS) was also recovered in the main debris field. Many small fuselage fragments from the lower 41/42 sections were recovered but not documented and were not included in Figure 1.12-2.

The wreckage examinations of the wings, the four engines, and section 41, 42, and 44 have been described in the factual report published on June 3, 2003.

---

<sup>17</sup> Fishing net was found wrapped around it.

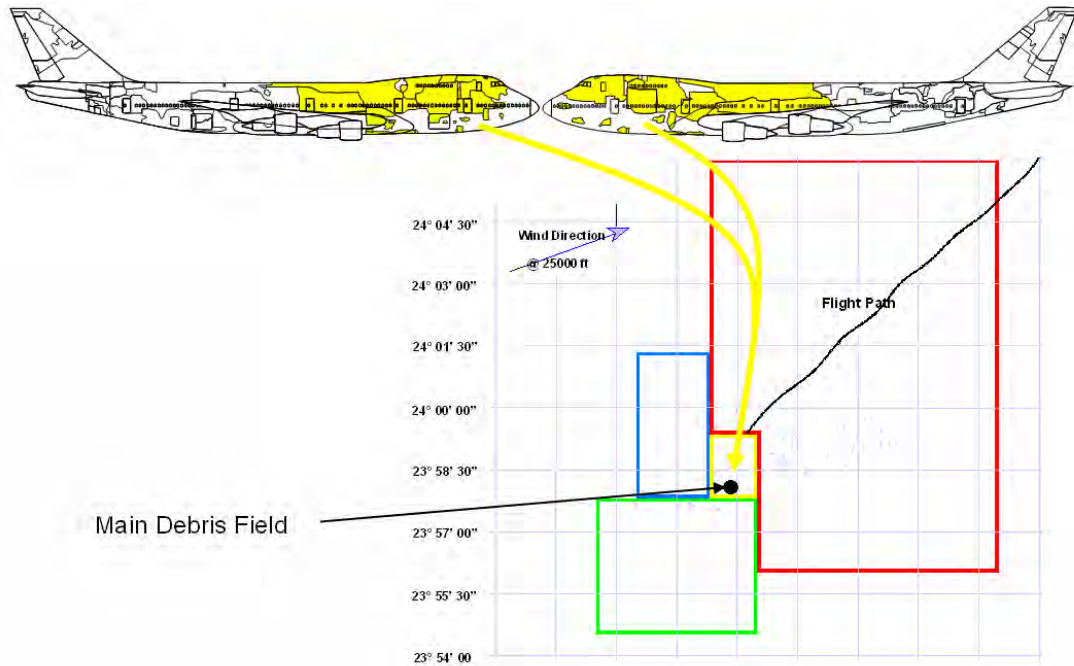

Figure 1.12-2 Majority portions of sections 41/42/44 found in yellow zone

### 1.12.3 Section 46

The majority of the section 46 wreckage (pressurized fuselage aft of the wing and wheel well area) was found in the red zone. Only two pieces of wreckage (items 626 and 659) extending from section 44 to 46 were found in the yellow zone. Those pieces of wreckage were distributed over a wide area with more than four miles in length (Figure 1.12-3). Detail of those pieces of wreckage was as follows.

#### 1. Aft Cargo Door

The aft cargo door was retrieved in the red zone in three major segments.

The upper portion of the door (item 723 in Figure 1.12-4 left) was recovered with the hinge intact and the actuators in the closed position.

The lower portion of the door (item 741 in Figure 1.12-4 right), including three forward pairs of latches, was recovered still latched and the locks engaged. Only a few pieces of the skin and stringers remained on the frames.

The lower aft portion of the door (item 2019 in Figure 1.12-5), including the aft pair of latches, was found separately. The lower portion of the door skin was bent

outboard approximately in 45 degrees. Examination of the hinge, latches, and the other mechanisms was consistent with the aft cargo door being closed at the time of the aircraft breakup.

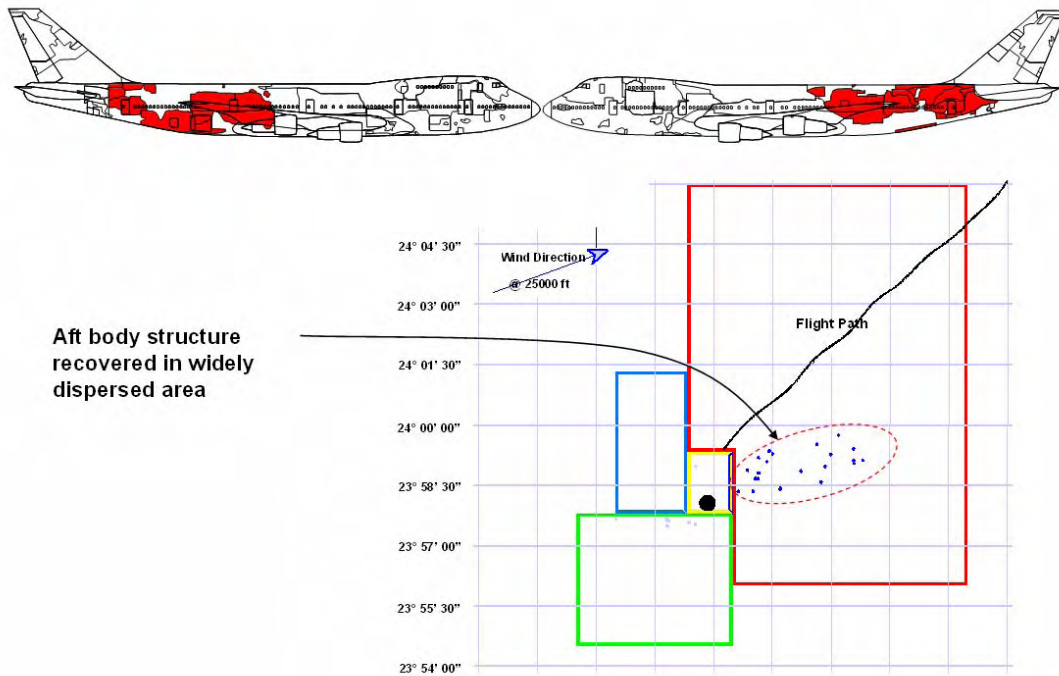

Figure 1.12-3 Section 46 wreckage distribution

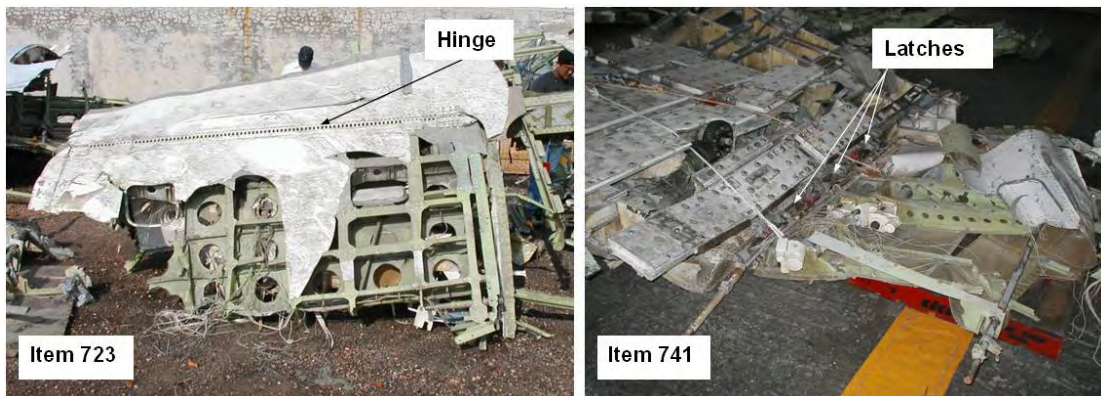

Figure 1.12-4 Item 723 (left) and item 741 (right)



Figure 1.12-5      Item 2019

## 2. Semi-Monocoque Structure

Only a portion of the skin, frames and stringers of the semi-monocoque structure of section 46 were found. Those pieces were arranged in a two dimension reconstruction (2D reconstruction) to assist in evaluating the fractures and deformations of the panels.

## 3. Item 640

Item 640 (Figure 1.12-6) was a piece of section 46 skin panel ranged from Body Station 1920 (STA 1920) to Body Station 2181 (STA 2181), Stringer 23 right (S-23R) to Stringer 49 left (S-49L) found along with a repair doubler installed from STA 2060 to STA 2180 and from one side between S-48L and S-49L to the other side between S-50R and S-51R (Figure 1.12-7). A flat-fracture surface (indicative of slow crack growth mechanisms) on the skin at the edge of the repair doubler near S-49L was found during the field examination. Item 640C1 and item 640C2 (as shown in Figure 1.12-6) were segmented from parent item 640 and then sent to Chung-Shan Institute of Science and Technology (CSIST) and Boeing Materials Technology (BMT) for further examination and tests. Details of the examination results are shown in section 1.16.3.

Also included in item 640 is the bulk cargo door. The segment was recovered with the door closed and latched. The lower portion of the bulk cargo door seal protruded through the space between the door and the sill.

The forward portion of item 640 includes the aft portion of the aft cargo door cut out frame. There are deformations at the lower latch fitting attachment location.

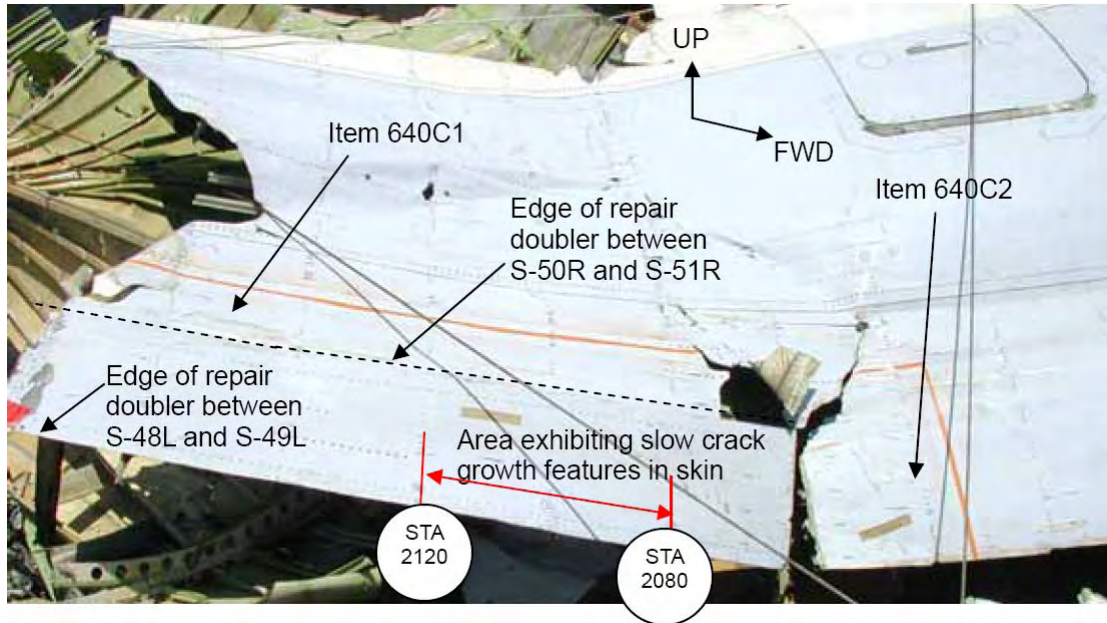

Figure 1.12-6 Item 640

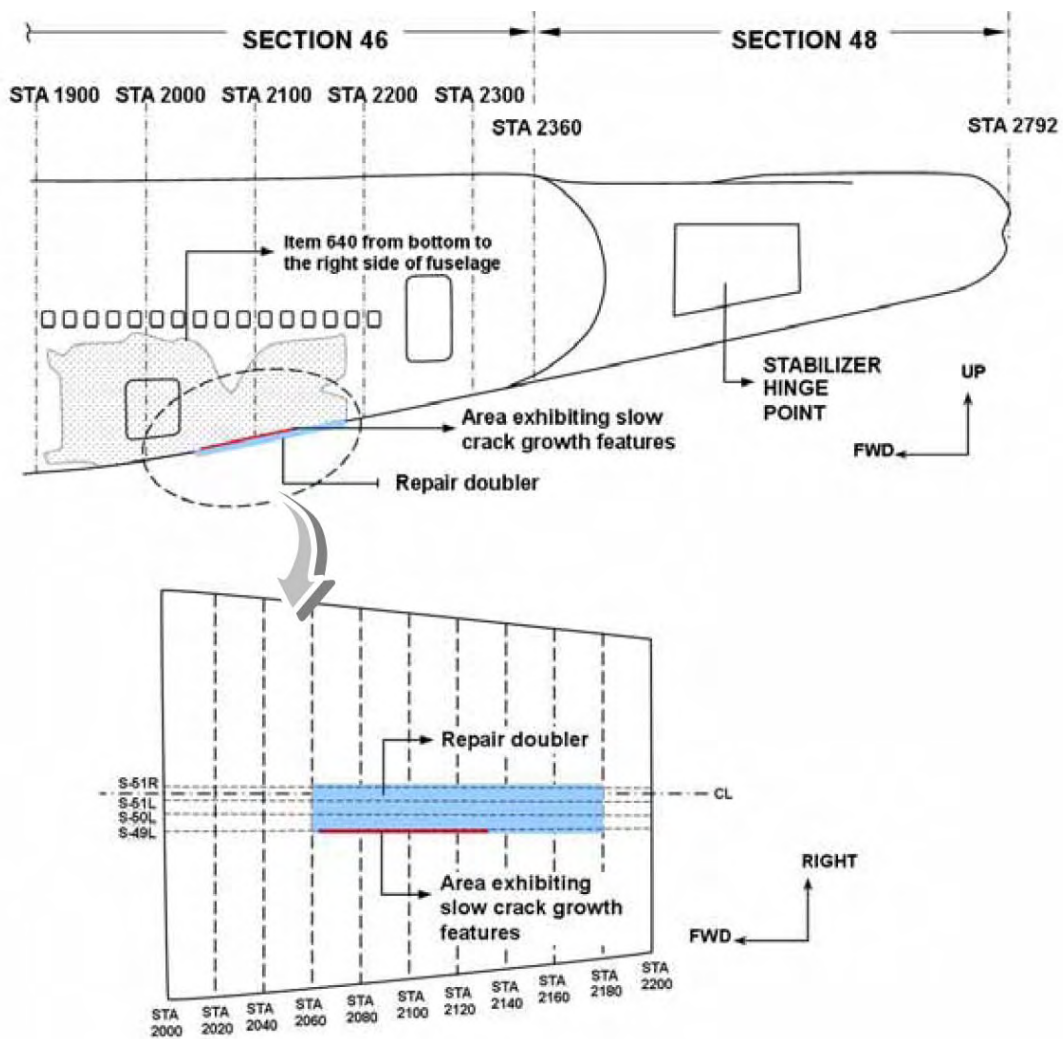

Figure 1.12-7 Item 640 and the repair doubler

## 1.12.4 Empennage and Section 48

The section 48 and empennage structure (the aft pressure bulkhead and all structure aft) was found in the red zone (Figure 1.12-8). The horizontal stabilizer, the majority of the skin/stringer/bulkhead structure, and the lower third of the vertical fin were found attached with very little damage (Item 630, Figure 1.12-9).

Some fin structure, including leading edge structure and the fin cap (items 22, 23, and 960) were recovered as floating debris. A large upper portion of the fin and rudder was found separate from item 630.

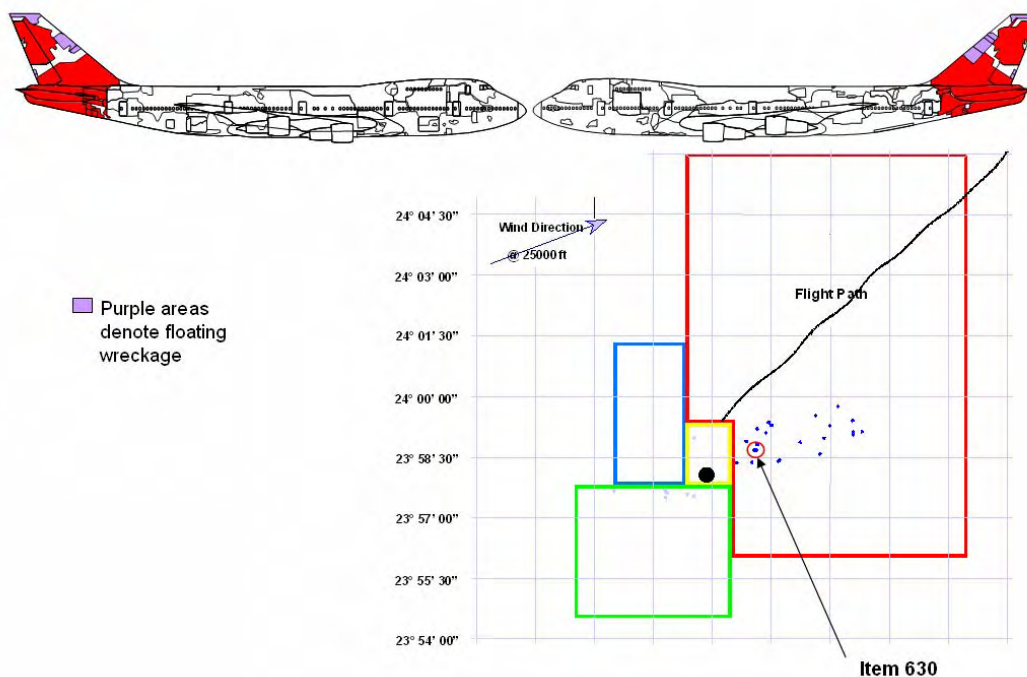

Figure 1.12-8 Section 48 and empennage structure found in the red zone

### 1. Horizontal Stabilizer

The right horizontal stabilizer (RHS) is considerably more damaged than the left horizontal stabilizer (LHS). The inboard portion of the RHS leading edge is deformed upwards. At the root of the RHS, the inboard 10 feet showed considerable impact damage along with upwards deformation of the compromised structure. A portion of seat support was found inside a puncture common to the lower surface of the LHS. A small segment of fuselage stringer was also found imbedded in the RHS elevator (Figure 1.12-10 left-down). A small fastener and shim from a stowage bin assembly were found inside a puncture common to the RHS leading edge (Figure 1.12-10 right).



Figure 1.12-9 Item 630



Figure 1.12-10 A small segment of fuselage stringer imbedded in the RHS elevator (left-down). A small fastener and shim were found inside the RHS leading edge (right).

## 2. Vertical Fin

The majority of the upper portion of the vertical fin (item 2035, as shown in Figure 1.12-11) was found separate from the remaining section 48 debris, but also in the red zone. The forward edges of item 2035 were deformed to the left side. The lower edge of this piece exhibited signs of bending and separation to the left side. At the upper forward edge of item 2035, there was significant tearing damage from fore to aft and right to left.

The middle portions of the vertical fin leading edge (items 22, Figure 1.12-11, item 23, 170, 350, and 392) were found floating. There were puncture marks evident on the RHS of these pieces. The vertical fin cap (item 960) was also found floating.

The lower portion of the vertical fin remained attached to the majority of section 48 and is now identified as item 630C1 (Figure 1.12-12) after being cut near the base to facilitate transportation. Two small stringer segments were found inside the leading edge portion of the fin adjacent to two punctures on the RHS. These stringer segments (items 630C4 and 630C5) originated from a section 46 fuselage belly panel. Item 630C4 is confirmed to be from STA 2170 at S-38R and the characteristics of item 630C5 indicate it is from STA 2170 at either S-42R or S-44R. Residue on the forward fracture face of these stringer segments indicates they entered the fin forward end first. The fractures and adjoining skin on item 630C1 contained deformation consistent with the upper portion of the vertical fin bending to the left.

The lower portion of the fin (item 630C1), the upper portion of the fin (item 2035), and several of the floating pieces (item 22) show similar evidence of impact damage on the right side.

The entire empennage separated from section 46 forward of the aft pressure bulkhead at STA 2360. A large portion of the section 48 structure (including items 630-632, 641, 644, 646-648, 765, 766, 772, 773, 938, 939, 943, 944, and 2013) from the aft pressure bulkhead was found in the red zone within close proximity. The aft pressure bulkhead lower half was compressed upwards. The fuselage frames from the aft pressure bulkhead to the horizontal stabilizer jackscrew were pushed aft and fractured, predominantly on the RHS.



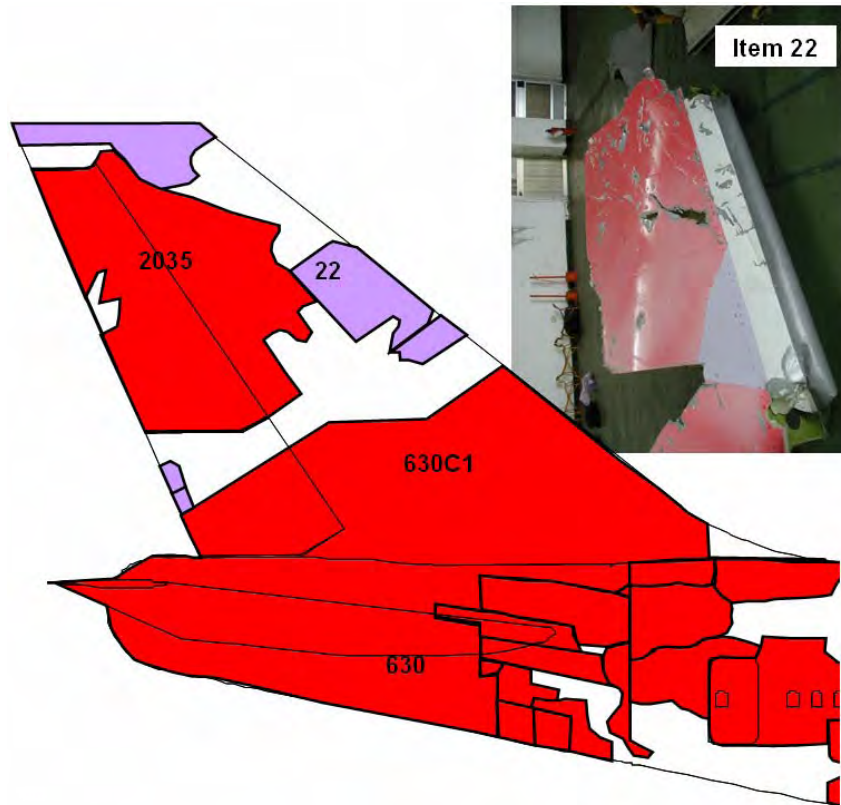

Figure 1.12-11 Vertical fin and item 22

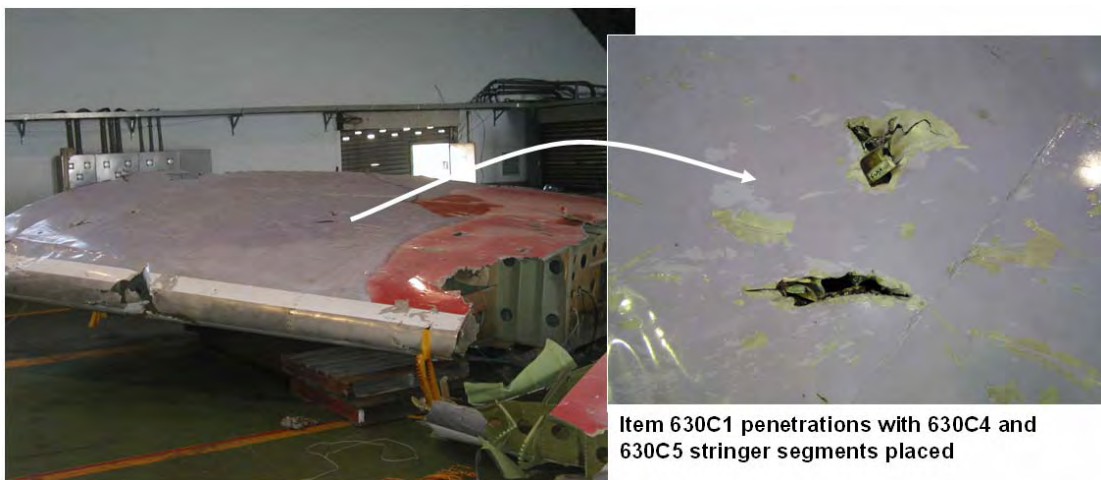

Figure 1.12-12 Item 630C1

### 3. Section 48 Belly Area

The belly area of item 630 between STA 2484 to STA 2658 was examined, and two adjacent doublers were removed during wreckage examination as shown in Figure 1.12-13.

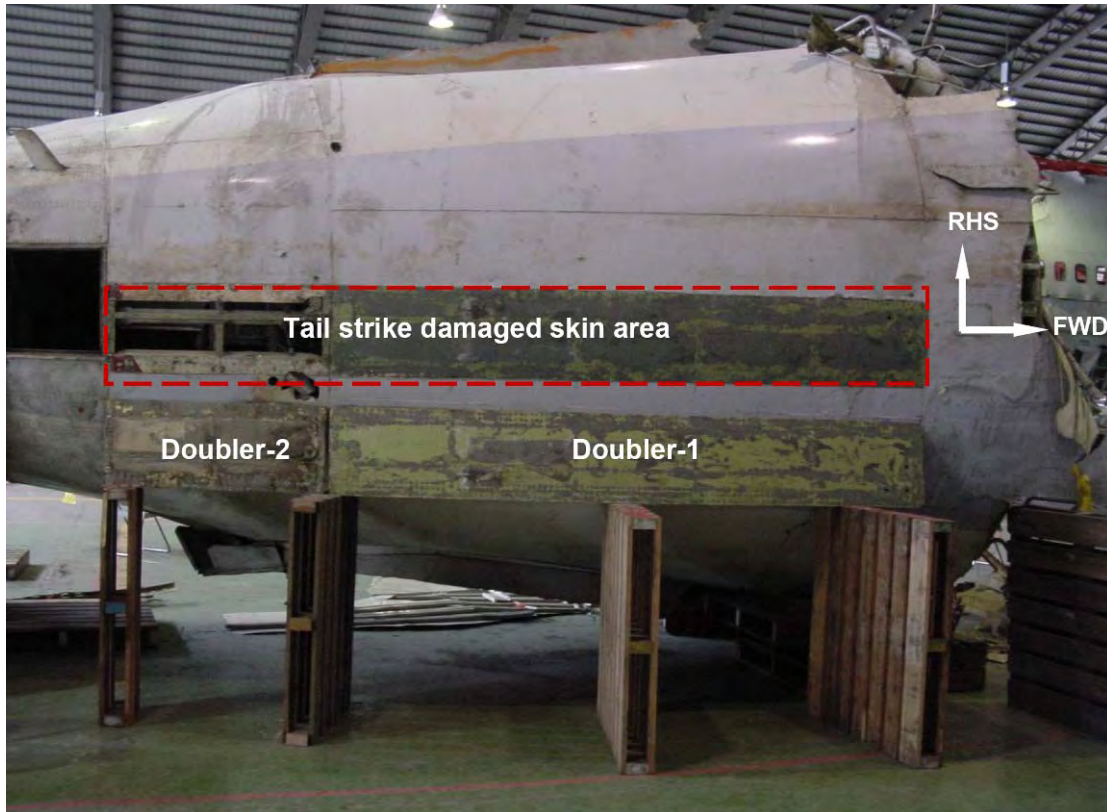

Figure 1.12-13 Doublers in section 48

The B-18255 Aircraft Log Book stated the belly skin area between STA 2578 to STA 2638 had serious abrasion damage. Examination of the skin underneath the two doublers revealed that, skin underneath Doubler-1<sup>18</sup> (STA 2484 to 2598) had damage consisting of fore to aft (longitudinal) scratching with the most severe scratching at the locations of skin stiffening members. The damaged area had not been cut out or removed (trimmed), however, blending was found over much of the repair surface. Skin beneath the Doubler-2 (STA 2598 to STA 2658) was cut out as shown in Figure 1.12-13.

Doubler-1 was applied over scratches similar to the item 640 repairs. The depth of the scratches was measured with the maximum depth of 0.0083 inch at STA2552.4 and near S51L. The schematic (Figure 1.12-14) depicts the extent of damage and general condition. Main damaged area (Scratch-1) starts from STA 2484 around S51L with the width of approximately 7 inches. At STA 2575.2, the area is 3 inches in width, and ends at STA 2598. Scratch-2 is in vicinity of S49L

---

<sup>18</sup> The doubler numbers named here are different from the numbers used in the doubler mapping during CAL RAP preparation in November 2001

and starts from STA 2535 with the length of 42 inches. No evidence of crack was identified in this region. There are dents at STA 2567 and STA 2610, which was the result of wreckage handling.

It was noted that the former topcoat, enamel and primer (original painting before the skin repair) remained on the skin covered by Dubler-2.

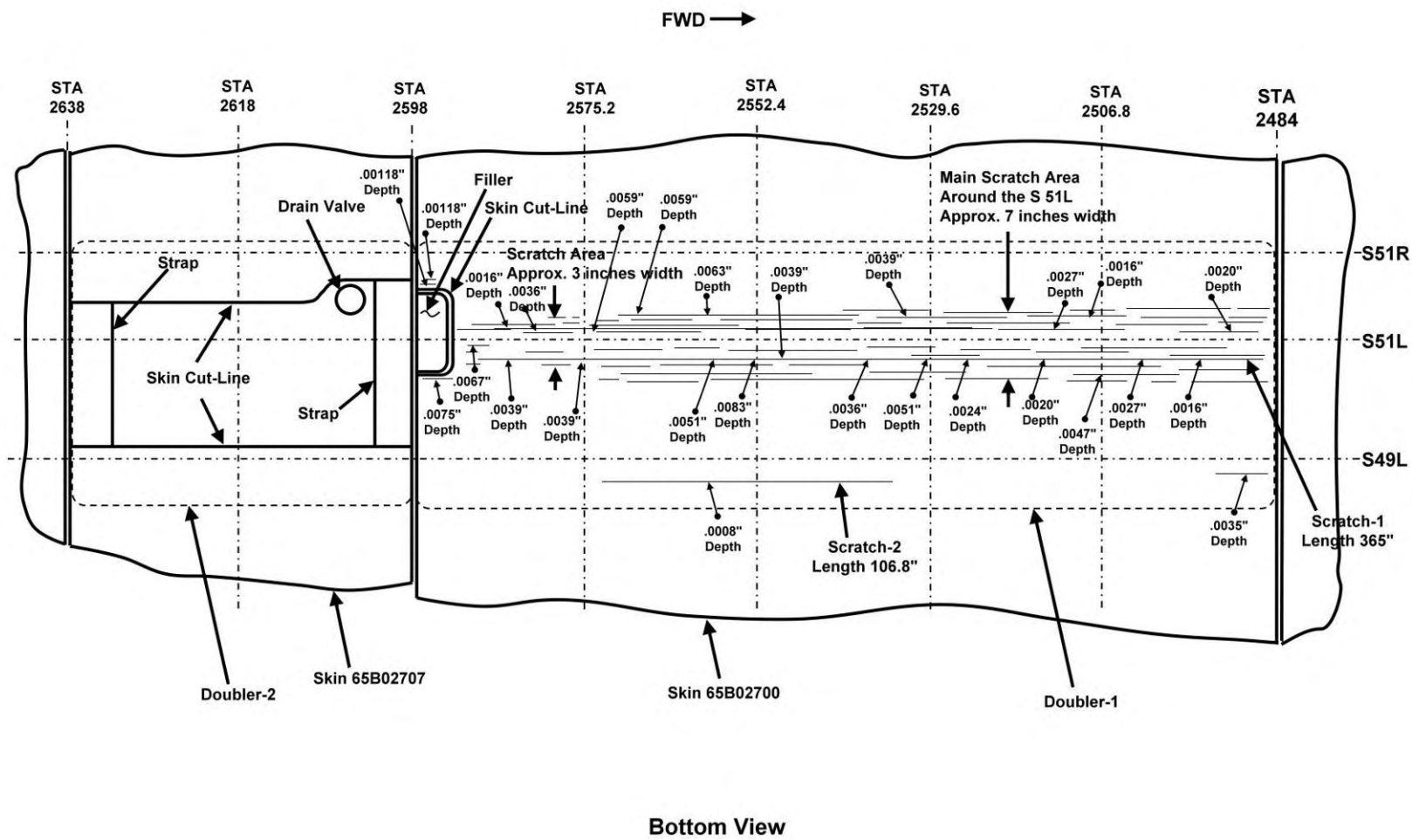

Figure 1.12-14 The schematic diagram of the doublers in Section 48

### 1.12.5 Strut Structure and Engines

All four engines were recovered in a relatively concentrated area as shown in Figure 1.12-15. A significant portion of the engine support structure remained attached to the left and right wings. All recovered fuse pins remained intact. Since examination of the four engines and their strut structure has been described in detail in the factual report, it will not be repeated here.

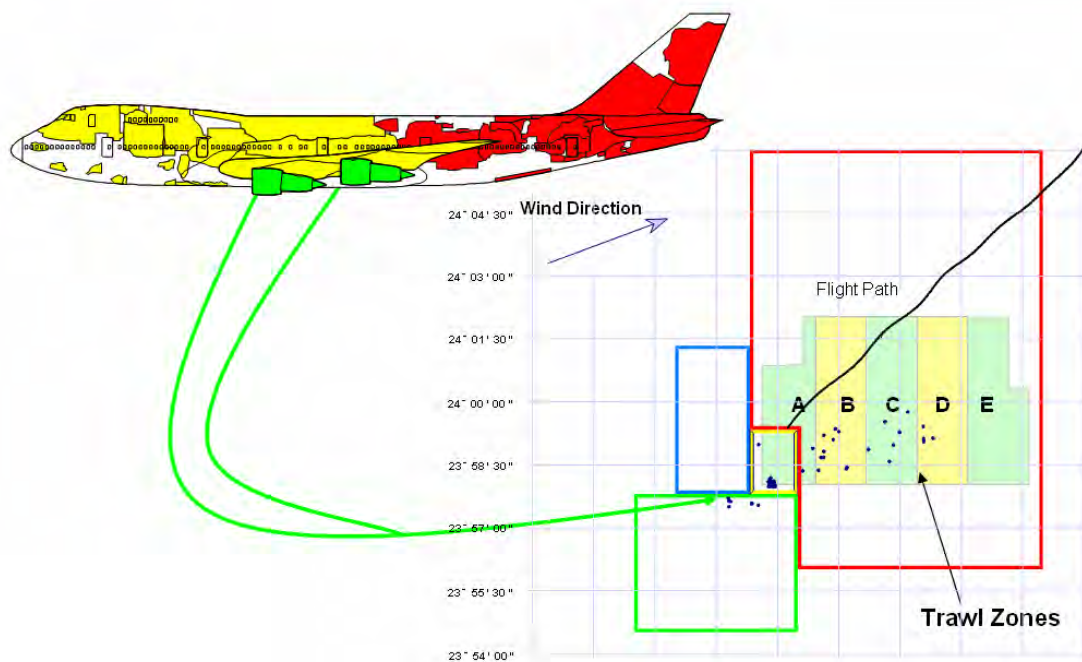

Figure 1.12-15 All engines were recovered in a relatively concentrated area

### 1.12.6 System Components

This section contains detailed descriptions of the following components:

Flight Engineer's Instruments and Controls

Dado Vent Modules (Pressure Control and Relief Components)

The cockpit section was recovered relatively intact (Figure 1.12-16). The pilots' and the flight engineer's instrument panels remained attached to the cockpit section with wire bundles. The entire cockpit section was brought to the dock. Later, the cockpit section was lifted with a crane and the instrument panels were removed.



Figure 1.12-16 Cockpit section

### 1.12.6.1 Flight Engineer's Instruments and Controls

Flight Engineer Panel is shown in Figure 1.12-17.

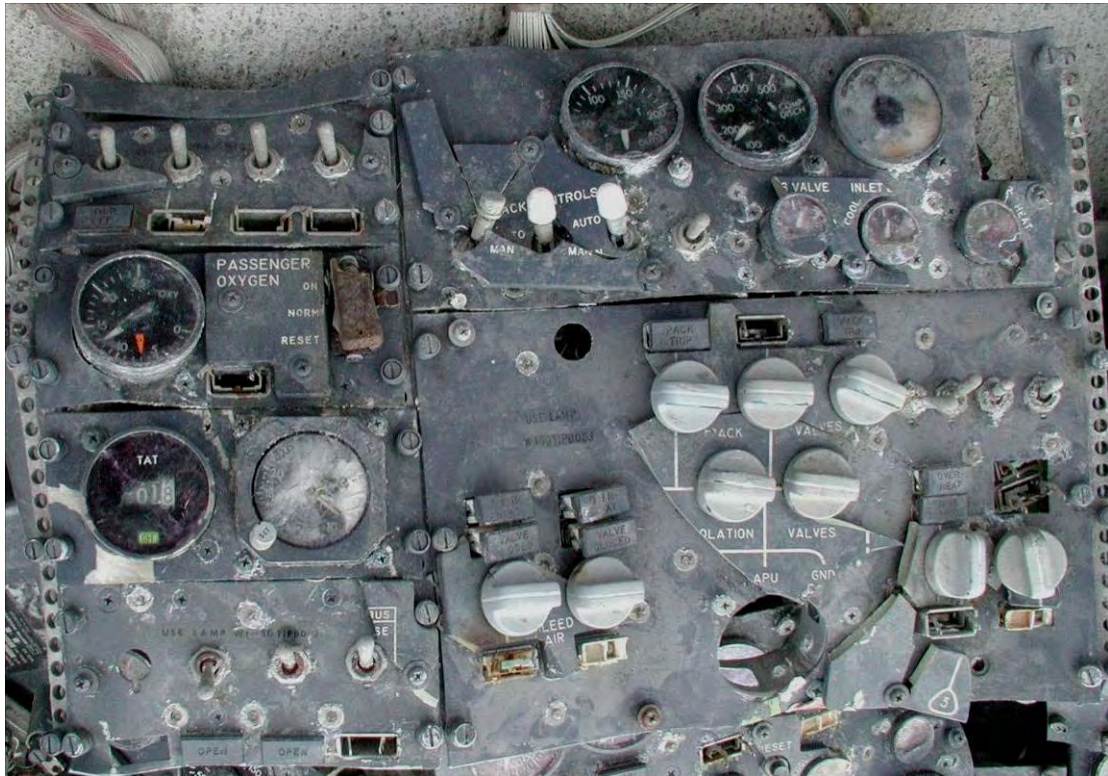

Figure 1.12-17 Flight engineer panel

### **APU Panel**

Bleed Air switch was found in OPEN.

### **Cabin Altitude control Panel**

- Cabin Vertical Speed Indicator: Needle: 500 FPM Climbing.
- Cabin Altitude Needle: 9 o'clock.
- Cabin Altitude Window: 3000.
- Differential Pressure Needle: 12 o'clock (0.0 psi).

### **Cabin Pressure Control Selector Panel**

- MODE SELECT switch was found in MAN (manual) mode.
- The ALTITUDE tape was delaminated and partially missing.
- Both OUTFLOW VALVES indicator needles were found detached from their respective internal armature/wiper attachment mechanisms.

### **Air Conditioning (Pack Control) Panel**

- The three PACK VALVES switches were found in the OFF position.
- Engine numbers 1 and 2 BLEED AIR switches were found in the OFF position.
- Engine numbers 3 and 4 BLEED AIR switches were found in the ON position.

### **Oxygen control panel (module M183)**

- PASSENGERS OXYGEN needle at 700 psi. (which was disconnected from its driving rod either during or before disassembly).
- PASSENGER OXYGEN control switch was found in NORM position. Switch is functional.
- Switch guard breakaway wire is broken.
- Switch guard is damaged with portion missing.

### **Clock**

Clock reads 0722.

### **1.12.6.2 Dado Vent Modules**

Dado vent modules are installed in the lower portion of the passenger cabin sidewalls, just above the floor at selected locations throughout the aircraft (Figure 1.12-18). The vent box modules incorporate a dado panel and a louvered air grille as part of a hinged and spring-loaded door. In normal operation, the hinged door is held in the closed position by an over-center valve mechanism (Figure 1.12-19). Normal airflow between the main deck and lower lobe is through the air grille louvers. In the event of rapid cabin decompression originating in the lower lobe, additional venting area is required to prevent an excessive buildup of pressure across the main deck floor. Between 0.2 and 0.5 psi, the differential pressure between the main deck and lower lobe will trip the valve and the hinged door will swing open into the sidewall to provide additional venting area. Once open, the hinged door will remain in the open position until each individual door is manually reset.



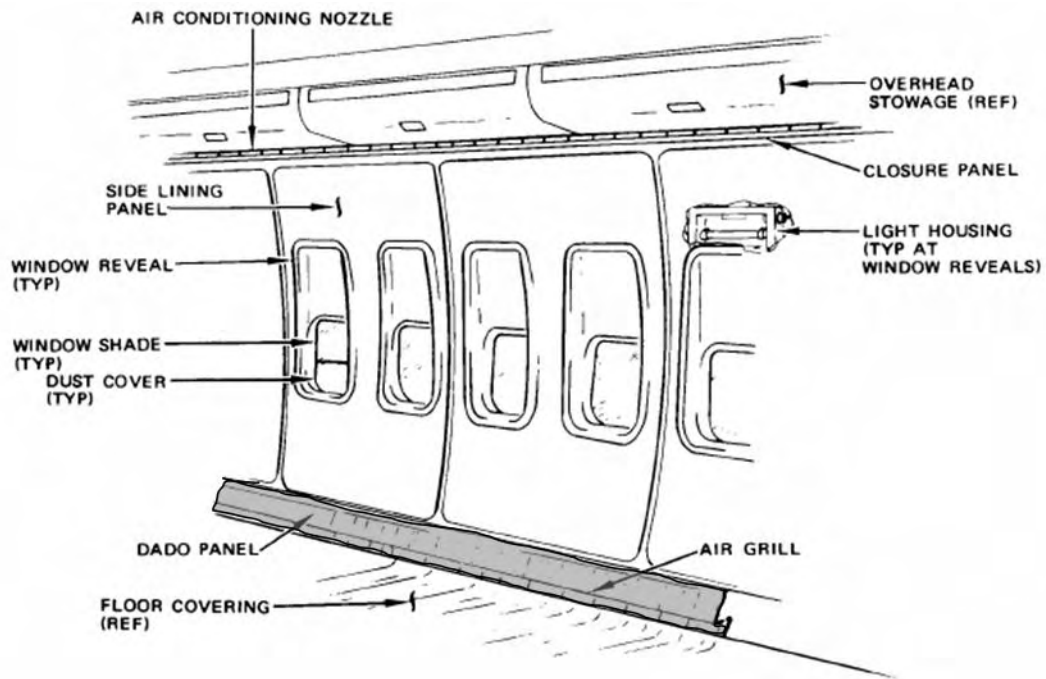

Figure 1.12-18 Dado vent modules

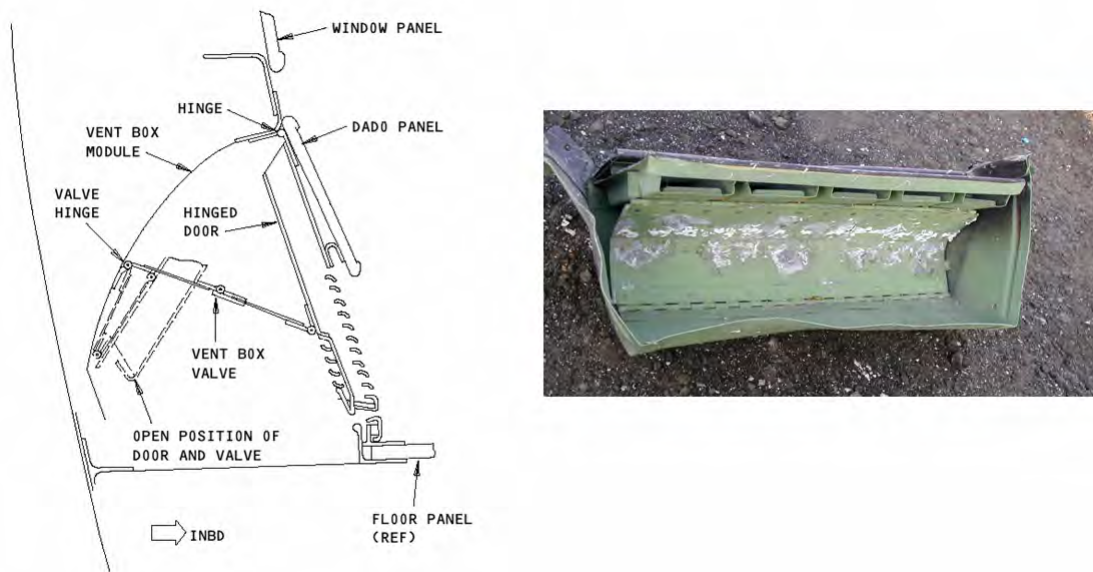

Figure 1.12-19 Typical dado vent modules in closed position

A total of 65 movable dado vent modules were installed on the accident aircraft of which 19 (29.2%) were recovered. Table 1.12-1 shows the distribution of installed and recovered movable dado vent modules.

Table 1.12-1 Distribution of installed and recovered movable dado panels

<b>Dado Vent Modules</b>	<b>A Zone</b>	<b>B Zone</b>	<b>C Zone</b>	<b>D Zone</b>	<b>E Zone</b>
<b>Number Installed</b>	9	11	8	12	25
<b>Number Recovered Closed</b>		4	4	-	-
<b>Number Recovered Open</b>	-	-	-	2	2
<b>Number Recovered Unable Verify</b>	5				2
<b>Percentage of Recovery</b>	55.6%	36.4%	50.0%	16.7%	16.0%

## **1.13 Medical and Pathological Information**

CI611 had 3 flight crew seats and 2 observer seats in the cockpit (no observer was present on this flight), 16 cabin crew jump seats, 22 first class seats, 16 business class seats on upper deck, 30 business class seats and 288 coach class seats in the main deck. The cabin is divided into 6 zones – A to E on the main deck, and Zone UD on the upper deck as shown in Figure 1.13-1.

The seat assignment for each passenger was obtained from the CAL passenger manifest. However, some passengers might have changed their seats during boarding since the aircraft was not full. Cockpit flight crewmembers were seated according to their assigned positions. CAL provided seat assignments of the sixteen cabin crewmembers, however, according to CAL, the cabin crewmembers might have been out of their seats performing cabin service at the time of the accident.

### **1.13.1 Victim Recovery, Examination and Identification**

Of the 225 passengers and crew on board, remains of 175 were recovered and identified. The remains of the victims were recovered either by surface vessels, or by the wreckage recovery vessels. The first 82 bodies were found floating on the ocean surface of the Taiwan Strait and were recovered by fishing boats, Coast Guard and military vessels. Contracted recovery vessels were subsequently utilized for the recovery of the aircraft wreckage and the remaining victim bodies.

Each body was assigned a recovery number according to the order transported to the morgue (number 1 being the first body assigned). ASC investigators then correlated the bodies with their assigned seat (according to the China Airlines CI611 passenger manifest). The victim's bodies were photographed; their clothing and possessions were cataloged and returned to the victim's families. The victims were identified by visual identification, personal effects, fingerprints, dental examination and DNA testing.

The three recovered flight crewmember bodies were autopsied; none of the passenger or cabin crewmember bodies were autopsied. The ASC has no legal authority to require the local prosecutor to perform autopsy.

Ten bodies plus a few human remains of the cabin crewmembers and passengers were examined using X-ray in the makeshift morgue.

### **1.13.2 Toxicological Examination of Flight Crew**

The Makung Coroner and Dental Team collected specimens for toxicological examination from the Captain, the First Officer and the Flight Engineer. Specimens were submitted to the Institute of Forensics Medicine in Taipei for examination. The toxicological results for all submitted specimens were negative for all illicit drugs and over-the-counter medications.

### **1.13.3 Victims' Injury Information**

Injury data, pertinent recovery data and assigned seating locations were correlated for each identified victim. The investigation group members reviewed victims' records included the body diagrams, injury protocol, photographs of the bodies, documents related to the recovery and identification of the individuals.

Some of the victims had expansion of lung tissue, subcutaneous emphysema, bleeding on the nose and mouth. There was no carbon remains found on any of the recovered bodies or their clothes. No sign of fire burning and blast damage were found. Most of the victims had extensive injuries, and consistencies were found with head injuries, tibia and fibula fractures, significant back abrasion, right versus left sided injuries, pelvic injuries and other more traumatic injuries. In general, most of bodies were nearly intact except for fractured bones.

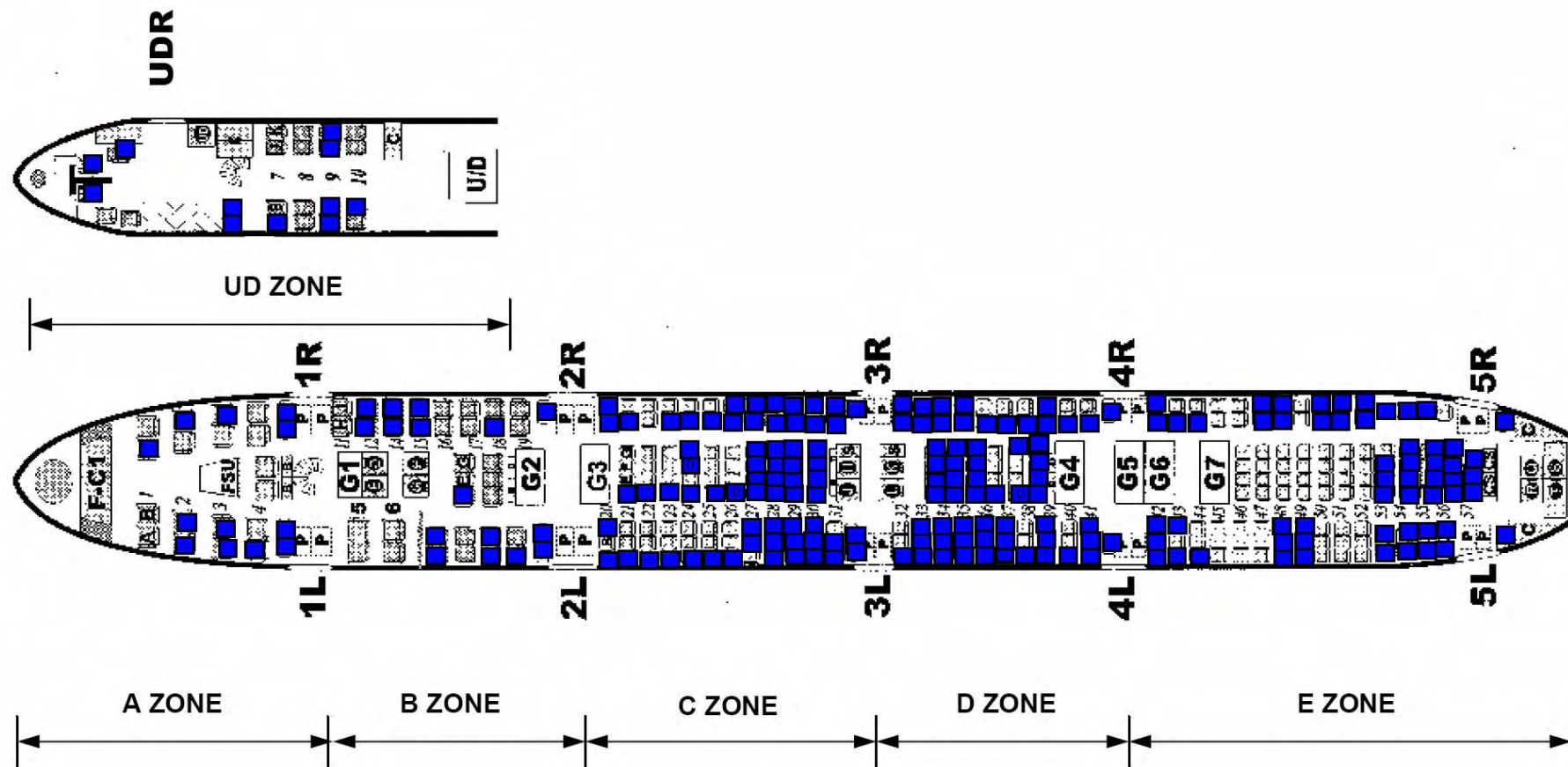

Figure 1.13-1 Cabin configuration and passenger seating assignment diagram

## **1.14 Fire**

No evidence of fire was found in this accident.

## **1.15 Survival Aspects**

This accident was not survivable.

## **1.16 Tests and Research**

### **1.16.1 Data Collection Flights**

On June 28, 2002, the Safety Council conducted a data collection flight utilizing a CAL B747-200 freighter aircraft. This data collection flight was for the purpose of recording cockpit instrument sound signatures to compare with the accident flight. Data relevant to the analysis of the CVR sound spectrum were obtained from this test flight. To obtain the sound of pressure relief valves opening during climb, on January 13, 2004, the Safety Council conducted another data collection flight also utilizing a CAL B747-200 freighter aircraft. The cabin was pressurized to 9.2 psid (differential pressure between cabin pressure and ambient pressure) as the altitude reached about 25,000 feet and the indicated airspeed about 300 knots. One valve opened and the other one remained closed. When the valve was opening, the test team in the cockpit could not hear the opening sound of the valve, but could feel the sound of the airflow as it appeared different from the sound prior to the opening.

### **1.16.2 Tests of the System Components**

On November 2, 2002, seven B-18255 aircraft systems components were sent to the Boeing Equipment Quality Analysis (EQA) laboratory in Seattle, Washington, for detailed examination. The EQA laboratory has specialized equipment and personnel to examine aircraft parts. ASC personnel, together with the personnel from Boeing, NTSB, and CAL participated in the examination. The key system components been tested including:

- Flight Engineer's Cabin Pressure Control Selector Panel (module M181)
- Air conditioning panel (module M170)
- Cabin Altitude Pressure Panel (module M170)
- Oxygen Control Panel (module M183)
- TAT and Clock (Module M184)
- DC Bus Isolation Panel (module M557)
- Pressure Relief Valves

The tests lasted for three days and the completed test result is shown in Appendix 14.

### **1.16.3 Examination of Item 640**

After the field wreckage examination, Item 640C1 and item 640C2 were sent to the metallurgical laboratory of CSIST and then to BMT for further test and examination.

The initial disassembly and the follow-on examination were conducted at CSIST. Other than the investigators from the Safety Council, personnel from NTSB, FAA, Boeing, CAA, and CAL all participated throughout the entire process. The examination lasted from July 31 to September 5 and examination report was documented as in Appendix 15. To further verify the results from CSIST, both 640C1 and 640C2 were sent to the BMT Laboratory of Boeing Commercial Airplane Company on November 2, 2002. The same group of specialists was present at this examination. The test and examination at BMT lasted from November 2 through 24, 2002 and the test report was documented as in Appendix 16. Another examination of the fretting marks on overhanging of the doubler faying surface (between holes +16<sup>19</sup> and 49) was conducted at CSIST with presence of CAA, ASC and CAL (Boeing and NTSB declined the invitation to attend) on September 14, 2004. The examination results are documented in Appendix 17.

The following sections summarized the results of the tests and examinations mentioned above.

---

<sup>19</sup> The rivets and holes along the fracture surface were numbered from +17 to 93 as shown in Figure 1.16-12 and 1.16-13 for reference.

### 1.16.3.1 Examination of the Skin

Item 640C1 was a segment of Item 640 approximately from STA 2060 to 2180 and from S-49L to S-49R (Figure 1.16-1). A 23-inch wide, 125-inch long external repair doubler was attached to the skin by two rows of countersunk rivets around its periphery as well as by fasteners common to the stringer and shear tie locations. Universal head rivets were used at S-51R and S-49L while countersunk rivets were used at S-50L and S-51L.



Figure 1.16-1 Exterior (up) and interior (down) of Item 640C1



After disassembling the doubler from the skin and removal of the protective finishes, scratching damage was noticed on the faying surface of the skin (Figure 1.16-2). This damage consists of primarily longitudinal scratching distributed in an area of 120 inches by 20 inches. The most severe scratching typically occurred at the skin stiffening members such as skin stringers and body frame shear ties. Evidence of an attempt to blend out these skin scratches, in the form of rework sanding marks, was noted over much of the repair surface. A close view of the skin area near STA 2080 is shown in Figure 1.16-3.

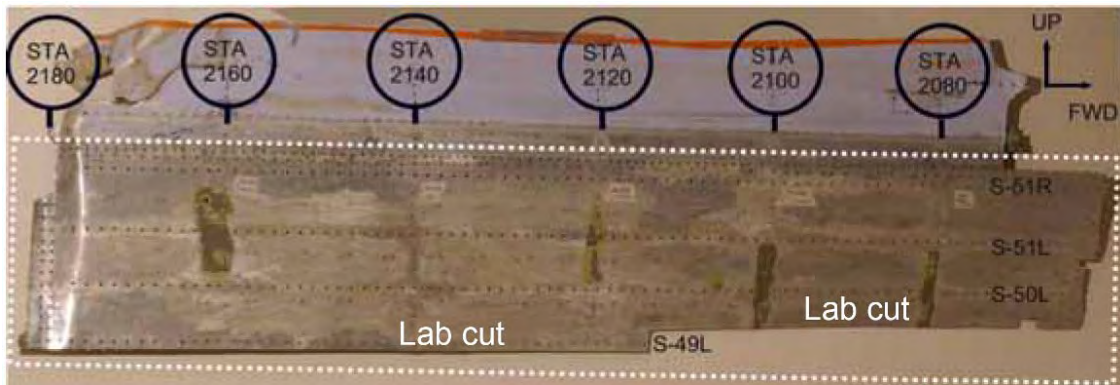

Figure 1.16-2 Faying surface with the repair doubler and protective finishes removed

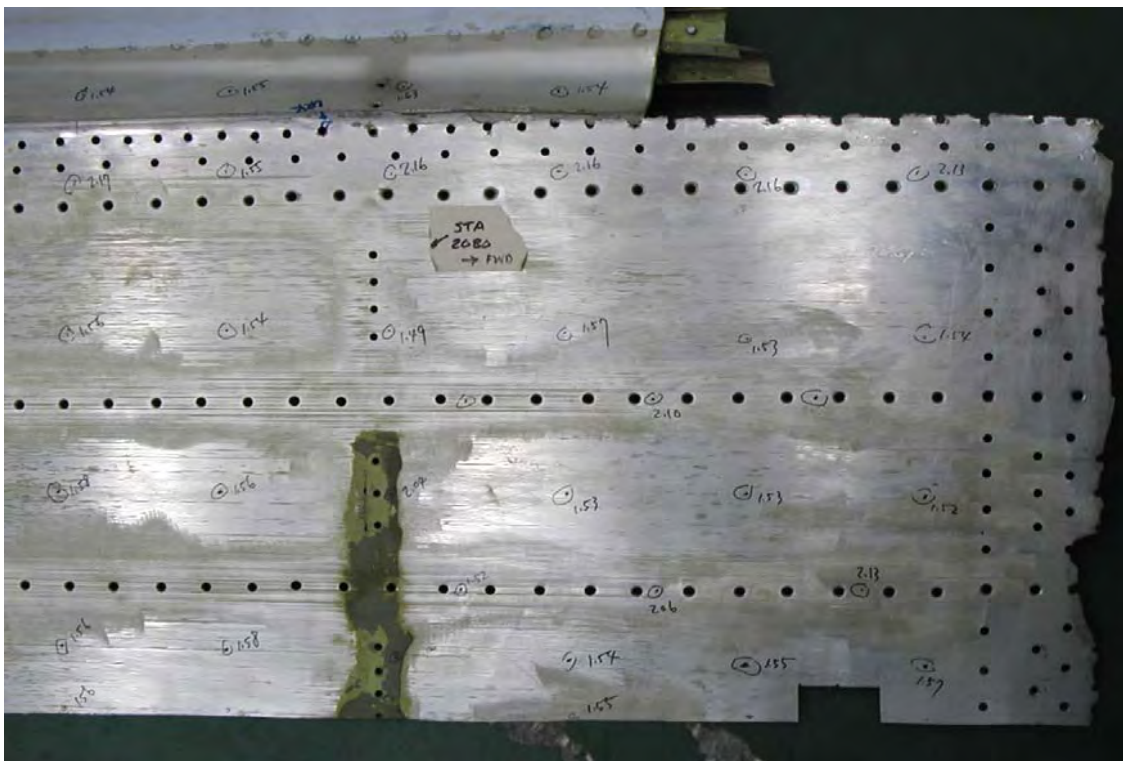

Figure 1.16-3 A close view of the repair faying surface near STA 2080

Five locations exhibiting major scratches on the repair faying surface of the skin as shown in Figure 1.16-4, were chosen for the examination of the scratch geometry and depth. The maximum scratch depth measured in each location is shown in Table 1.16-1.

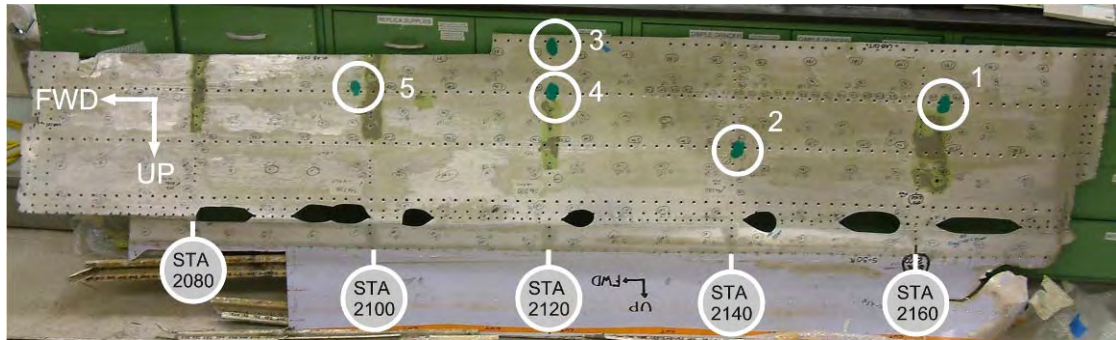

Figure 1.16-4 Locations chosen for scratch depth measurement

Table 1.16-1 Maximum scratch depth measured in chosen locations

Location	Maximum scratch depth (inch)
1	0.0072
2	0.0081
3	0.0067
4	0.0096
5	0.0066

Corrosion was noted at several shear tie locations on the skin inboard surface sometimes penetrating completely through the skin thickness. Figure 1.16-5 shows the corrosion features near STA 2100. General features of this damage and condition of the skin indicate that the corrosion was not the result of salt-water immersion after the event. Table 1.16-2 displays all the corrosion features found on item 640C1.

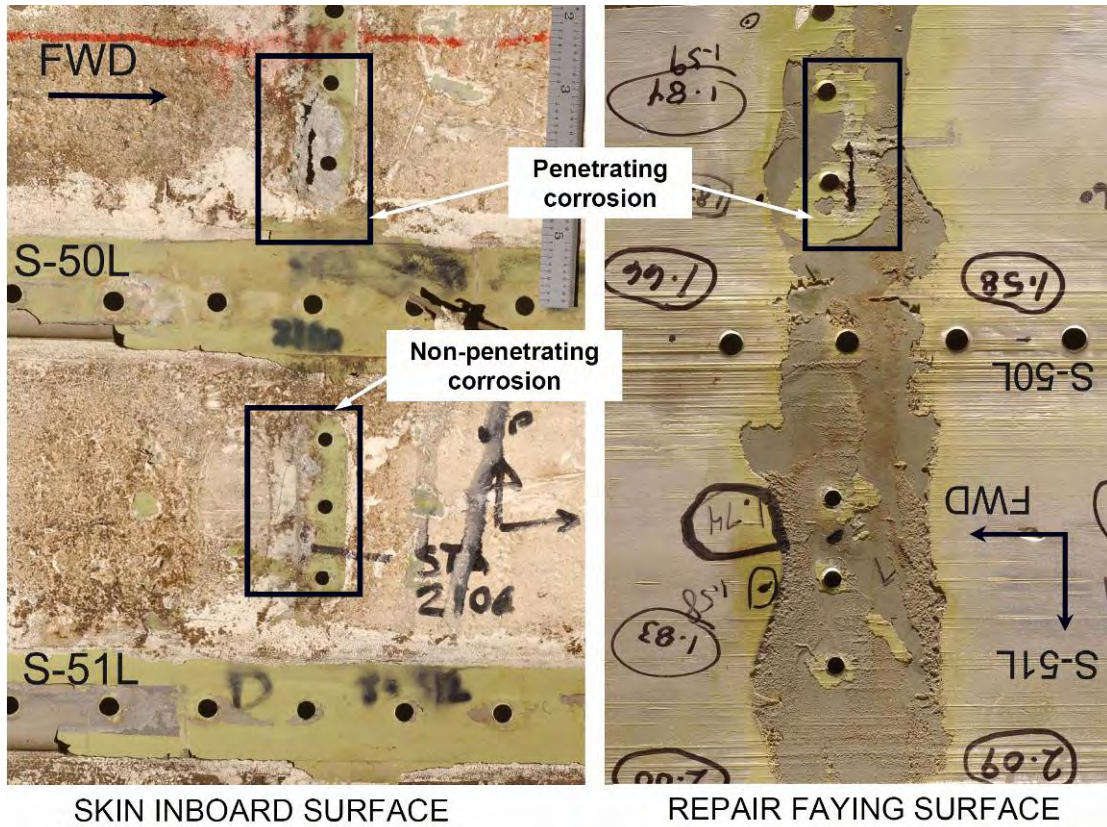

Figure 1.16-5 Skin corrosion features at STA 2100

Table 1.16-2 Item 640C1 skin inboard surface corrosion details

Station	Stringer bay	Through skin thickness	Approximate area (inch square)
2080	49L-50L	NO	0.24
2080	50L-51L	YES	0.44
2100	49L-50L	YES	1.44
2100	50L-51L	NO	0.64
2160	50L-51L	YES	2.28

In addition, spectrochemical analysis, hardness and conductivity measurements determined the materials of the skin and the doubler as 2024-T3 aluminum alloy.

### 1.16.3.2 Examination of the Repair Doubler

A light colored deposit was noted on the overhanging portion of the faying surface of the doubler above the fracture surface at S-49L as shown in Figure 1.16-6. Low power optical examination of this area revealed that this light colored deposit had a similar appearance to the light blue exterior paint applied to the doubler. Organic analysis utilizing Fourier Transform Infrared

Spectroscopy (FT-IR) of the deposit revealed that the spectra of the light colored deposit matches with the reference light blue exterior paint on the doubler (Figure 1.16-7).



Figure 1.16-6 Light colored deposit on the faying surface of the repair

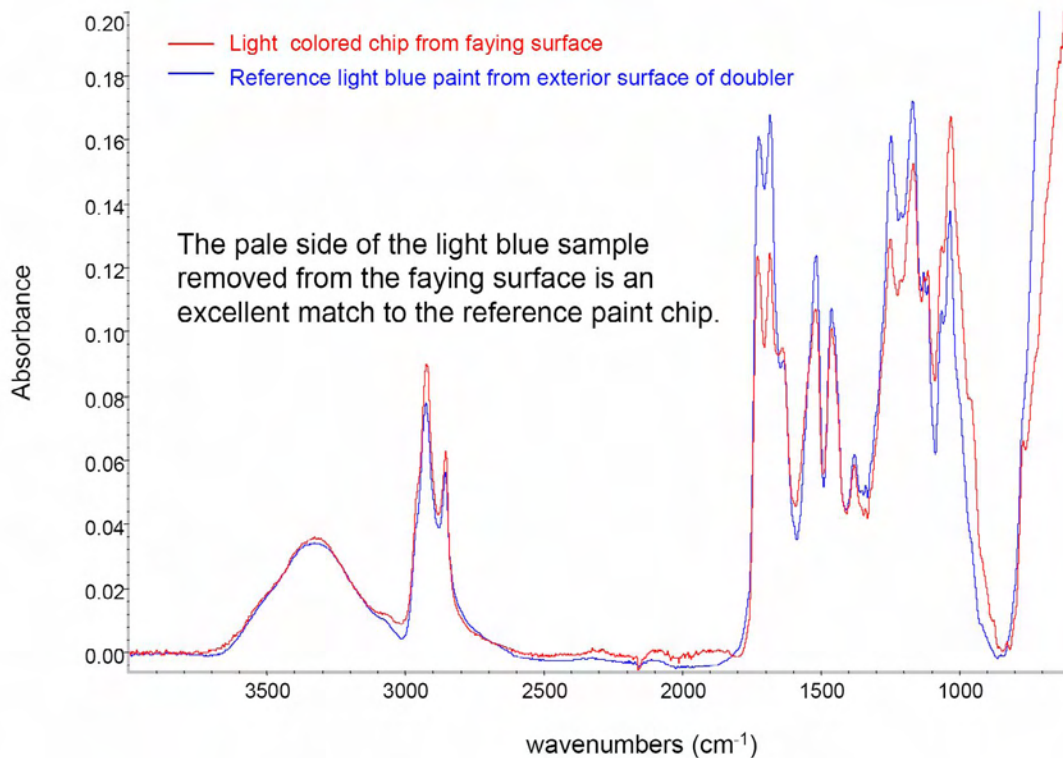

Figure 1.16-7 FT-IR analysis result

On the overhanging portion on the faying surface of the repair doubler, numerous areas exhibited signs of localized fretting above the S-49L fracture surface (Figure 1.16-8). Features of these fretting marks were described as follows:

- The fretting damage was resulted from hoop-wise movement determined by the low power optical examination and the direction of the damage.

- The fretting marks observed from STA 2061 (hole +16) to STA 2132 (hole 49) are associated with most of the rivet locations. The most significant fretting damage was present between holes 8 and 43.
- The fretting marks near hole 32 and an optically magnified photograph of the area of contact is shown in Figure 1.16-9. It shows that the area of contact exhibits many colors and some hoop-wise scratches (marked by arrows).
- Two cross-section locations were chosen to characterize the area of contact. Figures 1.16-10 and Figure 1.16-11 show the metallographic photographs through the area marked by data sampling cut #1 and data sampling cut #2 respectively. It is observed that there was some material superimposed over the grooves of the scratches.

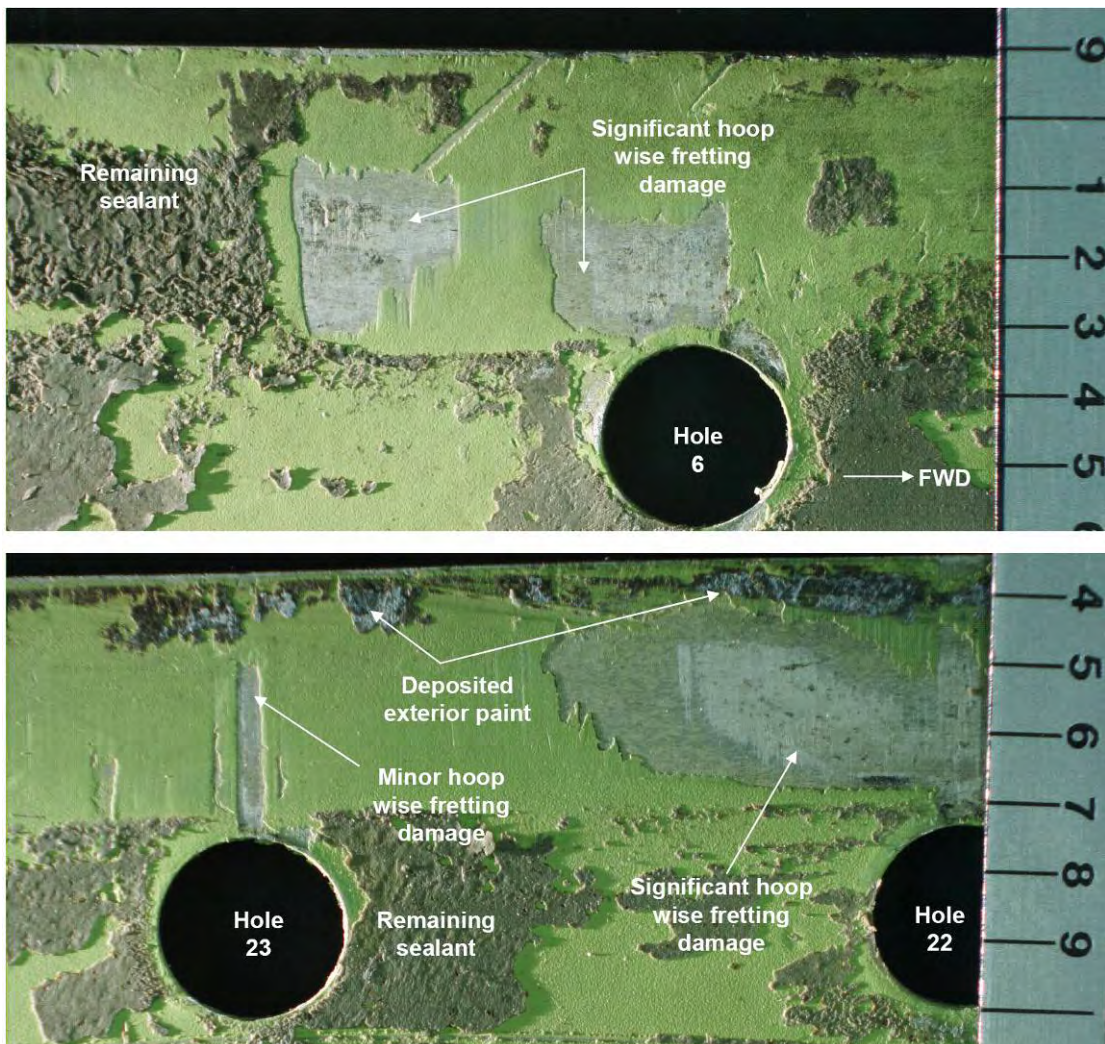

Figure 1.16-8 Fretting damage observed on faying surface of the repair doubler

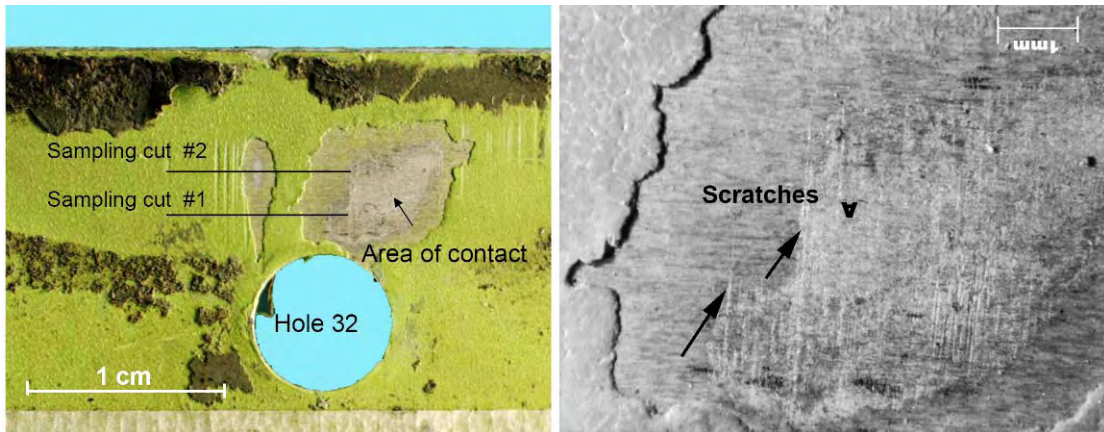

Figure 1.16-9 Area of contact near hole 32 showing the different colors (left) and scratches present (right)

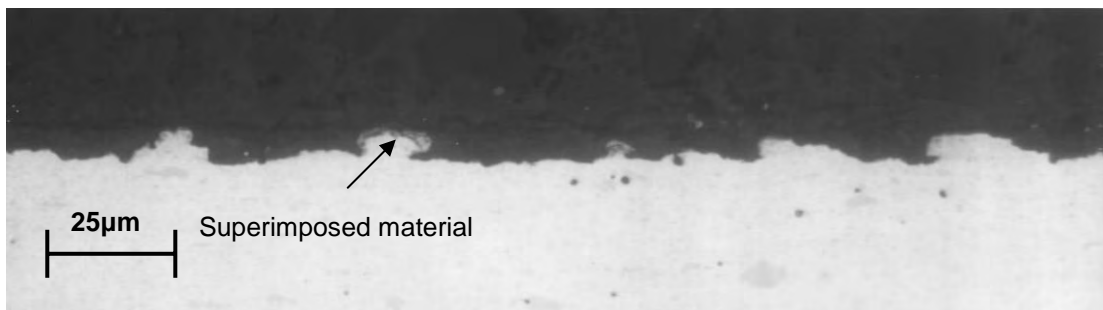

Figure 1.16-10 Metallographic photograph of the profiles marked by data sampling cut #1 in Figure 1.16-9

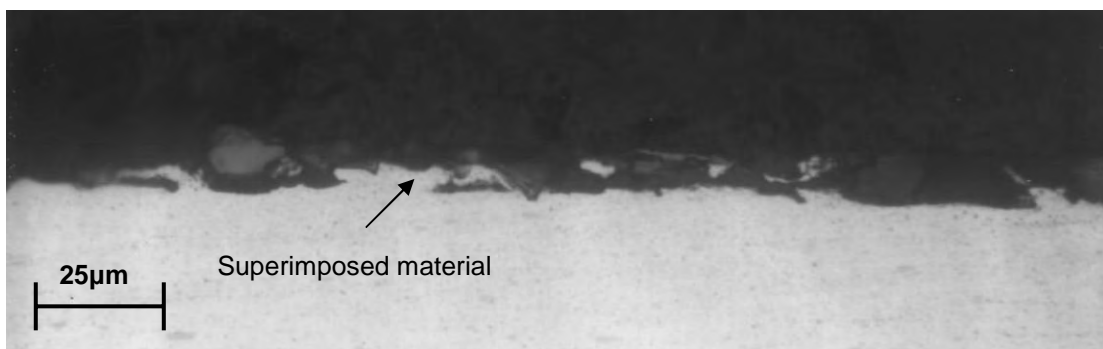

Figure 1.16-11 Metallographic photograph of the profiles marked by data sampling cut #2 in Figure 1.16-9

One additional observation described in the BMT report is the large percentage of the overdriven rivets on the repair doubler. Out of 402 rivets, 267 were found overdriven (66%), 15 were under driven (3.7%), and the rest 120 appeared to be normal (29.8%).

### 1.16.3.3 Examination of the Fracture Surfaces

The fracture surface common to the second row of rivets above S-49L were examined with a combination of visual, low power optical (up to 30X magnification), high power optical (up to 1000X), and Scanning Electron Microscopic (SEM) methods after the fracture surfaces were cleaned with a soft bristle brush and acetone. The rivets and holes along the fracture surface were numbered from +17 to 93 as shown in Figure 1.16-12 and 1.16-13 for reference. Fatigue<sup>20</sup> cracks were found in the laboratory observation.

Both CSIST and BMT confirmed most of the fatigue cracks in Table 1.16-3 except that three additional locations, holes +11 aft, 33 aft, and 34 aft, were found at the BMT. Most of the fatigue cracking area presented a flat profile in the direction of through skin thickness. A main through-thickness<sup>21</sup> fatigue crack was centered about STA 2100 from hole 10 to 25 in a length of 15.1 inches. The other smaller adjacent fatigue cracks extending from hole +14 to hole 51 can be referred to as "Multiple Site Damage (MSD)". The total cumulative length of all these fatigue cracks between hole +14 to hole 51 is 25.4 inches. Detailed distribution of all the fatigue cracks is presented in Figure 1.16-12 and 1.16-13.

Beside fatigue damage, another type of fracture feature exhibiting a pattern of overstress was observed. This overstress fracture propagated along the fracture surface parallel with S-49L forward from hole 10 and aft from hole 25.

---

<sup>20</sup> Process of progressive permanent structural change in a material subjected to repeated cyclic applications of stresses associated with operating loads.

<sup>21</sup> Through thickness cracking is defined as the crack penetrated through the entire thickness of the skin.

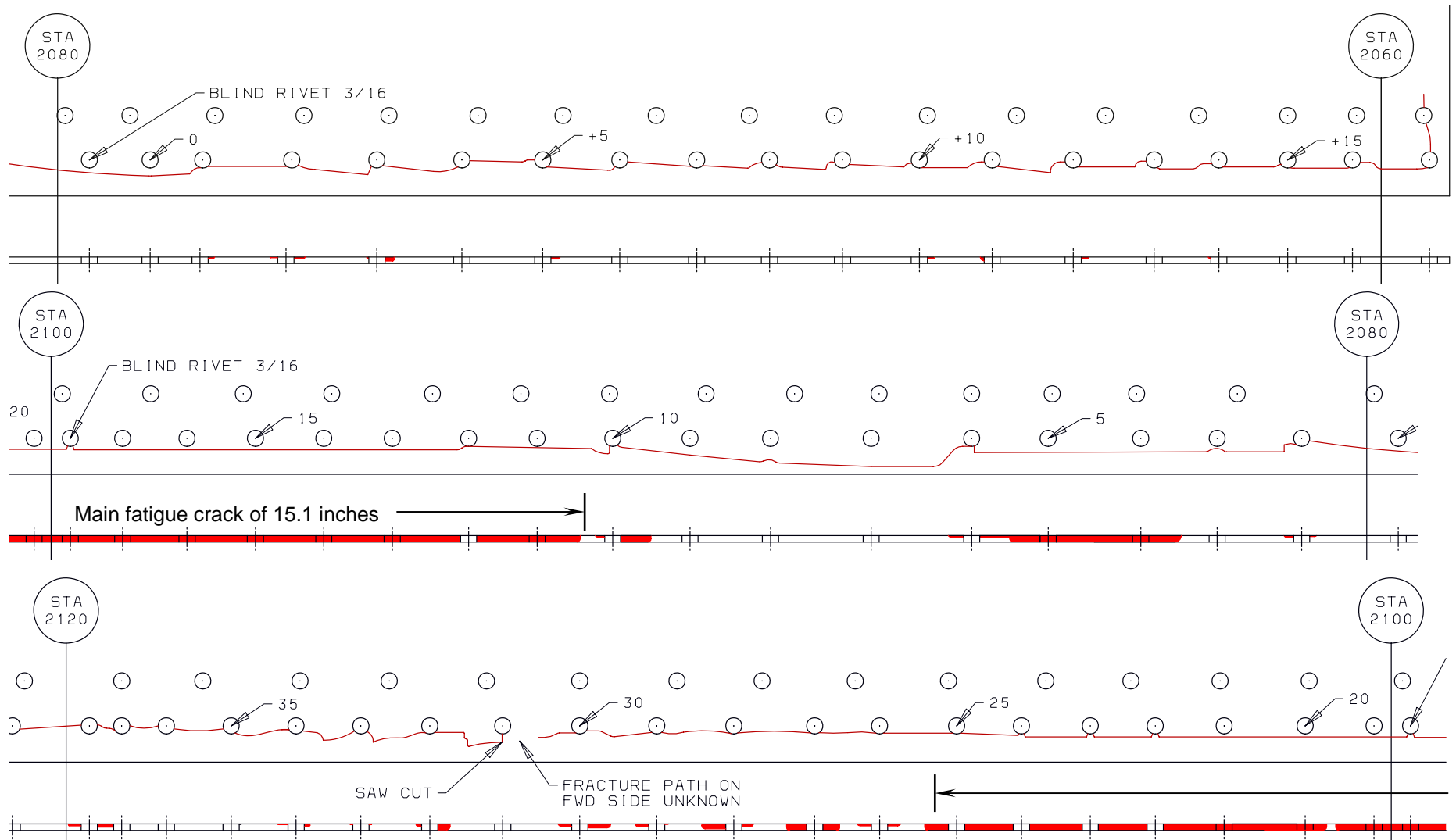

Figure 1.16-12 Distribution of the fatigue cracks (from STA 2060 to STA 2120)



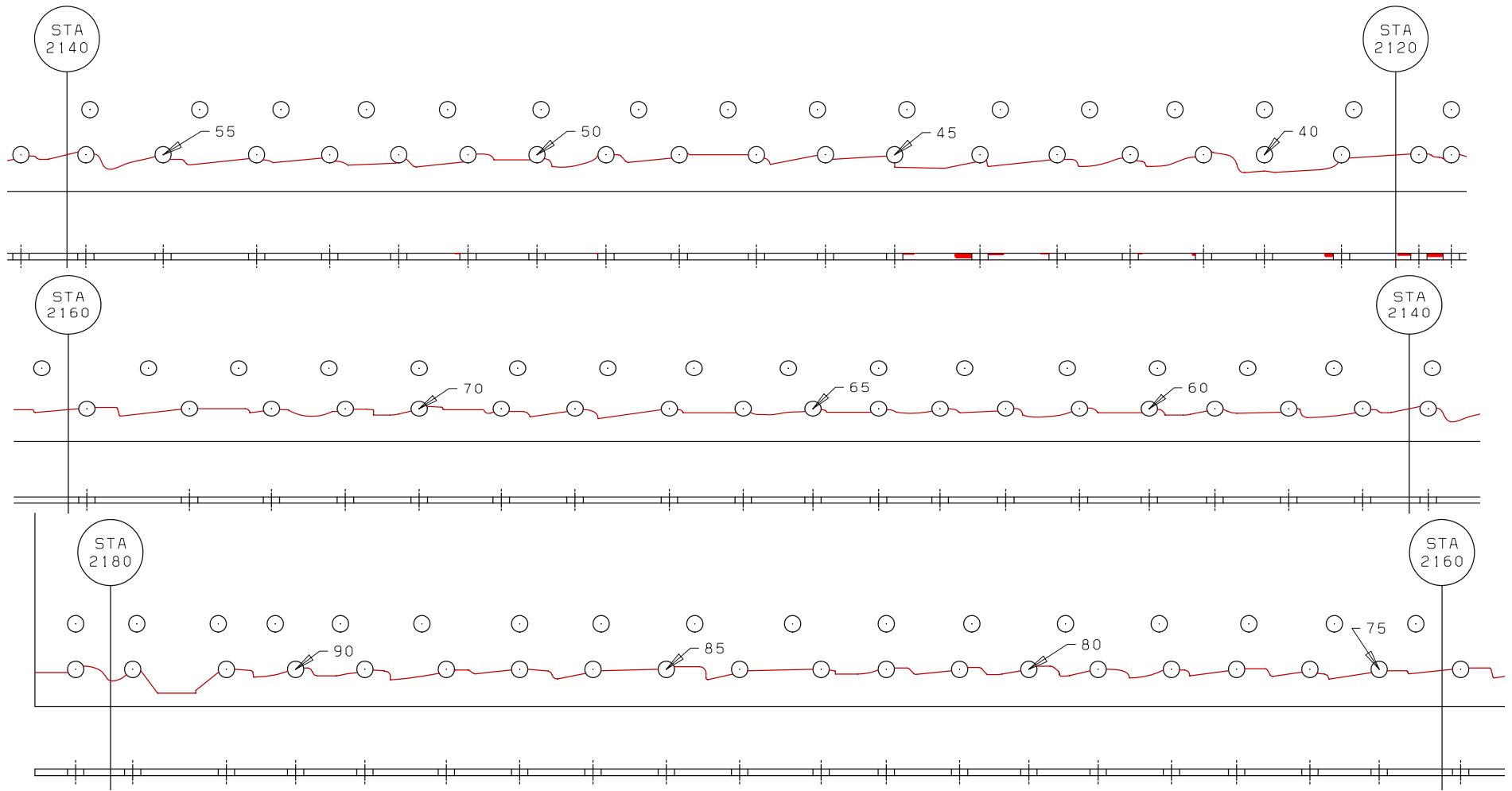

Figure 1.16-13 Distribution of the fatigue cracks (from STA 2120 to STA 2180)

Table 1.16-3 Length, depth of fatigue cracks on fracture above S-49L.

	<b>Location</b>	<b>Length of Crack (inch)</b>	<b>Depth of Crack (%)</b>
1	Aft of hole +14	0.04	20
2	Fwd of hole +12	0.12	25
3	Aft of hole +11	0.06	60
4	Fwd of hole +10	0.11	25
5	Fwd of hole +5	0.14	30
6	Fwd of hole +3	0.14	60
7	Aft of hole +3	0.03	30
8	Fwd of hole +2	0.17	25
9	Aft of hole +2	0.12	10
10	Fwd of hole 2	0.11	15
11	Aft of hole 2	0.15	30
12	Fwd of hole 4 to aft of hole 6	3.50	25-100
13	Fwd of hole 10	0.47	100
14	Aft of hole 10	0.15	25
15	Fwd of hole 11 to aft of hole 25	15.14	*95-100
16	Fwd of hole 26	0.20	30
17	Aft of hole 26	0.22	30
18	Fwd of hole 27	0.26	100
19	Aft of hole 27	0.39	100
20	Fwd of hole 28	0.18	40
21	Aft of hole 28	0.37	75
22	Fwd of hole 29	0.03	5
23	Aft of hole 29	0.21	40
24	Fwd of hole 30	0.26	60
25	Aft of hole 30	0.21	35
26	Fwd of hole 32	0.22	90
27	Aft of hole 32	0.09	40
28	Fwd of hole 33	0.04	10
29	Aft of hole 33	0.04	10
30	Fwd of hole 34	0.09	40
31	Aft of hole 34	0.17	10
32	Fwd of hole 35	0.02	5
33	Aft of hole 37 to fwd of hole 38	0.50	50-60
34	Aft of hole 38	0.09	30
35	Aft of hole 39	0.14	50
36	Fwd of hole 41	0.05	30
37	Fwd of hole 42	0.06	10
38	Aft of hole 43	0.13	10
39	Fwd of hole 44	0.23	20
40	Aft of hole 44	0.26	70
41	Fwd of hole 45	0.49	15
42	Aft of hole 49	0.02	2
43	Aft of hole 51	0.07	5

\* The crack depth at a local area forward of hole 20 was 5%.

## **1.17 Organizational and Management Information**

### **1.17.1 CAL Engineering & Maintenance Division**

The CAL Engineering & Maintenance Division (EMD) is a maintenance organization for the repair of aircraft and aircraft components approved by the CAA of the ROC. EMD is located at Chiang Kai Shek (CKS) International Airport. It is an authorized FAA and JAA repair station and is capable of performing all types of maintenance for B727, B737, B747, A300, and MD-11 aircraft. It has one two-bay hangar, one three-bay hangar for wide-body aircraft, and an engine overhaul shop. The CAL Engineering & Maintenance Division employs about 2,000 people.

#### **1.17.1.1 History of Engineering & Maintenance Division**

The EMD was founded in 1960 and located at Sung Shan Airport, Taipei Taiwan.

In 1977, the Division started in-house maintenance for B747 aircraft.

In February 1979, CAL Line Maintenance operation of the EMD moved to the CKS International Airport after the CKS started its operation in Tao-Yuan. In May 1979, the EMD started B747-200 level C checks.

In 1980, the entire EMD had 9 departments, including Aircraft Maintenance, Shop Maintenance, Customer Service, Chief Engineering, Quality Assurance, Administration, Accounting, and Security. It had total of 1,250 employees. The Division maintained 15 CAL airplanes, including one B747-100, two B747-200s, one B747-SP, four B707s, three B737-200s, and four B727-100s. In the same year, the EMD contracted with United Airlines and adopted UA's Maintenance Program for B747-200 level D repair. In addition, the EMD planned to implement B747 fuselage, engine and component maintenance capability.

In 1982, the entire EMD relocated its facilities from Sung Shan airport to the CKS International Airport.

In 1983, the EMD completed planning and the job card system for the 4th stage inspection and maintenance for B747 aircraft.

In 1985, the EMD established D check capability and capacity on B747 type

aircraft.

In 1986, the EMD established D check capability and capacity for B747 cargo planes and established overhaul capability and capacity for B747 and A-300 aircraft.

In 1987, the EMD established the capability for advanced composite materials and introduced a Quality Audit System to ensure inspection quality.

In June 1991, the EMD restructured from one Division to two Divisions: the Maintenance Division and the Technical & Supply Division.

In 1993, the EMD applied for a JAA licensing and technical review system. The Quality Assurance Department became one of the independent departments with 85 staff reporting directly to the VP Maintenance. The Quality Assurance Department had 5 sections including, Shop Inspection, Aircraft Inspection, Quality procedures/record/analysis, Equipment and Supply Inspection and Non-destructive Inspection.

In 1995, the Tzu-Chiang (Flight Safety enhancement) Project began, the EMD reorganized from two Divisions back to one Division with 13 different Departments, Centers, and Offices. In the new Division, both Maintenance Division and Quality Assurance Department reported to the VP Maintenance. The Quality Assurance Department was responsible for ISO9000 application. In 1996, the EMD completed ISO-9002. It obtained JAR145 Repair Station license (JAA) and received certificates from the National Calibration Laboratory of the Republic of China.

In 1998, CAL completed the reorganization of its Maintenance Division. The internal technical personnel certification & authorization system was established

In 1999, the Tzu-Chiang Project was completed. CAL incorporated a qualification system that meets JAR-66 and FAR-66 requirements for maintenance quality. The Maintenance Management training course was established. The Quality Assurance Department completed an internal certification and authorization process for CAL personnel.

In 2000, Shop Maintenance & Engine Maintenance Department started the Quality Check (QC) system with QC inspectors.

### **1.17.1.2 Structure of Engineering & Maintenance Division**

The EMD is one of the five Divisions of China Airlines Limited. The other four Divisions are Marketing, Service, Administration, and Flight Operations.

The EMD is headed by a Vice President (VP) who reports directly to the Senior Vice President of Engineering & Maintenance. The Division is divided into several departments and sections as outlined in the Quality Manual. According to the CAL Quality Manual, the Vice President of Engineering and Maintenance Division has been delegated full authorities and responsibilities for the CAL EMD.

The departments within the EMD are Aircraft Maintenance, Shop Maintenance, Business & Support, and Quality Assurance. A General Manager heads the Quality Assurance Department. Assistant Vice Presidents manage the other three departments.

### **1.17.1.3 Aircraft Maintenance**

The Aircraft Maintenance (MX) has four departments: Line Maintenance, Base Maintenance, Equipment & Facility, and Customer Service. The Assistant VP for Aircraft Maintenance is delegated as a management representative of the Division and reports to the VP EMD.

The Aircraft Maintenance establishes and publishes the maintenance procedures for use within the organizations and is responsible to achieve good maintenance practices and compliance with Airworthiness Authorities requirements. The Aircraft Maintenance ensures that work is accomplished to the highest standards of airworthiness and workmanship and all maintenance is correctly certified and that records of maintenance carried out are retained safely and securely for the statutory period.

#### **1.17.1.3.1 Base Maintenance Department**

The Base Maintenance Department (MB) is responsible for all organizational, technical, and personnel aspects of heavy maintenance, structural repair, electric, radio, instrument (ERI) maintenance, cabin maintenance and aircraft components. The Base Maintenance Department handles all B, C, D Checks, heavy maintenance, and all the maintenance that is beyond the capabilities of

the Line Maintenance Department. The Base Maintenance Department is divided into 6 sections: Production Planning Section, Maintenance Production Center, Structural Maintenance Section, Interior Maintenance Section, Hanger APG Maintenance Section, and Hanger ERI Maintenance Section. The General Manager of the Base Maintenance Department stated that in these 6 sections, Production Planning Section is in charge of heavy maintenance schedule planning. The Maintenance Production Center is in charge of monitoring and controlling the maintenance flow and status. The rest of the sections are the actual maintenance production sections.

#### **1.17.1.4 Shop Maintenance**

The Shop Maintenance (MY) is managed by an Assistant VP and has four departments: System Engineering, Technical Training, Shop Maintenance, and Engine Maintenance Departments. The Assistant VP for Shop Maintenance stated that the System Engineering Department was in charge of converting all the Maintenance Planning Data (MPD) to the company Aircraft Maintenance Program (AMP) for implementation, issuing Engineering Orders (EO), fleet planning, technical support, and project research. The Technical Training Department provides regulations, human factors, language, and aircraft type training to Divisional personnel. The Engine Maintenance Department is in charge of “off-wing” engine maintenance. The Shop Maintenance Department is in charge of aircraft component overhaul and parts maintenance.

The Assistant VP for Shop Maintenance stated that the Quality Assurance Department audits the Engine Maintenance and the Shop Maintenance Departments on both scheduled and unscheduled basis. During the maintenance process, some items needed to be double-checked by the quality inspectors while the maintenance is in progress. The Quality Assurance Department also spot-checks the process, procedures, and job cards during maintenance. Within the Shop Maintenance, managers of different shops will crosscheck each shop for self-audit. Within every six-month period, all 13 departments in the EMD will crosscheck each other in accordance with the self-audit checklist.

##### **1.17.1.4.1 System Engineering Department**

The System Engineering Department (ME) establishes and maintains the

Aircraft Maintenance Program (AMP) of CAL, evaluates and implements Airworthiness Directives and other regulatory requirements for aircraft and equipment, evaluates and implements Service Bulletins and other equivalent O.E.M documents, and performs Reliability Control in accordance with the current CAL Reliability Control Program and compliance with the rules laid down in Reliability Control Program.

The System Engineering Department was divided into five sections: Technical Information, Structures, Power plants, Systems, and Avionics. The Chief Engineer of the System Engineering Department stated that in addition to converting the MPD into the company AMP, the System Engineering Department received and reviewed ADs and SBs, converted them into company EOs and issued the EOs to the respective maintenance departments for implementation. Some special programs, such as RAP, CPCP, and aging aircraft issues, are evaluated by the System Engineering Department.

#### **1.17.1.4.2 Shop Maintenance Department**

The Shop Maintenance Department (MD) is engaged in the maintenance, repair and overhaul of aircraft components as well as inspection, repair, and calibration of test equipment and precision measurement equipment. The department is responsible for the certification of the continuing airworthiness inspections and airworthiness of aircraft/issue of Certificates of release to service. There are seven sections in the Shop Maintenance Department: Production Control, PME, Avionics, Hydraulics, Instruments, and Wheel & Brake. The NDI (Non-Destructive-Inspection) Shop was originally under the Quality Assurance Department but is now under the Wheel & Brake Shop.

##### **The NDI Shop**

The NDI Shop is responsible for the non-destructive testing of aircraft and aircraft components. The NDI engineer stated that there are currently 5 NDI methods in use in the shop: Magnetic Testing (MT); Liquid Penetration Inspection (PT); Eddy Current Inspection (ET); Ultrasonic Testing (UT); and Radiographic Testing (RT).

The NDI engineer stated that when the Engineering Department issued job cards, if there is a requirement for NDI, the method or technique would be specified on the job card. If the Engineering Department can not determine the

appropriate NDI method for an inspection, the engineers would consult the NDI Shop.

Currently, the most widely used NDI method (except Visual Inspection) in the NDI Shop is high frequency Eddy Current Inspection.

### **1.17.1.5 Quality Assurance Department**

The Quality Assurance Department (MI) is responsible for quality regulations and audits for the EMD. It ensures that all work performed on the aircraft, engines, and associated components are in compliance with applicable requirements of relevant Airworthiness Authorities' prescribed procedures, technical specification, current engineering and aviation standards, and sound industry practices. The General Manager for Quality Assurance Department reported to the Vice President and, according to CAL Quality Manual, has the following responsibilities:

- *Establish an independent quality assurance system in consultation with supervisory authorities and the Vice President and coordinating and proposing measures to assure and promote quality;*
- *Establish, implement, and monitor approved company policies and procedures for the daily operations of the Quality Assurance Department;*
- *Implement quality audit programs and procedures;*
- *Implement departmental coordination to ensure compliance with the JAA, FAA and the CAA Requirements for maintenance activities on aircraft, power plant and components;*
- *Ensure mandatory modification programs and AD/alert service bulletins are incorporated or complied with within the statutory time limits;*
- *Approve the technical personnel qualification procedures and issuance of approval certificates to properly qualified maintenance staff to carry out work in accordance with the terms of approval certificates;*
- *Responsible for the inspection system; and*
- *Report to CAA when detecting any suspected unapproved parts.*



According to the CAL Reliability Control Program Manual, the purpose of quality assurance is to ensure the continuing airworthiness of all airplanes, including engines and components, and comply with both CAA and FAA requirements. The Reliability Control Program is a closed loop process, managed and governed by the Reliability Control Board (RCB) to ensure a safe, reliable and economical fleet operation.

There are four sections in the Department: Audit, Regulation, Shop Inspection, and Aircraft Inspection.

The Regulation Section is responsible for development of a quality assurance system acceptable to all regulatory authorities concerned. It is responsible for coordinating with related regulatory authorities and submitting reports to relevant authorities, manufacturers and customers of any service difficulties encountered by CAL fleets.

The Audit Section is responsible of developing the quality audit system. It monitors the quality audit system and evaluates the inspection feedback reports of the Quality Inspection Function.

The Aircraft Inspection Section carries out Quality Control Sampling Checks on all overnight, scheduled maintenance, defect rectification, and overhaul maintenance. It performs on-site inspections of Required Inspection Item (RII) for aircraft maintenance activities. In addition, it provides release to service of aircraft that have undergone regular checks, such as A, B, C, and D checks.

The Shop Inspection Section conducts Quality Control Sampling Checks on testing, repair, modification or overhaul for shop maintenance and engine maintenance activities.

On October 16 2003, the Quality Assurance Department was separated from the EMD and renamed as Engineering & Maintenance Quality Management Office. The Vice President of the Office reports directly to the Senior Vice President of Engineering & Maintenance.

#### **1.17.1.5.1 Inspection Procedure**

A technician qualified by CAL, who performs a specified defect corrective action, certifies that he/she has accomplished the defect corrective action via inspection

and that the corrective action was properly carried out in accordance with the approved maintenance instructions and that serviceability was validated by a required test. After the completion of the task, the qualified technician shall issue a release for service.

If an RII is needed, a qualified inspector will conduct an on-site inspection. The scope of the duplicate inspection covers the following:

- *Document (form, content, revision status)*
- *Tools and equipment (suitability, permissibility, condition)*
- *Material (suitability, permissibility, condition)*
- *Method (suitability, permissibility)*
- *Qualification of the person carrying out the first inspection (formal, actual)*
- *Result (corresponding with the requirements)*

According to the CAL Quality Manual, If an airframe, engine or component has been involved in an accident or was damaged, the inspection is not limited to the areas of the obvious damage or deterioration but shall include a thorough inspection for hidden damage in areas adjacent to the damaged area and/or in the case of deterioration, a thorough review of all similar materials or equipment in a given system or structural area. The scope of this inspection is governed by the type of unit involved with special consideration given according to the previous operating history, together with malfunction or defect reports, and SB and AD notes applicable to the unit involved. The inspector is responsible for listing all discrepancies noted on the work order, prior to release for return to the service.

Prior to the approval for return to service, regardless of the method used for such approval, the authorized staff will review the work package, as identified by the work order, to ensure that all work has been inspected as required.

This approval will be determined after the completion of progressive inspections by authorized staff. All inspection records should be kept for at least two years.

#### **1.17.1.6 CAL Maintenance and Inspection Procedures in 1980**

The Safety Council was unable to locate any documents regarding maintenance and inspection procedures at CAL in 1980. Several CAL senior managers stated

that the work and inspection procedures, regarding the removal of the scratched skin areas, were quite different 22 years ago. Basically, the technicians would follow the manual. When there was no SRM instruction available, the repair would be based on the manufacturer's instructions or engineer's experience. There was a QC system at the time, however, it's very difficult to trace the QC procedures since the old QC procedures were discarded after revision.

### **1.17.2 Boeing Field Service Representative**

In 2002, Boeing had three Field Service Representatives (FSRs) at China Airlines to provide technical support for Boeing's products. The Boeing FSR office is located at CAL CKS hanger.

According to Boeing Commercial Field Service Procedure Manual, the FSRs responsibilities are:

- *Assigned to operators as technical advisers and serve as the single point-of-contact for Boeing support issues in the field;*
- *Apply their understanding of the operators' business environments to reduce cost of ownership, increase safety, and improve operational efficiency;*
- *Work closely with operator teams to solve a broad range of airline management concerns; and*
- *Understand all Boeing CAS offerings and use their knowledge and technical expertise to advise operators in the selection and use of Boeing products and services.*

In addition to the requirement for data collection and reactive reporting, the FSR is expected to be more involved in predictive and proactive problem solving.

The Boeing Commercial Field Service Procedure Manual also stated the limitations of the FSRs. The FSRs may advise and recommend, with the understanding that final decisions are entirely the responsibility of the operator. The FSRs must be particularly careful to avoid being placed in a role of approving technical work or modifications to operator aircraft. The FSRs work with the operator only in an advisory capacity.

The Boeing Field Service Manager for CAL stated that after an aircraft is delivered to an operator, Boeing FSRs provide the technical support to maintain

the aircraft. Usually the Structure Repair Manual, Wire Diagram Manual, and other maintenance manuals provide the operators with information to conduct the standard repairs. The operator will conduct the repair if the manual covers the procedures of the repair. If the problem goes beyond the limitation in the manual, then Boeing FSRs may be requested to get involved.

The Boeing Field Service Manager for CAL stated that only when the manual covers the problem, the FSRs could make a suggestion to the operators regarding how to solve the problem. If the problem is beyond the manual, then the FSRs can not design nor approve the repair regardless of their background. The FSRs will send a technical message to Boeing, describe the problem and get the repair permit from the home office. When a person becomes a FSR, no matter what his/her previous background was, he/she has no authority to do anything on site. The FSRs act as the liaison personnel between the operator and Boeing Head Office.

#### **1.17.2.1 Communication Procedures**

Facsimiles, telephone, or e-mail may all be used for communication between Boeing and external customers. However, formal communication between Boeing and external customers must use BOECOM for information exchange. According to Boeing Commercial Field Service Procedure Manual, BOECOM is a three-part computing system that supports formal communication between the Boeing Home office, the customer, and Field Service remote offices.

When Boeing FSRs receive a request from CAL engineers, such as if the engineer could not find the repair in the standard repair manual, the FSRs would suggest the engineer do certain research. If the repair relates to structural repairs, the CAL engineers have to complete sketches and other information, Boeing FSRs will not do so for the operator. The engineers will provide Boeing FSRs with the information and the FSRs will send the information to Boeing Home office. After receiving the reply, the FSRs will review the reply for appropriateness and completeness and distribute the information to related operator personnel.

#### **1.17.2.2 RAP Guidelines and Consultation**

As a response to a query regarding the FSRs' involvement with the RAP, the

Field Service Manager stated that the RAP document is an industry effort. By following the FAA's instructions, Boeing provides recommendations to operators on how to conduct the repair assessment.

The Field Service Manager stated that the RAP is a huge program and has been developed over a long period. Since RAP is not fully implemented yet, CAL structural engineers consulted Boeing FSRs regarding the content of the RAP, as some of the program content is vague to non-English speaking persons. The RAP is a guideline, which provides operators guidance to develop their own programs. Operators have to raise official requests for Boeing's consultation, but the manufacturer has no authority to approve an operator's program.

### **1.17.2.3 Boeing Field Service Representative in 1980**

According to a document issued by Boeing in September 1980 regarding the duty of Boeing FSR:

*The customer Field Service Representative is responsible for providing assistance to the customer in the resolution of problems that affect the operation of Boeing airplanes. Such problems are expected that the areas such as training, spare parts availability, ground support equipment, etc. In the performance of his assignment, he will:*

- 1. Advise customer personnel in matters pertaining to the functional testing, maintenance and repair of aircraft, components and equipment manufactured and/or designed by Boeing;*
- 2. Assist customer personnel in solving problems associated with customer or vendor-furnished hardware installed on Boeing airplanes;*
- 3. Assist customer personnel in procuring, through proper channels, adequate spare parts for maintenance of their airplanes and related equipment;*
- 4. Coordinate airline recommended modifications or procedural changes with home office airline support groups;*
- 5. Investigate and report technical problems experienced with Boeing designed aircraft. Coordinate with the home office*

*Airline Support Groups in analyzing technical and operational problems to determine what maintenance procedures, operational procedures or design changes may be required to correct the problem. Certain actions such as a maintenance or operational procedure change may be require for an interim period until a design change can be effected;*

6. *Report ideas and suggestions for improvement of maintenance practices for Boeing aircraft; .....*
7. *Report periodically those problems, which are foremost in the minds of airline upper management. Such problems should not be limited to operations or maintenance difficulties. Any items, which could significantly impact the utilization of Boeing aircraft, should be reported.*

#### **1.17.2.3.1 Boeing FSR Involved with the 1980 Tail Strike**

In 1980, Boeing had one FSR at the CAL. The following is the summary of the interview notes of the Boeing FSR who had involved with the tail strike in 1980.

The FSR stated that the airplane was ferried back to Taipei after the tail strike occurrence and had a temporary repair. At that time, the FSR and the CAL Chief engineer determined that the damaged skin needed to be replaced; the permanent repair should be conducted per SRM. The engineering instruction at that time was requesting the CAL to complete the permanent repair by skin replacement or per SRM within six months.

The FSR stated that he had read the engineering memorandum and agreed with it. The content of the memorandum was describing the cause of the damage, the location of the damage, the necessity of the temporary repair, and the methodology of the permanent repair shall be skin panel replacement or per SRM. The detailed description of the repair methodology did not need to be sent to Boeing.

The FSR stated that according to SRM, the permanent repair should cut out the damaged skin, add filler, and place a doubler to cover the damaged area. The doubler must oversize the filler by at least three rows of rivets. If the stringer was damaged, it should be fixed per SRM as well.

The FSR stated that usually the temporary repair was to place an external

doubler outside the damaged area (did not cut out the damaged area). He did not know whether the CAL had conducted the permanent repair or not because he did not actually see the repair. The CAL did not inform him when the repair was carried out. The FSR stated that the CAL had QC system to monitor the maintenance operations. CAL did not need a Boeing FSR when it carried out the repair operation. The CAL did not report to Boeing when the permanent repair was completed. The CAL maintenance was reporting to the QC. There was no reason for CAL reporting to the Boeing FSR.

The FSR stated that the FSR was not running the business for CAL; therefore, CAL did not have the responsibility to report to FSR. The FSR was to provide technical assistance to the airline on maintenance and operation on Boeing's aircraft as an advisor.

The FSR shall report to Boeing when an aircraft has an occurrence. If Boeing agreed with the proposed repair plan, Boeing did not need to response. The FSR stated that when he reported how the CAL planned to handle the damage of the tail strike to Boeing, if Boeing had any comment (for example, if Boeing think 6 months is too long), Boeing would raise the opinion. However, Boeing had no comment at that time.

The FSR stated that the CAL might not inform FSR about the permanent repair. If there were problems encountered during the repair, the CAL would consult FSR for the technical issues. Otherwise, the CAL would not contact the FSR. The FSR believed that the permanent repair should not have any problem. If there were a problem, the CAL would contact the FSR. The repair was not a complicated repair. If the repair was conducted per SRM, there was no need to contact FSR. The CAL did not contact the FSR for the repair at that time.

### **1.17.3 The Civil Aeronautics Administration, ROC**

#### **1.17.3.1 CAA Evolution**

In 1919, an aviation authority was established to handle aviation affairs in ROC. Having moved to Taiwan with the government in 1949, CAA amended its organic rules to meet operational demands in 1972. Following the government's open sky policy in 1987, in order to cope with the flourishing aviation industry, another amendment of the organic rules was drafted for promulgation in June 1998.

### **1.17.3.2 CAA Organization**

Today, the CAA of ROC belongs to the Ministry of Transportation and Communication (MOTC). The Director General, aided by two Deputy Directors General and a Secretary General, head the CAA. Internal units comprise seven Divisions of Planning, Legal & International Affairs, Air Transport, Flight Standards, Air Traffic Services, Aerodrome, Air Navigation Facilities and the Logistics, along with the five Offices of Information, Secretariat, Accounting, Personnel and Government Ethics.

At the present, CAA and affiliated organizations together have more than 2,400 employees.

### **1.17.3.3 CAA Oversight**

Based on the stipulations of the Civil Aviation Law and pertinent regulations, CAA is the agency responsible for administering and assisting the civil aviation industry. Its inspection functions can be classified into two categories, namely flight operations and airworthiness, aimed at ensuring that flight crews are qualified, trained judiciously dispatched, and air carriers operate in full compliance with the regulations and conduct periodic maintenance and repair to remain airworthy. Air operator will be notified of any deficiencies found by inspectors during inspections and they are subject to follow-up checks, until corrective actions have been made.

### **1.17.3.4 The Inspection System of CAA**

From 1995 to 1997, the CAA restructured its Aviation Safety Inspection System in order to meet ICAO standards. The purpose of the restructure was to establish the required regulations, manpower and training standards for the aviation safety inspectors.

Under the organization of CAA, the Flight Standards Division conducts operations and airworthiness inspections in accordance with the Civil Aviation Law to sustain the safety of aviation operations. In addition, the division is in charge of the airman certification testing, certification and issuance of certificate, airman registration, and supervision of the civil aviation training school. It also plans and programs its flight safety related policy and updates CAA regulation as well to continually meet ICAO standards.



Operations/airworthiness inspections are scheduled on an annual basis to ensure airlines continue to meet certification standards and regulatory requirements. Each inspection has specific written procedures for accomplishment for ramp, spot, and records inspections, etc.

Aircraft maintenance programs are intended to maintain aircraft in an airworthy condition. In accordance with Aircraft Flight Operation Regulation and Regulation for Aircraft Airworthiness Certification, the CAA approves the airlines' continuing airworthiness maintenance programs. According to the regulations, each airline has to conduct maintenance of its aircraft in accordance with the approved maintenance programs. CAA oversight includes scheduled and unscheduled spot inspections based on the approved maintenance programs. Appropriate enforcement actions are taken by the CAA for any non-compliance items found during the inspection.

Under the Flight Standards Division, the Airworthiness Branch was responsible for regulating aircraft airworthiness matters.

### **1.17.3.5 Major Tasks of the Airworthiness Branch**

Before 1996, the airworthiness inspection was conducted in accordance with Regulations and Procedures contained in CAA Flight Operation Safety Inspection Procedures, 07-01B. The major inspection task covered the following:

- *Airworthiness Inspection of Aircraft: It was conducted in accordance with the maintenance inspection record form during application or annual renewal of Certificate of Airworthiness;*
- *Inspection of base maintenance of aircraft: It was conducted according to the checklists during overhaul, major repair, alteration or C check and above;*
- *Aircraft Ramp Inspection: It was conducted by random inspection of the maintenance of aircraft operated at various airports; and*
- *Inspection of Repair Station Certification: It was conducted in accordance with the requirements of Regulation for Certification of Repair Station of Civil Aircraft.*

After the 1996 International Aviation Safety Assessment (IASA), the CAA has prepared the airworthiness inspector's handbook, by referring to the FAA inspection standards, to serve as a reference for CAA inspectors. The specific

job task includes:

*Technical Administration*

- *Evaluate a malfunction or discrepancy report*
- *Provide Technical Assistance*
- *Accident Investigations*
- *Incident Investigations*
- *Compliance Investigations*
- *Non-compliance Investigations*

*Certification /Approval*

- *Certification of Operation Specifications of Air Operation Certificate for civil aviation transportation*
- *Approve Aircraft Maintenance Program of CAA registered Aircraft*
- *Approve Air Carrier's Aircraft/Engine monitoring Programs*
- *Certificate Airframe and/or Power-plant Mechanics*
- *Designate/Renew Mechanic Examiners*
- *Approve Category II and III Approach Maintenance Programs*
- *Approve ETOPS Program*
- *Approve RVSM Program*
- *Approve Air Carrier's Maintenance authorizations*
- *Approve Weight and Balance Control Program*
- *Approve Minimum Equipment List (MEL)*
- *Approve Manuals/Revisions*
- *Approve Technical Documents*
- *Approve Applications for Deviation*
- *Approve Continuing Analysis and Surveillance Programs*
- *Approve Maintenance Training Programs*
- *Conduct Aircraft Proving Flight Tests*
- *Approve Emergency Evacuation/Ditching Procedures*
- *Evaluate Aircraft Lease Agreements*
- *Ferry Flight Authorization*
- *Certificate of Airworthiness Renewal*

### *Surveillance / Audit*

- *Inspect Operator's Main Base*
- *Sub-Base Inspection*
- *Line Station Inspection*
- *Shop inspection*
- *Manual Inspections*
- *Inspect Operator's Contract maintenance Facility*
- *Inspect Refueling Facility*
- *Conduct Ramp Inspections*
- *Spot Inspections*
- *Training Programs*
- *Weight and Balance Inspections*
- *Structural Inspections*
- *Conduct Cockpit En-route Inspections*
- *AD Compliance*
- *Special Tools and Test Equipment Inspections*
- *Maintenance Inspection Programs*
- *MEL/MMEL Inspections*
- *Mechanic/Inspector Surveillance*
- *Inspector Records*
- *Log Book Inspections*
- *Contract Maintenance Facility Inspection*
- *Self Audit Program Inspection*
- *Reliability Program Inspection*
- *Major Repairs and Alteration Inspections*
- *Ground Deicing/Anti-icing Inspections*
- *Short Term Escalation Inspection*
- *Service Difficulty Reporting System*
- *Engine Test Cell Inspection*
- *Operator In-depth Inspections*

### **1.17.3.6 CAA Inspection System from 1979 to Present**

The Safety Council was not able to obtain CAA oversight activity records before 1996. According to CAA policy requirements, such inspection records are retained for two years. All of the inspectors working in the 1980 time frame are now retired.

The CAA stated that the aviation regulations at the time (from 1979 to 1996) were not as complete as they are now and that the CAA aviation safety inspection system was not as well established as the present system. There was no specific inspection system or inspection plan at the CAA in 1980. Furthermore, the inspectors had no handbook for inspection guidelines and no inspector training to carry out flight safety inspections.

Officially, the FAA and CAA have no obligations toward each other. The CAA stated that the FAA provides all ADs to the state of aircraft registry. The Aircraft Certification Institute consigned by CAA shall directly adopt them as ROC ADs. Article 6 of the Regulation for Aircraft Airworthiness Certification requires the operator to comply with all ADs issued by the State of Manufacturer and those by the ROC.

Cooperation between the FAA and CAA takes place through various joint agreements. In 1996, the FAA conducted an International Aviation Safety Assessment (IASA) of the CAA. The IASA examines the ability of a State's regulatory and safety oversight organization (CAA) to meet its international obligations contained in ICAO SARPs (Standards and Recommended Practices). The ROC CAA was rated as Category II, which basically means that the CAA was deficient in its ability to comply with ICAO SARPs. As a result of the 1996 IASA, the CAA developed an inspection program meeting ICAO and FAA requirements, recruited new inspectors, set up inspector training programs, and established inspector handbooks. The FAA rated the CAA as Category I in 1997.

Before 1996, there were no dedicated instructors to train CAA inspectors. The CAA sent different inspectors to attend training courses at the FAA Training Center in Oklahoma, USA. After the IASA Assessment, the CAA hired several professionals retired from FAA to serve as consultants to assist in the establishment of the inspection system and to provide the inspectors with both initial and recurrent training. CAA inspectors were also sent to the FAA for on-the-job training and the other specialized training according to their training programs.

After 1997, four airworthiness inspectors were assigned to China Airlines for routine inspection work; two inspectors were responsible for the maintenance and two for avionics work. The inspectors assigned to China Airlines were recruited from the airlines with CAA and/or FAA A/P licenses and received formal

training from CAA consultants before commencing their jobs. The CAA published the inspector handbook in 1997.

Before the FAA IASA, the CAA had 10 flight operations inspectors and 11 maintenance inspectors. The CAA now has 28 flight operation inspectors (including cabin safety inspectors and dangerous goods inspectors) and 24 maintenance inspectors.

### **1.17.3.7 CAA International Connections**

Because the ROC is not a member of ICAO, the CAA was asked how it keeps up-to-date with international aviation regulations. The CAA stated that the Regulation and Policy Group, which is under the CAA Flight Safety Consultation Committee, provides regulation revision and procedures for the CAA and operators. In general, the CAA can search the latest status of FARs, JARs, and ICAO SARPs through the ICAO ESHOP and the IHS AV-DATA on-line searching system. Divisions in the CAA are responsible for monitoring compliance with SARPs contained in ICAO Annexes. The Divisions review ICAO Annexes related to regulations and revise the regulations, as necessary, once per year. There are no means for the CAA to take part in Working Groups of ICAO or to discuss ROC aviation safety matters with ICAO staff.

For the past few years, ICAO has been conducting audits<sup>22</sup> of ICAO Member States regarding compliance with the provisions of Annexes 1 (Personnel Licensing) 6 (Operations), and 8 (Airworthiness). Virtually all Member States have received at least one audit, which assesses a State's ability to meet its safety oversight obligations contained in the SARPs of those particular Annexes. ICAO does not assess ROC's safety oversight programs because the ROC is not an ICAO Contracting State.

### **1.17.3.8 CAA Aging Aircraft Program**

The CAA stated that, according to Article 137 of Aircraft Flight Operation Regulation, the operators shall obtain continuous airworthiness information from aircraft manufactures and to implement the required actions. The CAA is also

---

<sup>22</sup>The ICAO program is referred to as the Universal Safety Oversight Audit Program (USOAP).

continually monitoring web sites of aircraft manufacturers and their appropriate certification authorities in search of continued airworthiness information. As for the RAP, the CAA originally obtained the information from China Airlines. The CAA approved CAL's RAP on May 28, 2001, in accordance with Boeing's Repair Assessment Guidelines.

After the accident, by patterning after Direction Générale de l'Aviation Civile's (DGAC) practice, the CAA issued an Airworthiness Directive (AD 2002-09-002, Repair Assessment for Pressurized Fuselages) for aircraft type including B737, B747, MD DC-9/MD-80, and A300-B4-200 for the RAP. In addition, the CAA issued an Advisory Circular (AC120-020, Damage Tolerance Assessment of Repairs to Pressurized Fuselages) to require operators adopt the FAA-approved Repair Assessment Guidelines for the fuselage pressure boundary as part of their maintenance program.

### **1.17.3.9 The Regulatory Oversight of CAL Maintenance**

The CAA conducts scheduled inspection of operators and their maintenance organization and subcontractors to verify whether their maintenance activities are in compliance with CAA regulations. The CAA has established an annual inspection plan for routine/non-routine maintenance inspections and prepared the Airworthiness Inspector's Handbook to provide guidance for all inspectors.

CAA inspects the operator's maintenance operations for adequacy of procedures, facilities, equipment, trained personnel, technical information, aircraft/components and records in accordance with the established annual surveillance program. CAA regulations also require operator's management personnel to be trained in relevant regulations and company manuals.

Since 1997, CAL has had four airworthiness inspectors assigned for regulatory oversight. Inspections/surveillance are conducted annually in accordance with the job functions contained in the inspector's handbook. The objective of the inspection/surveillance is to maintain compliance with all applicable regulations, company policy, and maintenance manuals. Furthermore, inspectors also approve or accept documents prepared by the operator, such as aircraft maintenance programs, special operation programs, training programs and standard operation procedures (SOP).

In addition to CAA oversight, CAL also receives oversight from the FAA and JAA

for compliance with FAR 129, 145 and JAA 145 for adequacy of procedures, facilities, equipment, trained personnel, technical information, aircraft/components and records. The international inspection procedures parallel CAA's procedures.

## **1.18 Additional Information**

### **1.18.1 Wreckage Recovery**

#### **1.18.1.1 Introduction**

The Safety Council established a command post in Makung AFB immediately after confirmation of the accident. At the same time, the Aircraft Accident Central Emergency Response Center (AACERC) was established on the second floor of the Makung Airport Terminal Building with the Minister of Transportation and Communications (MOTC) as the on-scene commander, and the Directorate General of the CAA as the Deputy Commander. In the earlier stages, the AACERC and the Safety Council wreckage recovery operation were overlapped due to the combined effort to search for the victims, and recover wreckages as it came along. Soon after the wreckage salvage vessel Jan Steen arrived, the on-scene commanding authority was transferred from the AACERC to the ASC and the major tasks were then focused on the victims and the wreckage recovery from the ocean floor.

The wreckage recovery operation was divided into four phases with adjacent phases overlapping the previous one:

#### **Phase 1 (05/25-06/10, 2002)**

Floating debris and body recovery, the search for the recorders' ULB signal, and mapping of the wreckage spread.

#### **Phase II (06/02 – 07/03, 2002)**

Wreckage recovery by Asia-Pacific Inc..

#### **Phase III (06/14- 09/16, 2002)**

Jan Steen Salvage Ship Operation and the recovery of the two recorders

#### **Phase IV (09/16 – 10/17, 2002)**

Wreckage recovery via trawling.

The operations of those four phases are described in the following subsections.



During the months between late May and early October 2002, environmental conditions around the accident area were as follows:

- Wind Magnitude                                      Stage 3~5, gusting to stage 8
- Wind Direction                                        North and Southwest
- Underwater Current                                2 to 5 knots
- Underwater Current Direction                Northwest
- Wave Height    1~2 meters

It was later found that the depth of the wreckage spread was about 50 to 70 meters and the ocean floor where the wreckage resided was relatively flat with packed sand.

Three typhoons passed through the accident site during the wreckage recovery period, each typhoon delayed the salvage operation for approximately 6 to 8 days.

### **1.18.1.2 Phase I Operation**

The phase I operation commenced in the afternoon of the accident day as the first few pieces of floating wreckage, fuel traces, and bodies were spotted by the search and rescue helicopters. This phase consisted of three distinct operations: search and rescue operation for of the floating debris and bodies, mapping of the wreckage spread, and search for the recorders ULB signal.

### **1.18.1.3 Phase II Operation**

Asia-Pacific Inc. contracted by China Airlines, did the early phase of the wreckage recovery. The vessel used by Asia Pacific for the recovery operation was a 1,254-ton barge (Figure 1.18-1 left). It has a 250-ton crane and a team of 15 divers and was equipped with a decompression chamber. This barge had no propulsion capability; therefore it required tugboats and had to be anchored before the diving operation. The divers dove in a two-men team. For the 65 to 70 meter depth of water, working time on the seabed was limited to less than 30 minutes, including the time needed to descend from the ocean surface to the seabed. Depending upon the sea state divers would either come to the surface and go immediately into the decompression chamber, or be stopped several times at intermediate depth for decompression. In the latter case, the time spent in the decompression chamber could be reduced. During this phase of the

operation, Asia Pacific divers recovered Engines # 1 and #4, item 526, the R/H wing upper panel, item 487, the upper deck panel, item 546, and the L/H wing landing gear with the L3 door. It also recovered 15 bodies. Asia Pacific was decommissioned on July 3, 2002.

Initially, the recovered wreckage pieces were placed in the Makung Air Force Hanger. However, the wreckage pieces recovered by salvage vessels were relatively large, the Makung Air Force Hanger could no longer handle the volume of the wreckage. The recovered wreckage was placed on the Coast Guard's No. 3 dock (Figure 1.18-1 right).

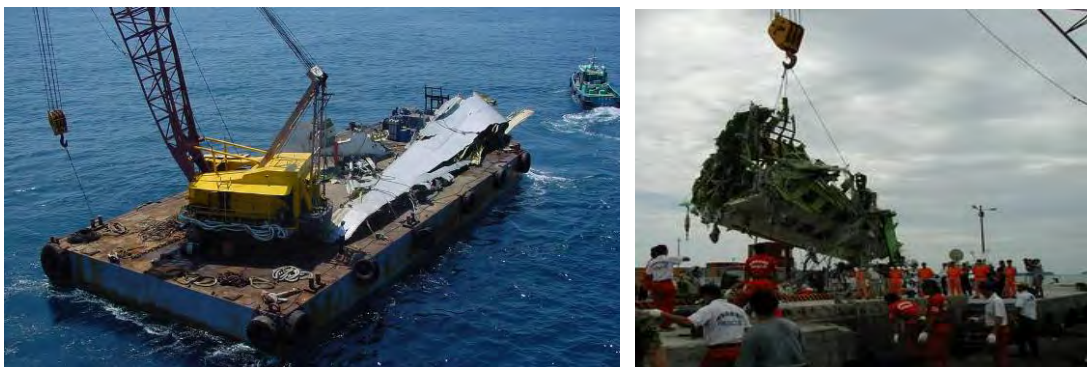

Figure 1.18-1 The Asia Pacific barge (left); the Coast Guard's dock (right)

#### 1.18.1.4 Phase III Operation

On June 12, 2002, the investigation team re-located the command post to the 5<sup>th</sup> floor of the Makung Harbor Building. The command post served as the command, control and communication center for the entire operation including the salvage vessel, wreckage spread survey ships, the coast guard, and the barges.

The salvage vessel Jan Steen of Global Industries (Figure 1.18-2), contracted by China Airlines, arrived Makung on June 14, 2002. Jan Steen equipped with a Dynamic Positioning System II (DP II), and a saturation diving chamber with a team of 16 divers. Jan Steen also equipped with a 100 HP Remote Operating Vehicle (ROV, Thales Sealion) with Simrad sonar, two 180-degree underwater video cameras, and two mechanical arms. If weather permitted, the Jan Steen divers and ROV could operate nearly 24 hours a day. However, because of the ocean current, a typical workday consisted of 12 to 16 hours of salvage operation.



Figure 1.18-2 The salvage vessel Jan Steen

There were two teams involved in the recovery of the recorders, the Navy divers and the Jan Steen divers. The Jan Steen divers recovered the CVR on June 18, 2002 and the Navy divers recovered the FDR on June 19, 2002.

The Distance between the two recorders was about 610 meters. Relative positions of the two recorders, as well as the wreckage distribution are shown in Figure 1.18-3.

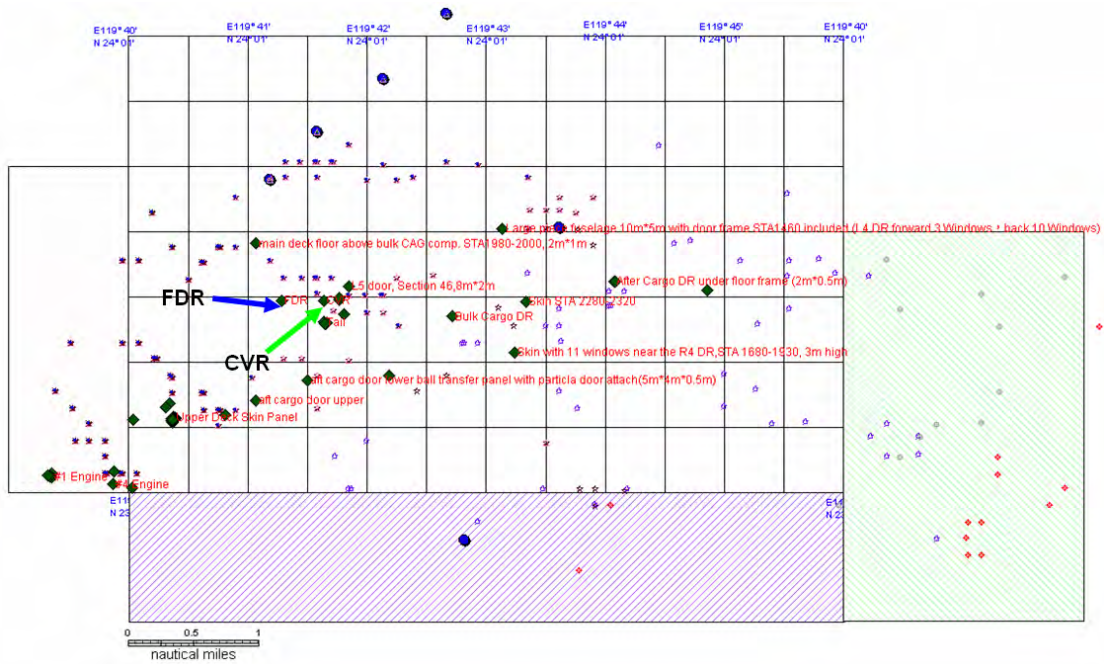

Figure 1.18-3 Relative position of the two recorders and the wreckage

As the mapping information became more precise, the wreckage spread was divided into four areas color coded as Red, Yellow, Green, and Blue, as indicated in Section 1.12. The areas and major wreckage pieces recovered from each area are described as Table 1.18-1:

Table 1.18-1 Major pieces recovered from each area

Zone	Corner Position	Findings
Red	N 24 02' 00" E 119 47' 00" N 24 02' 00" E 119 39' 48" N 23 59' 12" E 119 39' 48" N 23 59' 12" E 119 41' 00" N 23 56' 00" E 119 41' 00" N 23 56' 00" E 119 47' 00"	The Red Zone covered an area of approximately 73 square nautical miles (10.1 NM X 7.2 NM). This zone contains the earlier parts of the aircraft recovered in the wreckage debris spread along the flight path. Wreckages recovered from the red zone: empennage, part of Section 48, aft pressure bulkhead, most of Section 46 structure, Flight Data Recorder, Cockpit Voice Recorder, aft galley, Section 46 main deck floor, aft cargo compartment door, bulk cargo door, cargo compartment floor, and contents of the aft and bulk cargo compartment.
Yellow	N 23 59' 12" E 119 39' 48" N 23 59' 12" E 119 41' 00" N 23 57' 48" E 119 41' 00" N 23 57' 48" E 119 39' 48"	The Yellow Zone covered an area of approximately 1.8 square nautical miles (1.5 NM X 1.2 NM). This zone was generally referred to as the MWF. The wreckage found in the Yellow Zone: Sections 41, 42, 44, and part of Section 46, cockpit with instrument panels, both wings and wing flight control surfaces, wing center section, nose and wing landing gears, left body gear, forward cargo compartment door, and part of the four struts attached to the wings. Most of the submerged victims' bodies were recovered in this zone.
Green	N 23 57' 48" E 119 41' 00" N 23 57' 48" E 119 36' 00" N 23 54' 30" E 119 36' 00" N 23 54' 30" E 119 41' 00"	The Green Zone covered an area of approximately 13.5 square nautical miles (3.3 NM X 4.1 NM). This zone was ahead of the flight path. The wreckage found in the green zone: all four engines with part of the struts attached to each engine, engine cowls and various engine components. The right body gear was tangled with fishing nets.
Blue	N 24 01' 15" E 119 38' 00" N 24 01' 15" E 119 39' 50" N 23 57' 48" E 119 39' 50" N 23 57' 48" E 119 38' 00"	The Blue Zone covered an area of approximately 6.5 square nautical miles (3.6 NM X 1.8 NM). This zone was directly west of and adjoins the red zone. Although targets were initially identified in the blue zone, no wreckage was recovered from this area.

In this phase, additional 78 victims' bodies were recovered and 401 potential underwater targets were identified.

### 1.18.1.5 Phase IV Operation

In Phase III, Jan Steen had detected several wreckage pieces using ROV sonar,

indicating some of the wreckage was not identified by the previous survey operation. However, after recovering larger size wreckage, the use of divers and the ROV to recover the remaining smaller wreckage pieces became difficult and ineffective. Shifting sand at the seabed, tides, current, and typhoons caused many small pieces of wreckage to be imbedded in the sand of the ocean floor. After careful consideration, the Safety Council decided to use the trawling to complete the wreckage recovery.

China Airlines sponsored the trawling operation. CSIST was hired by China Airlines to provide technical support. The CSIST installed Integrated Navigation System on each trawler. A control center was established and equipped with functions such as GPS, track recording, trawling line management, and real time position reporting. It assisted trawlers to navigate at sea and provided information for the monitoring of the positions and tracks of the trawlers.

Jan Steen continued working in the beginning of this phase, and ended its task on September 16. The trawling operation began on September 16 and lasted until October 17. Five commercial trawlers were hired for this task. Planned working time was 7 days, 24 hours per day. All trawlers were equipped with a winch with a maximum lift weight of 2,000 kg. One barge and one tugboat were hired for temporary wreckage storage and transportation.

Throughout the trawling operation, the Northeast monsoon had begun to affect the weather in Penghu area. The operations were suspended several times due to bad weather. As the result of the trawling operation, a totally of 97 pieces of wreckage were recovered, most were structure and system parts. This effort was completed on October 17, 2002, thus ending the recovery operation.

#### **1.18.1.6 Wreckage Handling and Transportation**

The CI611 wreckage was transported from Makung to Taoyuan Air Force Base (TAFB) Hanger #1 and Hanger #2 to allow for the follow-on wreckage examination activities and for storage of the wreckage in one location. The wreckage was initially transferred by barge from two locations within the Makung Harbor to a port near Taoyuan where it was offloaded onto trucks. The wreckage was then transported by trucks to the hangers at TAFB where the red zone wreckage and other Section 46 structure was placed in Hanger 2, all other wreckage was stored in Hanger 1.

### **1.18.1.7 Wreckage Tagging**

As wreckage was recovered and brought to Makung, each large piece of wreckage was assigned a unique identifying number and a tag was attached. Each piece of wreckage from the red zone was assigned a separate tag. In some cases, small pieces of wreckage recovered en masse from the MWF were tagged collectively by the box. Some of those items were later given individual tags after examination by the investigators. Each tag had the wreckage ID number with the recovery latitude and longitude written on the tag. During the initial recovery stages, various types of tagging material were used but later, a coated canvas material was selected for its durability. These tags were colored yellow, red, or green based on the zone in which that particular wreckage piece was recovered. A white tag was attached to those parts for which a recovery location was not known, such as the pieces recovered by the fishing boats.

Tags were also applied to wreckage at the TAFB hangers when pieces of wreckage of potential interest were examined, typically for parts that had become separated during transportation.

During trawling operations, wreckage tagging was accomplished in Makung harbor. Because of the nature of the trawling operation, no precise recovery location was known. Instead, the recovery date and boat number was recorded on the tag. Since each trawling boat was assigned to a specific trawling zone, the boat number corresponded to a specific trawl zone. If needed, the records could be interrogated to help narrow the ocean bed location of the recovered components.

### **1.18.1.8 Wreckage Database**

The Master Wreckage Database was developed using an Excel spreadsheet that contained known data on each piece of wreckage that was tagged. The various data fields for each piece of wreckage allowed for data sorting capabilities later in the investigation and have been merged into the CI611 Database. The Master Wreckage Database containing 719 larger pieces of the wreckage recovered is shown in Appendix 13.

### **1.18.1.9 Summary**

As a whole, the wreckage recovery operation for the CI611 accident

investigation lasted nearly 5 months, recovered approximately 1,500 pieces, and 175 bodies. After combining all the survey sources and the wreckage recovery locations, the wreckage map is shown in Figure 1.18-4. There are still 50 bodies and a major portion of the Section 46 uncovered.



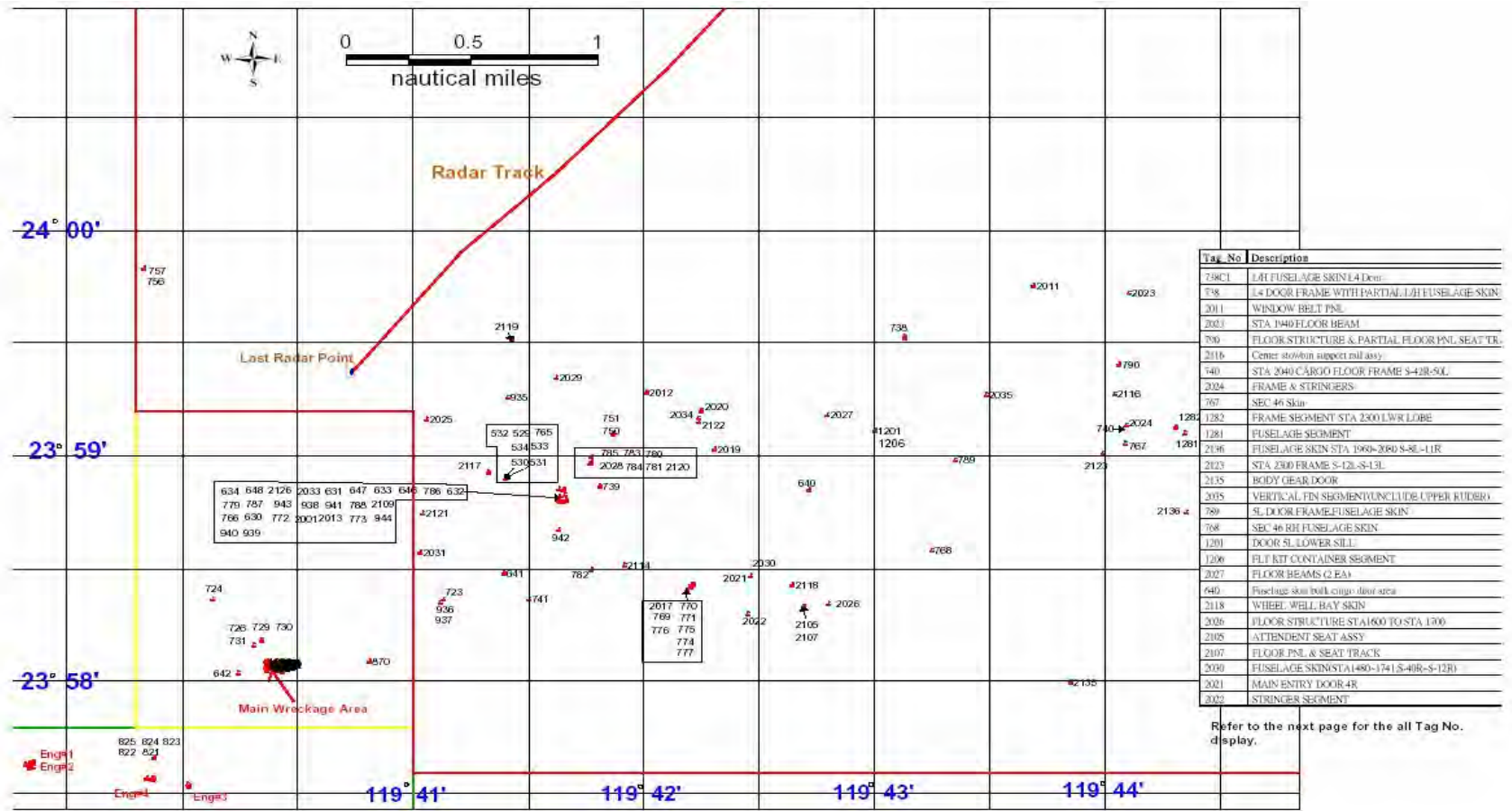

Figure 1.18-4 The wreckage distribution map

## **1.18.2 Security**

After checking all records with regard to: Outward Aircraft Examination, General Declaration, Passenger Manifest, Cargo Manifest, Shipper's Letter of Instruction, Passengers Insurance Records, and Passenger Background Check, the Safety Council found no evidence of security threats related to the CI611 flight.

## **1.18.3 Repair Assessment Program**

### **1.18.3.1 Background**

A structural-failure accident to an aircraft operating as a passenger flight in the United States of America in 1988 raised significant public and aviation industry concerns about the airworthiness of aging transport-category aircraft. The U.S. Congress passed the Aviation Safety Research Act of 1988. The Act increased the scope of the U.S. Federal Aviation Administration (FAA) to include research improving maintenance technology and detecting the onset of crack, de-lamination, and corrosion of aircraft structures.

The FAA organized number of conferences dealing with aging aircraft issues. The first of these was held in June 1988. As a result, in August 1988, the Airworthiness Assurance Task Force (AATF) was established as a sub-group of the FAA's Research, Engineering and Development Advisory Committee representing the interests of aircraft operators, aircraft manufacturers, regulatory authorities and other aviation groups. The AATF initially set forth five elements for keeping the aging aircraft fleet safe (a sixth being added later).

The elements were:

- Structural Modification Program;
- Corrosion Prevention and Control Program;
- Structural Maintenance Program Guidelines;
- Review and Update Supplemental Structural Inspection Documents;
- Damage tolerance of Repairs; and
- Program to preclude widespread fatigue damage in the fleet.

In January 1991, the FAA established the Aviation Rulemaking Advisory Committee (ARAC) to provide advice and recommendations concerning the full range of the FAA's safety-related rulemaking activity. In November 1992, the

AATF was placed under the auspices of the ARAC and renamed the Airworthiness Assurance Working Group (AAWG). One of the tasks assigned to the AAWG was to develop recommendations concerning whether new or revised requirements and compliance methods for structural repair assessments of existing repairs should be initiated and mandated for the identified group of aging aircraft. The Boeing 747-200 model was one of the groups identified as aging aircraft.

Initially the aircraft manufacturers began to prepare model specific repair assessment guides. These guides were presented to operators to provide feedback for acceptability and improvement. During this period, the AAWG conducted two surveys covering some 1051 repairs on 65 aircraft that had been retired from operational usage. The findings of both surveys were issued in a report in December 1996. Both surveys found that about 40% of the repairs were adequate and the remaining 60% required additional supplemental inspections. The AAWG recommended that repair assessment operational rules require a damage tolerance assessment of fuselage pressure boundary repairs (fuselage skins, door skins and bulkhead webs) for all aging aircraft models.

In December 1997, the FAA issued a Notice of Proposed Rulemaking (NPRM 97-16) on the repair assessment subject. The final rule was published on April 25, 2000 and was effective on May 25, 2000. The applicable new rules are 14 CFR 91.410, 121.370, 125.248, and 129.32. The final rule states that no operator could operate nominated aircraft (including Boeing 747-200 models) beyond a certain number of flight cycles or May 25, 2001, whichever occurs later, unless its operations specifications have been revised to reference repair assessment guidelines and those guidelines are incorporated in its maintenance program.

For the models of the Boeing 747, the flight cycle implementation time is 15,000 cycles.

### **1.18.3.2 Issues Related to Older Repairs**

Repairs are a concern on older aircraft because of the possibility that they may develop, cause, or obscure metal fatigue, corrosion, or other damage during service. This damage might occur within the repair itself or in the adjacent structure, and might ultimately lead to structural failure. The objective of the RAP

is to assure the continued structural integrity of the repaired and adjacent structure.

In general, according to the FAA NPRM 97-16, repairs present a more challenging problem than the original structure because each repair is unique and tailored in design to correct particular damage to the original structure. Whereas the performance of the original structure may be predicted from tests and from experience on other aircraft in service, the behavior of a repair and its effect on the fatigue characteristics of the original structure are generally not known to the same extent as for the basic un-repaired structure.

NPRM 97-16 also stated that the available service record and surveys of out-of-service and in-service aircraft have indicated that existing repairs generally perform well. However, repairs may be of concern as time-in-service increases. When aircraft age, both the number and age of the existing repairs increase. Along with this increase is the possibility of unforeseen repair interaction, autogenous (i.e. self-produced) failure, or other damage occurring in the repaired area. The continued operational safety of these aircraft depends primarily on a satisfactory maintenance program (inspections conducted at the right time, in the right place, using the most appropriate technique). In addition, some repairs described in the aircraft manufacturers' Structural Repair Manuals (SRM) were not designed to current standards. Repairs accomplished in accordance with the information contained in the early versions of the SRM's may require additional inspections if evaluated using the current methodology.

### **1.18.3.3 Repair Assessment Process**

The Structures Task Groups was formed to develop a common industry approach for all aging aircraft models. Industry agreement was reached on a general approach consisting of three stages of assessment.

The stage 1 processes were to gather repair data based on visual inspection, and allows operators identify the areas of the aircraft where structural repairs may require supplemental inspection to maintenance damage tolerance. The stage 2 processes were to determine a repair category by using the data collected in stage 1. The stage 3 processes were to determine the structural maintenance requirements.

The operators will define the inspection threshold based on the time of repair

installation, if the supplemental inspection and/or replacement requirements were required.

#### **1.18.3.4 Repair Assessment Threshold and Grace Period**

The introduction of mandatory continuing airworthiness requirements, such as the RAP, involves the determination of compliance threshold and grace periods. This kind of the inspection program is developed by aircraft manufacturers and approved by the relevant State of Design. The State of Registry then determines what aspects of the program should be mandatory for aircraft of that type on their register.

According to the FAA Airworthiness Directives Manual, two types of analysis are typically necessary when determining compliance times for a mandatory continuing airworthiness requirement: threshold and grace periods.

A compliance threshold stipulates the time in service of the aircraft by which action should be taken to detect or prevent the unsafe condition. It may be specified in terms of flight cycles, calendar time or flight hours, depending on which are more critical for the specific problem being addressed.

Grace periods provide an allowance for aircraft, components, or engines that have already exceeded the compliance threshold at the time the continuing airworthiness requirement is introduced. The intent of allowing a grace period is to avoid aircraft being grounded unnecessarily. In determining the appropriate grace period, the degree of urgency of the unsafe condition must be balanced against the amount of time necessary to accomplish the required actions, the availability of necessary replacement parts, operators' regular maintenance schedules, and other factors affecting the ability of operators to comply. In some cases it may be necessary to ground aircraft, but in most cases the grace period can be selected to avoid grounding and interference with normal maintenance schedules, while still obtaining expeditious compliance.

#### **1.18.3.5 Approved B747 Repair Assessment Guideline**

According to Boeing Repair Assessment Guidelines - Model B747, document number D6-36181, repairs were to be examined by the following points and the FAA approved Boeing 747 RAP process can be expressed in the logic flow diagram as shown in Figure 1.18-5:

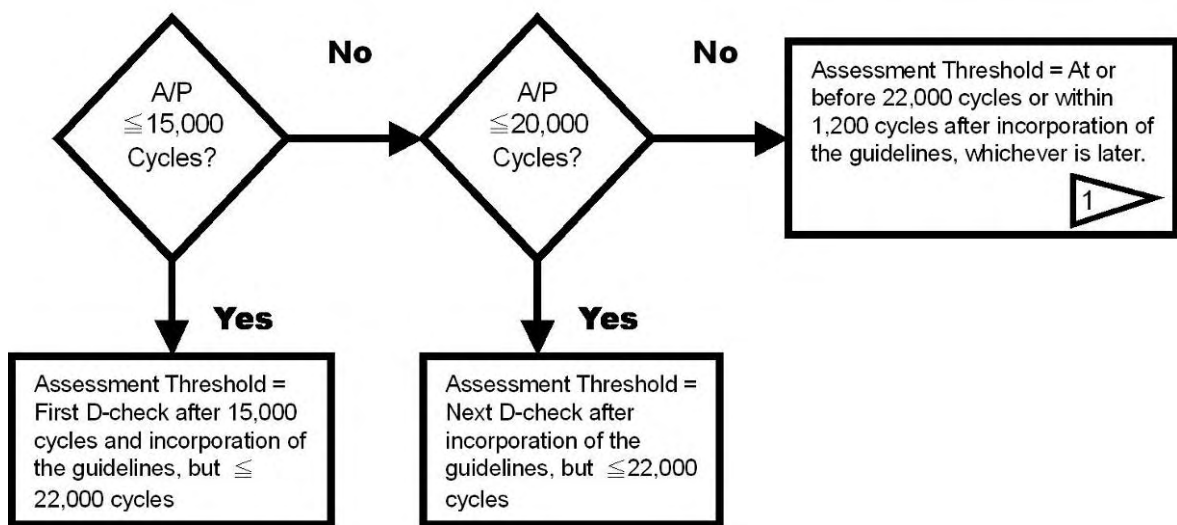

Legend:

A/P Airplane cycles on May 25, 2000



22,000 cycles is in agreement with access to majority of areas in SB 747-53-2349

Figure 1.18-5 FAA approved Boeing 747 repair assessment guideline

**Aircraft with flight cycles less than 15,000 cycles on the rule effective date of May 25, 2000**

*The guidelines must be incorporated into the maintenance program at 15,000 cycles, or within one year of the effective date of the rule, whichever is later. The assessment process on these aircraft is to begin (e.g. at least complete repair examination) at or before the next major check (D-check equivalent) after the incorporation of the guidelines, but not to exceed 22,000 cycles.*

**Aircraft with flight cycles greater than 15,000 but less than 20,000 cycles on the rule effective date of May 25, 2000**

*The guidelines must be incorporated into the maintenance program within one year of the effective date of the rule. The assessment process on these aircraft is to begin (e.g. at least complete repair examination) at or before the next major check (D-check equivalent) after the incorporation of the guidelines not to exceed 22,000 cycles.*

## **Aircraft with flight cycles greater than 20,000 cycles on the rule effective date of May 25, 2000**

*The guidelines must be incorporated into the maintenance program within one year of the effective date of the rule. The assessment process is to begin (e.g. at least complete repair examination) at or before 22,000 cycles or within 1,200 cycles, whichever is later, after the incorporation of the guidelines.*

### **1.18.3.6 Determination of the Assessment Threshold**

According to the FAA-approved Repair Assessment Guideline, the reason for using 22,000 flight cycles as the Assessment Threshold was because 22,000 cycles is in agreement with requirements to gain access to a majority of areas specified in SB B747-53-2349<sup>23</sup> (FUSELAGE-INSP BASE ON FATIGUE TEST RESULT, Repetitive Inspection of Fuselage Internal Structure to Detect Cracks). According to the SB, the 22,000 flight-cycle was determined by the B747 Structures Working Group.

In response to the Safety Council's query regarding why and how the RAG D6-36181 decided to adopt the implementation period of SB B747-53-2349, Boeing stated as following:

*“Boeing has reviewed available material documenting the Structures Task Group meetings regarding implementation period. Boeing has found no record of the implementation period as the subject of specific discussions with industry/regulatory groups. However, the document as a whole was generated by, and reviewed by, the Structures Task Group as indicated in the preface material in the document.*

*There are two reasons why the 22,000 cycles assessment threshold for the airplanes beyond the 15,000 cycles threshold was chosen.*

#### *(1) Technical Justification*

*The fatigue testing that resulted in SB B747-53-2349 also*

---

<sup>23</sup> Repetitive inspection of fuselage internal structure to detect cracks, which is an aging aircraft SB and not directly related to RAP.

*tested the fuselage skin lap splices and circumferential splices and resulted in an external lap splice inspection requirement at 22,000 cycles per SB B747-53-2367 (FUSELAGE-SKIN-BODY SKIN LAP JOINT INSP BASE ON FATIGUE TEST). The details of these splices are duplicated in the SRM skin repairs that are the subject of the RAG. The data generated to establish the 22,000 cycles threshold for the skin lap splices is also applicable to the skin repairs.*

(2) *Operational Considerations*

*As previously stated, the 22,000 cycles threshold corresponds to a mandated major maintenance requirement in SB B747-53-2349. This bulletin requires internal access to most of the fuselage. One goal of the RAP was to require that the assessment be accomplished no later than the next major maintenance visit beyond DSG. The existing mandated inspection per SB B747-53-2349 satisfied this goal.”*

In response to a the Safety Council query regarding why and how the B747 Structures Working Group determined the implementation period to be 22,000 flight cycles, Boeing stated as following:

*“The Structures Task Group primarily focused on the assessment threshold of 15,000 cycles. This was based on extensive durability analysis of SRM repairs. The maximum assessment threshold of 22,000 cycles was chosen to agree with the existing mandated internal access requirement per SB B747-53-2349. This threshold can also be justified technically by comparison to SB B747-53-2367. The inspection requirements for the internal structure per SB B747-53-2349 and the skin lap splices per SB B747-53-2367 were based upon extensive fatigue testing and the requirements for these bulletins were reviewed by the Structures Task Group independent of the RAP. The skin splices, which replicate the details of a typical SRM skin repair, were closely monitored during the fatigue testing for crack initiation and progression of crack. The data from this testing was used to establish the threshold.”*



### **1.18.3.7 China Airlines RAP**

China Airlines operated Boeing 747 aircraft, including B-18255 that was covered by the requirements of the RAP. The airline complied with the requirements of the FAR 129<sup>24</sup> and produced a Repair Assessment Manual.

CAL Structures Section of the System Engineering Department was responsible for evaluating the RAP for implementation. The manager of the Structures Section stated that the Structures Section received a telex from Boeing regarding a RAP training workshop in 2000. He was aware that there were several aircraft in the company over 20 years old at the time. Therefore, he sent two engineers to Boeing for RAP training and started to plan for RAP implementation.

According to the CAL documents, after receiving the Boeing Repair Assessment Guideline D6-36181, the System Engineering Department issued EO 740-53-00-0003 (Fuselage Pressurized Skin Inspection for Specific Repair Conditions) on May 21, 2001. On May 24, 2001, the System Engineering Department issued procedure QP08ME119 (Aircraft Repair Assessment Process Implementation). The CAA approved the CAL's proposal for Repair Assessment Manual on May 28, 2001.

#### **1.18.3.7.1 RAP for B-18255**

Records indicate that the accident aircraft, B-18255, had accumulated 19,447 flight-cycles on May 25, 2000, and 20,402 flight-cycles on May 25, 2001. According to Boeing RAG D6-36181, B-18255 should begin the assessment process (at least complete repair examination) at or before the next major check (D-check equivalent) after the incorporation of the guidelines and prior to 22,000 cycles. On October 2, 2001, several departments of the Engineering and Maintenance Division, including Quality Assurance, Maintenance Planning, Production Planning, Structural Maintenance, APG, System Engineering, and NDI shop, held a meeting regarding the B-18255 RAP implementation assessment. According to the manager of the Structures Section and the meeting minutes, the repair assessment of B-18255 was scheduled at the

---

<sup>24</sup> FAR 129 governing the operation within the United States of each foreign air carrier.

7C-Check (November 2002). The reason for scheduling repair assessment at the 7C-Check was that there was insufficient information regarding the records of B-18255 repair doublers. Therefore, the meeting decided to document the repairs on B-18255 during the 6C-Check so that a better idea of how much time may be required to complete the repair assessment at the 7C-Check.

As stated in Section 1.6, CAL structural engineers completed the doubler mapping of B-18255 during the 6C-Check in November 2001.

## 1.19 Wreckage Reconstruction

There were three activities related to the wreckage reconstruction: 2D hardware reconstruction, 3D hardware reconstruction, and 3D software reconstruction.

### 1.19.1 2D Hardware Reconstruction

In order to provide effective and systematic examination of the recovered wreckage, and to assess the structural breakup sequence of the CI611 flight, a 2D hardware reconstruction was first prepared at Hanger #2 of the Taoyuan Air Force Base (TAFB). The 2D hardware reconstruction was based on the wreckage distribution of the aircraft as shown in Figure 1.19-1. Only the wreckage parts of Section 46 were reconstructed according to station number and stringer number of the original aircraft. The centerline of the aircraft belly served as the centerline of the 2D reconstruction on the floor of Hanger #2. The aircraft was facing the front door of the hanger and the wreckage pieces were laid symmetrically about the centerline. The 2D hardware reconstruction is shown in Figure 1.19-2.

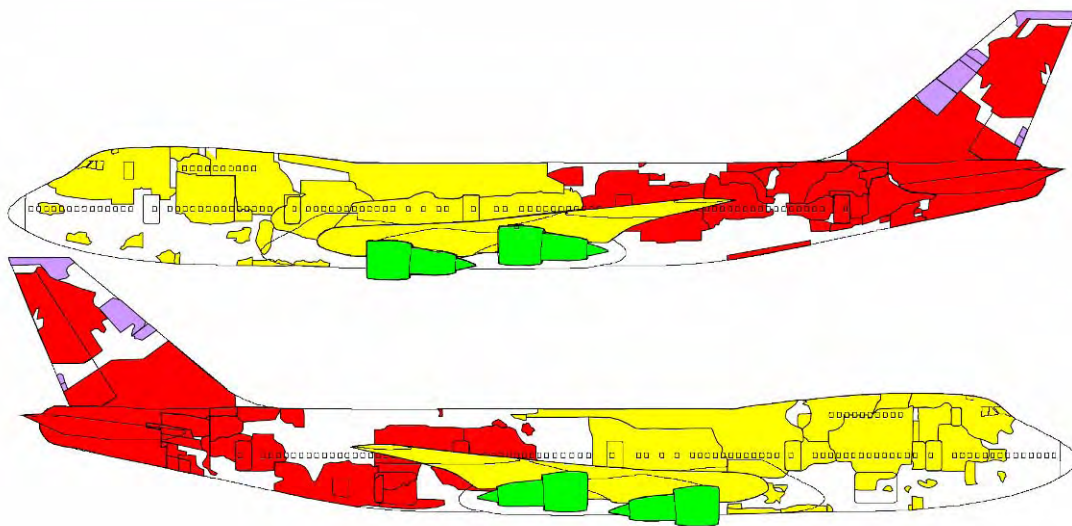

Figure 1.19-1 Relative location of the recovered wreckage pieces



Figure 1.19-2 2D hardware reconstruction at TAFB Hanger #2

### 1.19.2 3D Hardware Reconstruction

The objective of the 3D hardware reconstruction is to provide the investigators a 3D perspective of the size and shape of each wreckage pieces relative to the others, to examine the overall force distribution as the breakup of the aircraft took place, and to provide a visual environment to the investigators for the understanding in the relationship of the wreckage pieces as the breakup of the aircraft occurred. The 3D reconstruction started from STA 1320 to the end of the bulkhead, which covers part of the Section 44, the entire Section 46, and part of the Section 48. There are a total of 34 pieces of the recovered wreckage pieces that have been posted onto the frame. The 3D hardware reconstruction was commenced near the end of 2002, and completed on April 17, 2003. The final product of the 3D hardware reconstruction is shown in Figure 1.19-3 and 1.19-4.



Figure 1.19-3 3D hardware reconstruction (right side)



Figure 1.19-4 3D hardware reconstruction

### 1.19.3 3D Software Reconstruction

The purpose of a virtual reconstruction system, the 3D Software Wreckage Reconstruction and Presentation System (3D SWRPS), was to assist in the investigation both for CI611 and future accidents when in-flight breakup is involved. It combines information related to the wreckage data, 3D Laser scanning method, and the graphics technology developed by the Safety Council's investigation Laboratory.

Data included for the development of 3D SWRPS are shown in Table 1.19-1:

Table 1.19-1 Data included for the development of 3D SWRPS

Scanning	Description	Model Types	Date
1	3D reference model	B747-200 CATIA Model (high resolution)	11/25/2002
2	3D reference model	B747-200 Animation Model (low resolution)	11/02/2002
3	3D reference model	CAL B747-200 Cargo aircraft model	12/16/2002
4	CI611 wreckage	161 pieces of wreckage model	01/20/2003

In order to model quickly and precisely the CI611 wreckage of sections 44/46/48, a long-range 3D laser scanner was used to digitize the wreckage pieces at TAFB. Architecture of 3D SWRPS is described in the following:

- 3D object digitizing: Once the laser scanner scanned each individual piece, it was then digitized. It processes organized point clouds, as produced by most plane-of-light laser scanner and optical systems. (Figure 1.19-5)
- Aligning Multiple Data sets: During digitizing process, investigators either need to rotate the wreckage or move the 3D laser scanner in order to measure all of wreckage surface. As a result, the digitizing process produced several 3D scans expressed in different three-dimensional orthogonal coordinates systems. This step consists in bringing all the scanned pieces into the same coordinate system.
- Merging Multiple Data sets: a 3D-graphic virtual reconstruction allows investigators automatically to merge a set of aligned 3D scans of wreckage pieces into a reference mode, which were obtained from the same type of aircraft scan and Boeing's CATIA model. This procedure reduces the noise in the original 3D data by averaging overlapped measurements. (Figure 1.19-6)

- Polygon Editing and Reduction: In order to control the computer's memory budget, this step uses the polygon reduction tool to reduce the size of the 3D model.
- Manually edit several surfaces: with irregular surfaces that could cause data loss.
- Texture Mapping: Investigators can create texture-mapped models from digitized color 3D data.
- In-flight Breakup Animation: Major function of this module is to simulate the in-flight breakup sequence, by combining the radar ballistic trajectory, wind profile data, and the wreckage 3D model data in a time history.

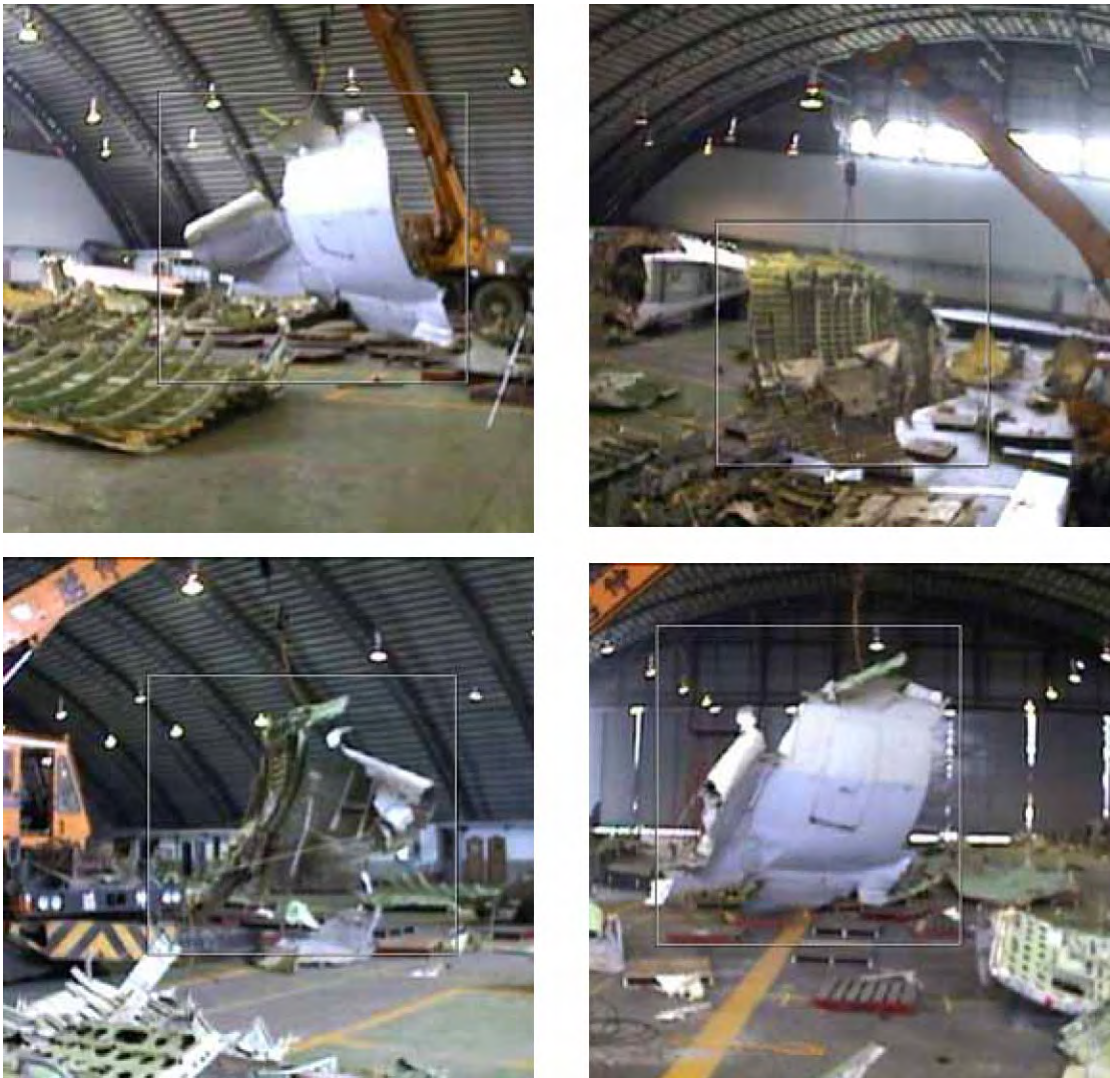

Figure 1.19-5 Wreckage digitizing process (item 640)

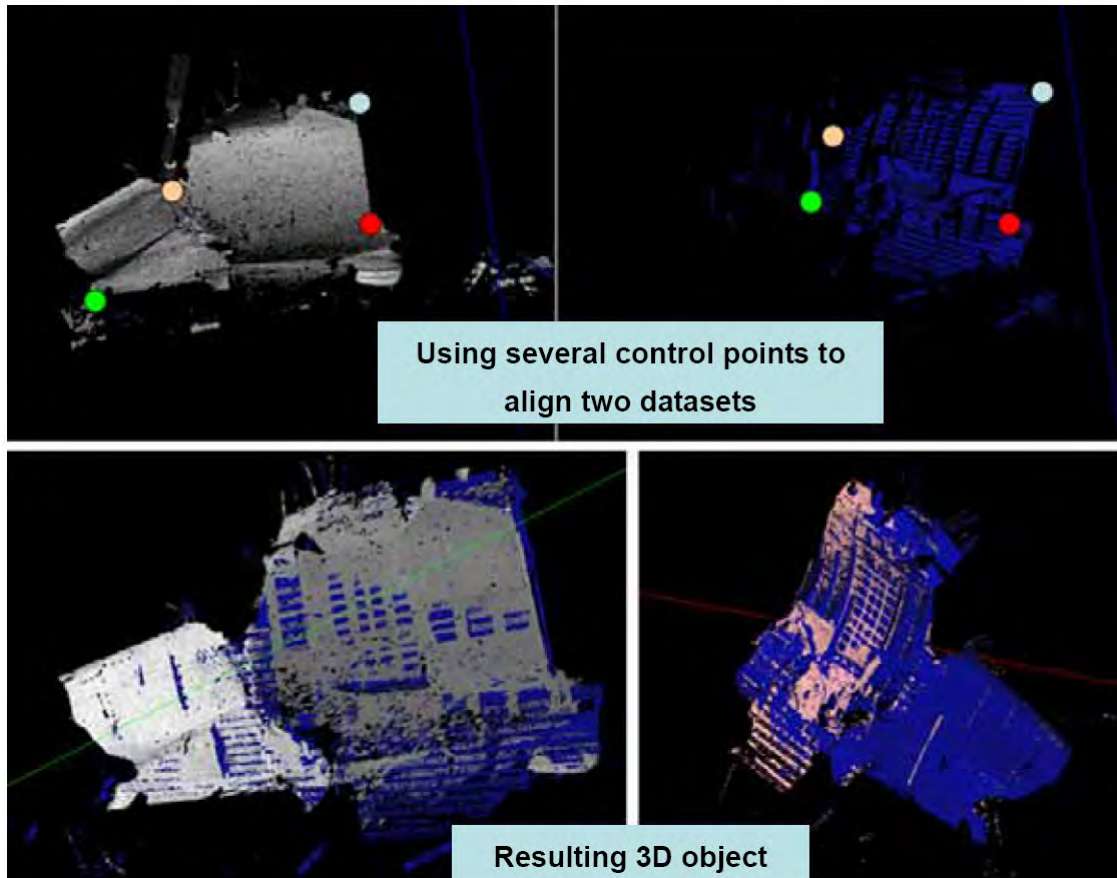

Figure 1.19-6 Aligning of multiple datasets (item 640)

Figure 1.19-7 shows the comparison of 2D layout and 3D software reconstruction along the left side of section 46. Figure 1.19-8 shows the comparison between 3D hardware reconstruction and the 3D software reconstruction.

Advantages of the 3D SWRPS are:

- a. No disposal problem;
- b. Re-usability, once developed, the methodology can be used for other accident investigations;
- c. Only one-half of the cost as compared to the hardware reconstruction; and
- d. Flexibility in combining with simulation program for better analysis support.



(a) 2D layout with body fracture sequences

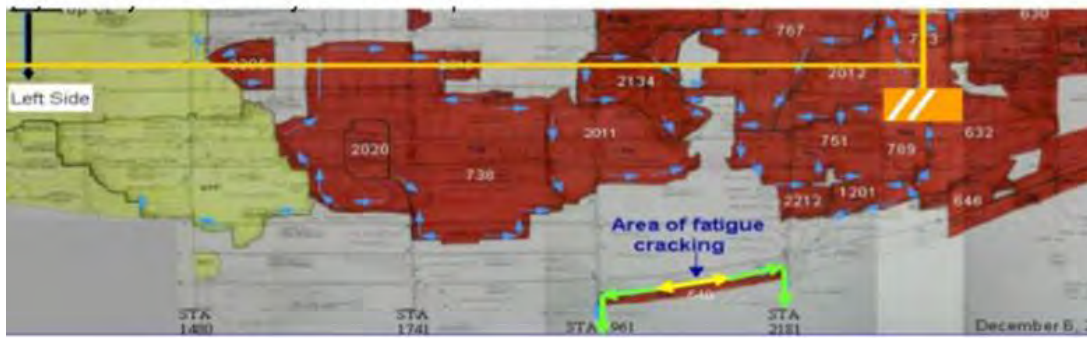

(b) 3D software reconstruction with reference frame

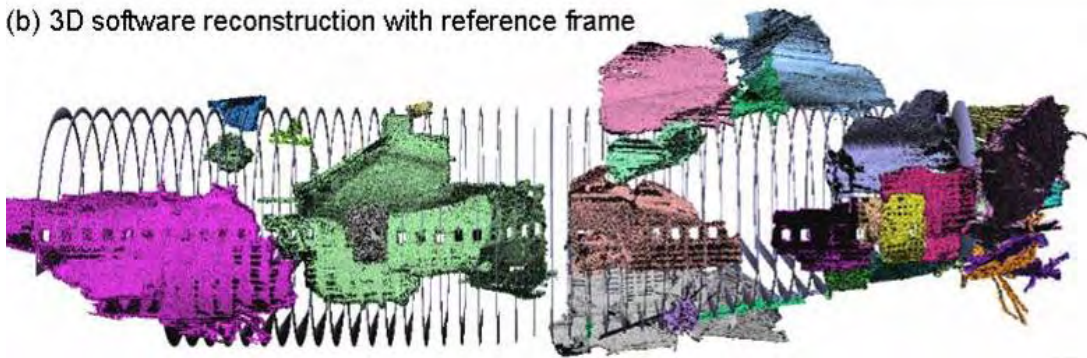

Figure 1.19-7 2D layout and 3D software reconstruction (left side)



Figure 1.19-8 3D hardware and software reconstruction

**Intentionally left blank**

## 2. Analysis

This chapter provides an analysis of the information documented in Chapter 1 of this report, which is relevant to the identification of cause related findings and conclusions. It also provides an analysis of safety deficiencies identified during the course of the investigation that may or may not be related to the accident but nevertheless involve risks to safe operations. By highlighting those safety deficiencies, or risks, along with the cause related findings, the Safety Council serves the public interest. It also discharges ASC's moral responsibility to publish whatever it learns in the course of an investigation that others may use to reduce risk and the probability of future accidents.

Chapter 2 begins with a general description (section 2.1) of the factors that were examined and ruled out. This section also describes a phenomenon in the FDR data, prior to the breakup of the aircraft.

Section 2.2 highlights what it believes establishes the most probable scenario of the in-flight breakup of CI611. The Safety Council concludes that the breakup was highly likely due to a structural failure in the aft lower lobe section of the accident aircraft.

Section 2.3 describes the 1980 tail strike repairs of the accident aircraft. Section 2.4 discusses maintenance related issues, including the organizational and management factors relevant to this accident, as well as the risks involved. Section 2.5 provides a structural failure analysis of fatigue cracks found on the aft fuselage during the wreckage examination. Section 2.6 describes the sound spectrum analysis of the CVR. Section 2.7 describes the analysis of unexpected

switch positions for the aircraft pressurization and pneumatic systems on the CM-3 panel, and the possibility of cabin over pressure. Section 2.8 describes the victim's injury related issues. Section 2.9 provides the ballistic analysis of the wreckage pieces matched with the primary radar track of the accident aircraft, the wreckage pieces detected by the primary radar, and the position of the wreckage pieces recovered from the ocean floor.

## **2.1 General**

The pilots and flight engineer were certificated and qualified in accordance with applicable CAA regulations, and CAL company requirements. The cabin crewmembers were qualified in accordance with the CAL training manual. During the course of the investigation, the Safety Council concluded that this accident was unrelated to air traffic services. Based on FDR and CVR recordings, the Safety Council found no anomalies that could relate this accident to the performance of the flight crew or cabin crew.

Based on the radar track data shown in Section 1.8, the accident aircraft suffered an in-flight breakup as it approached its cruising altitude of 35,000 ft. Several possible scenarios that might have led to the in-flight breakup were examined. They are as follows:

1. Midair collision
2. Engine failure/separation
3. Weather/natural phenomena
4. Explosive device
5. Fuel tank explosion
6. Cargo door opening
7. Cabin overpressure
8. Hazardous cargo/dangerous goods
9. Structural failure

Based on the information presented in Chapter 1, the Safety Council concludes that the in-flight breakup of CI611 was due to structural failure. A combination of analytical methods was used to rule out the remaining possible scenarios as described in the following subsections. After careful observation of the FDR data, the Safety Council also analyzes the phenomenon exhibited by the vertical and

lateral acceleration data.

### **2.1.1 Midair Collision**

There were five radar stations that tracked the flight path of CI611; two primary radars and three secondary radars. Those five radar stations tracked CI611 from three different directions; north, southeast, and southwest. None of the radars showed any other flights or any detectable flying objects in the vicinity of CI611 at the time of the accident. The primary radar data showed pieces of the aircraft, only after the breakup, and revealed no other objects approaching the accident aircraft prior to the breakup, nor there were any aircraft reported missing. Further, the Safety Council found no components other than the wreckage pieces from the accident aircraft. Thus, the Safety Council rules out the possibility of a midair collision of the CI611 aircraft due to either other flights or any foreign objects.

### **2.1.2 Engine Failure and Separation**

All four engines were recovered, some with struts attached, as stated in section 1.12. Detailed examinations revealed that the fuse pins of Engines #1, 3, and 4 remained intact at all engine positions with a portion of the strut still attached to the wing fittings and links. The #2 engine fuse pin remained connected with the diagonal brace of the left wing. Therefore, the Safety Council ruled out the possibility of engine(s) separation as a cause of the in-flight breakup.

Neither CVR nor FDR data revealed any indication of engine failure or other abnormalities prior to the breakup. A slight rise of the EPR parameter for engines #2 and #4 of the FDR were observed, but those rises were well within the normal operational range of the engines and therefore can not be considered as abnormal engine operation. Detailed examination of the engines revealed no indication of uncontained engine failures. All damage was attributed to severe damage caused by impact forces. Therefore, the Safety Council concluded that the engines of CI611 were not a factor of the in-flight breakup.

### **2.1.3 Weather or Natural Phenomenon**

Based on the weather information contained in Section 1.7, there were no adverse weather conditions at the time of the accident. The computed wind data from the FDR indicated no turbulence encountered by CI611 prior to the accident,

nor there were any conversations among the flight crewmembers indicating encounters with clear air turbulence. There were several flights at the time of the accident along the A1 flight path, none experienced any unusual weather condition.

Detailed examination of the wreckage revealed no indication of impact by external objects, nor there was any sign of lightning damage. Therefore, the Safety Council concluded that weather conditions and natural phenomenon were not a factor of the in-flight breakup.

#### **2.1.4 Explosive Device**

Detailed examination of the wreckage revealed no obvious characteristics of high-energy explosive damage. There was one small puncture with “spike-tooth” features at the bottom of item 738. A similar puncture was found in the aft portion of the fuselage of TWA800<sup>25</sup>. The source of the spike-tooth puncture on TWA800 and on C1611 were considered to be caused by lower order events from the breakup of the aircraft and flying debris, not from high-energy explosives. Therefore, the Safety Council ruled out the possibility of explosive devices as a factor of this accident.

#### **2.1.5 Fuel Tank Explosion**

Because of the TWA800 accident in 1996, special attention was directed to examine the possibility of center fuel tank overpressure. The wreckage examination revealed that the center fuel tank section was intact at water impact. Detailed examination of the wreckage pieces, especially the examination of the wing and center fuel tanks revealed no accumulation of soot within the fuel vapor vent stringer channels or any indication of heat or fire damage. The center and wing fuel tanks were all recovered with the main fuselage of sections 41, 42, and 44. Further, there was no correlation of the wreckage distribution of C1611 in the sea with the wreckage distribution pattern of the TWA800 accident.

One proposed theory was that an overpressure of the wing center section (center fuel tank at STA 1000 to STA 1241) could cause downward movement of

---

<sup>25</sup> July 17 1996, Trans World Airways Flight 800 accident.

the keel beam that could then compromise the fuselage pressure vessel somewhere in the vicinity of STA 1350. However, had there been an overpressure that caused the keel beam to move downward, there would have been a relative displacement between the wing upper skin and wing lower skin in the wing center section area. This would require a fracture of the span-wise beam and spar structure. The lower panel deformation between span-wise beams and spars indicates that the internal beam and spar structure had not been compromised as it was in place to restrict the upward movement of the lower panel at the time of water impact. Without the fracture of the spar-wise beam and spar structure, the keel beam could not translate downward due to an overpressure event.

Therefore, the Safety Council ruled out the possibility of a center fuel tank explosion as a factor of the in-flight breakup.

### **2.1.6 Cargo Door Opening**

Wreckage examination indicates that the forward cargo door, aft cargo door, and bulk cargo door were closed and remained intact when the aircraft broke up. Therefore, the Safety Council ruled out the possibility of a cargo door opening as a factor of the in-flight breakup.

### **2.1.7 Cabin Overpressure**

Because of unexpected switch positions observed on the pressurization and pneumatic system control panels, the possibility of over pressurization was considered, as illustrated in Section 2.7. Although some of the switch positions may have been related to actions on the part of CM-3 during the last moments of the flight, this possibility can not be confirmed. It is more likely that the switch positions resulted from forces during the in flight breakup or water impact, or subsequent damage during wreckage recovery handling or transportation. Moreover, the CVR revealed no evidence that flight crew was encountering pressurization difficulties during the climb. Thus, the Safety Council ruled out the possibility of cabin over pressure as a factor of this accident.

### **2.1.8 Hazardous Cargo and Dangerous Goods**

The cargo manifest was reviewed thoroughly and there were no known

hazardous cargo or dangerous goods aboard CI611. Detailed examination of the wreckage pieces and victims' remains revealed no chemical substances that could be related to hazardous materials or dangerous goods. Therefore, the Safety Council concluded that hazardous materials and dangerous goods were not a factor of the in-flight breakup.

### **2.1.9 Vertical Acceleration Data prior to the Breakup**

By carefully examining the acceleration data from the FDR, one can observe that 10 seconds prior to the loss of power of the flight recorders, there was a slow increase in both the vertical acceleration and lateral acceleration, as shown in Figure 2.1-1. By comparing the lateral acceleration parameter of the previous two flights of B-18255, before approaching its cruising altitude of 35,000 ft, similar oscillatory behaviors were found, as shown in Figure 2.1-2. Comparison was also made of the vertical acceleration parameter of CI611 and the two previous flights. A more pronounced increase in magnitude of the vertical acceleration was observed. These data led to the consideration that a preliminary breakup of the fuselage structure might have been in progress before the power loss of the FDR.

However, on Boeing 747 aircraft, the accelerometers are mounted along STA 1310, which is near the aircraft's center of gravity. These instruments measure accelerations of the aircraft associated with maneuvering, turbulence etc. They do not accurately measure the frequencies of vibrations that may pass through the fuselage. With the limited data available, the Safety Council could not determine what led to the slight increase in vertical acceleration prior to the break-up of the aircraft.



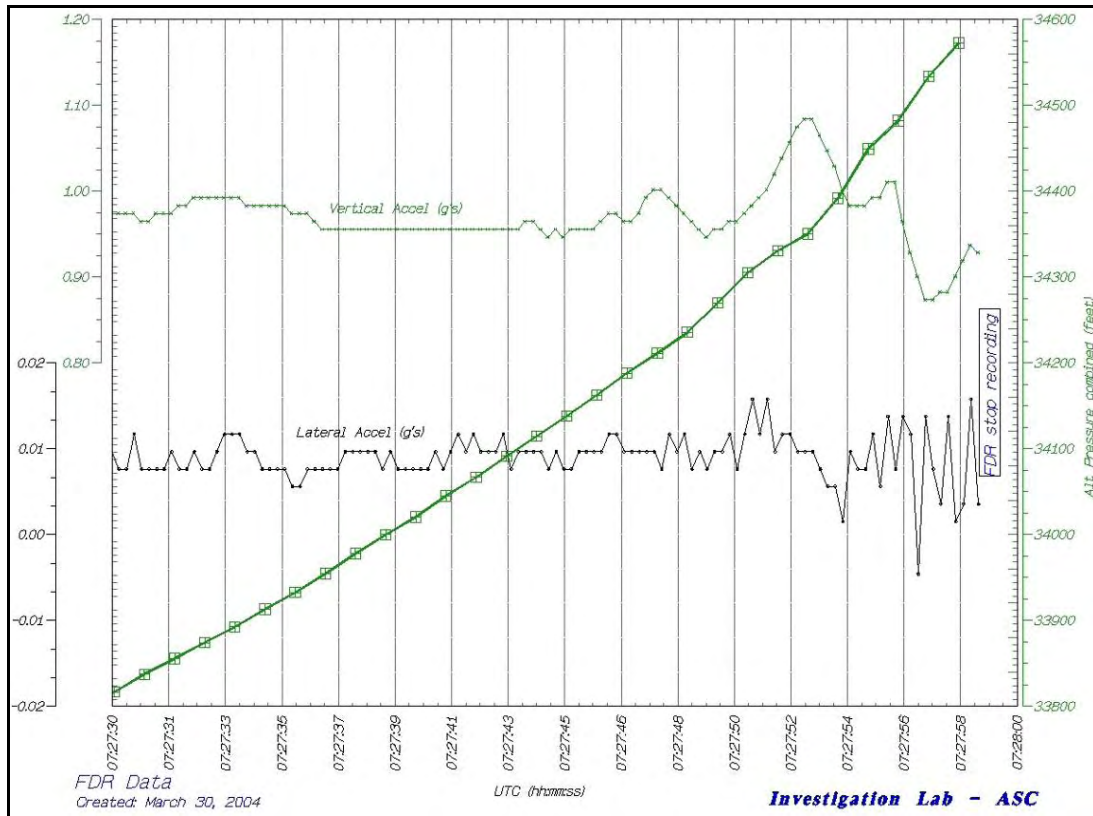

Figure 2.1-1 CI611 vertical and lateral acceleration data (last 30 seconds)

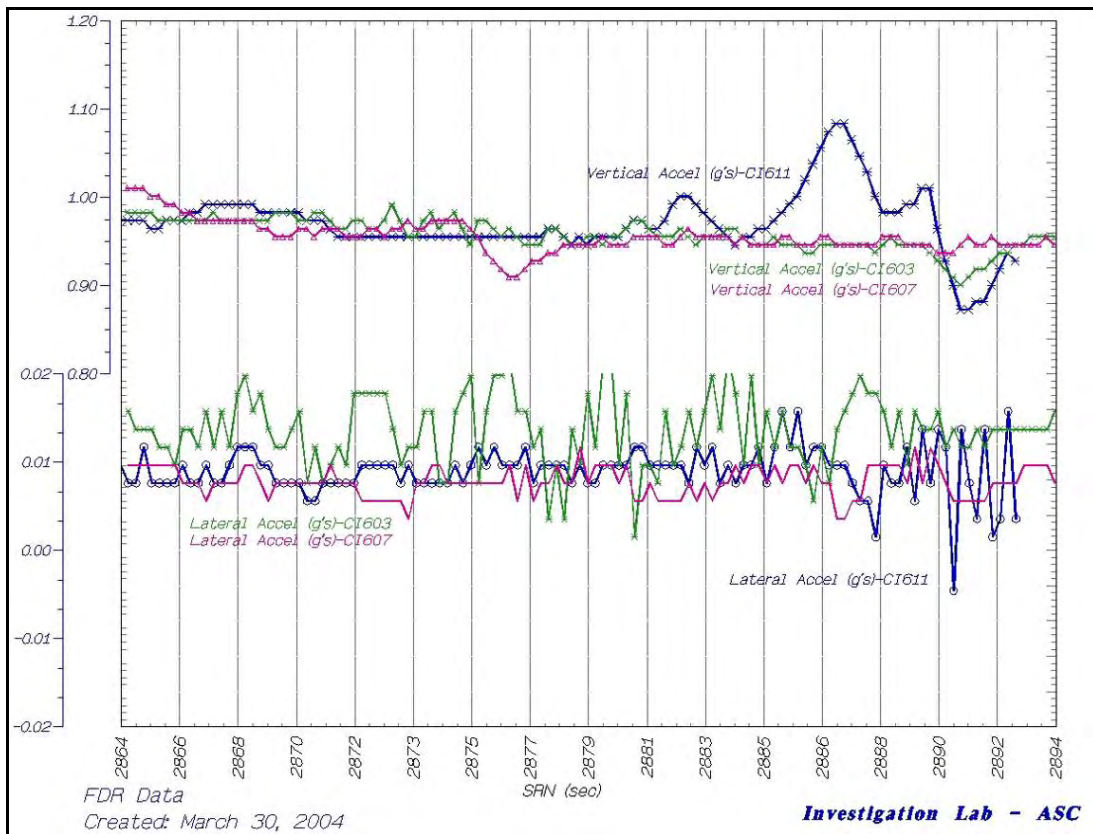

Figure 2.1-2 Vertical and lateral acceleration data comparison

## **2.2 Analysis of the Structural Failure**

In this section, the Safety Council highlights what it believes establishes the most probable scenario of the in-flight breakup of CI611. The Safety Council concludes that the breakup was highly likely due to a structural failure in the aft lower lobe section of the accident aircraft, specifically in section 46. Because a large portion of section 46 wreckage was not found, the Safety Council can not draw a definitive conclusion of the source of the structural failure. However, the Safety Council believes that it is highly probable that the structural failure of the accident aircraft was initiated at S49L and STA 2100, where fatigue cracks were found during the detailed examination of wreckage piece item 640, which was related to the 1980 repair following a tail strike incident involving this aircraft. The support for this belief is examined in the subsequent sections.

### **2.2.1 Power Loss of Flight Recorders**

At 1527:59, the CVR and FDR stopped recording. The last SSR return received by Makung radar was at 1528:03, four seconds after the flight recorders stopped recording. The last SSR return received by Xiamen SSR radar of Mainland China was at 1528:14 (three additional Mode-C data returns were received), 15 seconds after the FDR and CVR stopped recording<sup>26</sup>. The first detected PSR target for the breakup of the aircraft was at 1528:08; the PSR antenna rotation time interval is 10 to 12 seconds, indicating that the aircraft's initial breakup occurred between 1527:59 and 1528:08.

The CVR and FDR were installed on the rack E8 near the rear of the pressurized cabin. The power wire routings for the FDR and CVR were from the panel P6 in the cockpit to rack E8 in the rear cabin, and went through the compartments above the ceiling of the pressurized Sections 41, 42, 44 and 46. Because the power of the CVR and FDR were cut-off simultaneously as indicated in 2.6.1, there is a great possibility that the breakup occurred in the pressurized sections

---

<sup>26</sup> There were two transponder antennas installed on the accident aircraft, one on the top of the fuselage located about station 530, and another on the belly of the fuselage located about station 570; both were located behind door 1. The transponder can not transmit from both antennas simultaneously. It monitors the signal strength from both antennas and transmits its reply using the antenna with the stronger signal strength. If the aircraft enters a banked turn, it is possible that the fuselage could blank out one of the antennas. That could explain why the Makung radar did not receive the last signals that were received by the Xiamen radar.

of the cabin that caused the wires to break and then both recorders stopped recording.

The main power source for the CVR and FDR was the Essential AC bus, which normally was from AC bus no.4. If the generator no.4 failed, the Essential AC bus would still have power from the Sync bus without manual switching. Therefore any other single failure or breakup outside the pressurized sections of the fuselage would not cause both recorders to stop at the same time. The Safety Council believes that the simultaneous power cut-off of the CVR and FDR was most likely attributed by the structural breakup in the pressurized sections of the fuselage.

In addition, both recorders were located in the aft portion of the aircraft (above ceiling near to door 5L) and both transponder antennas were installed behind door 1 (Figure 2.2-1). The power of the CVR and FDR was interrupted simultaneously at 1527:59. However, the radar transponder continued to transmit for about 15 seconds longer. Therefore, the breakup should occur between the power plants and the recorders.

The Aviation Safety Council concludes that the loss of power to the CVR and FDR was the result of damage to electrical wires in the aft-pressurized fuselage area as the aircraft began to breakup. The forward portion of the aircraft continued to have power to the Mode-C transponder system for about an additional 15 seconds, before power to the transponder was interrupted.

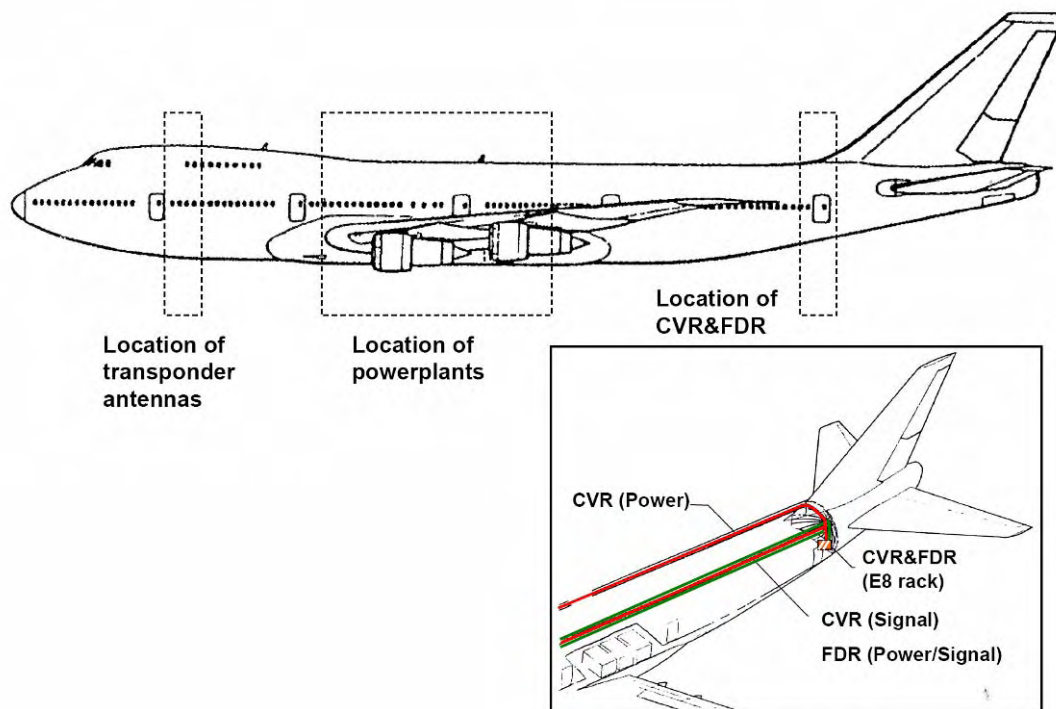

Figure 2.2-1 Locations of flight recorders, transponder antennas, and power plants

## 2.2.2 Dado Panels

Dado vent modules are installed in the lower portion of the passenger cabin sidewalls just above the floor at selected locations throughout the aircraft. The vent box modules incorporate a dado panel and a louvered air grille as part of a hinged and spring-loaded door. In normal operation, the hinged door is held in the closed position by an over-centered valve mechanism. In the event of a rapid decompression originating in the lower lobe, the differential pressure between the main deck and lower lobe will trip the valve and the hinged door will swing open into the sidewall to provide additional venting to prevent structural collapse of the floor. Once open, the hinged door will remain in the open position until each individual door is manually reset.

Nineteen out of 65 installed dado panels were recovered. The position of seven of the recovered panels could not be determined. Of the remaining 12 recovered panels, 8 were from the forward section of the aircraft (zones B, and C), and were found to be in the “closed” position. The other four (two from zone D and two from zone E) were found in the “open” position. The recovered dado panels suggest that the aircraft experienced a rapid decompression in the aft lower lobe area and the dado panels in this area opened to balance the lower pressure in

the lower lobe.

### 2.2.3 CVR Signatures

From the CVR recording, the conversation in the cockpit appeared normal. However, the last 130 milliseconds of CVR recording contained a unique sound signature.

Based on different sound wave propagating speed via air and via the aircraft structure, the travel time of the sound wave from an event source via air or aircraft structure to reach a specific point on the aircraft are different, such time difference can be referred to as the precursor in the CVR recording. When the event source is away from cockpit, the arrival time of precursor to the CAM is always ahead of the event sound because the sound wave propagating speed in metal is much faster than in the air. Figure 2.2-2 shows the C1611 CVR recorded precursor and event sound signatures. By comparing both signatures can provide the possible propagation path of event sound.

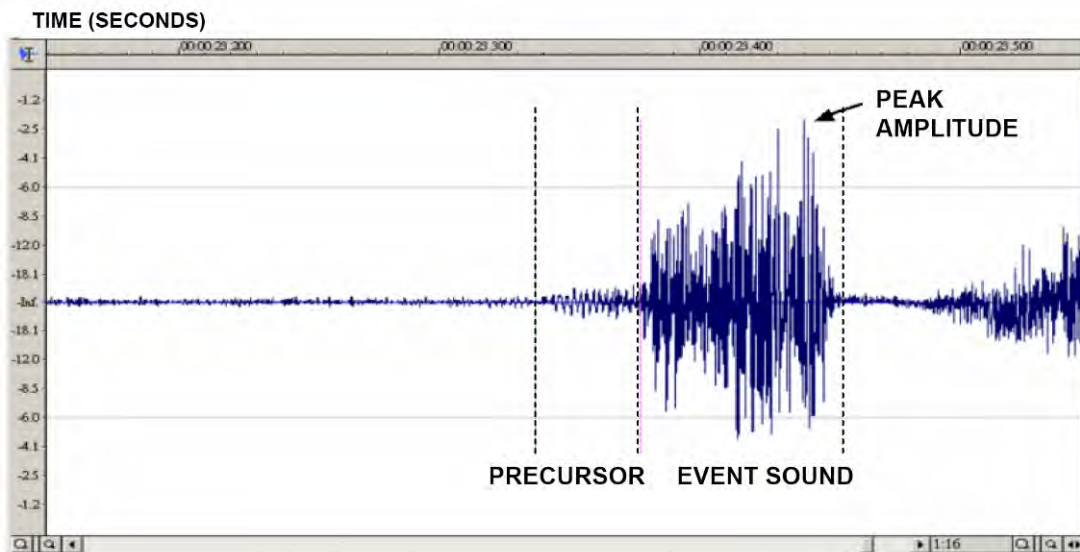

Figure 2.2-2 Typical precursor and event sound signatures

As the sound propagates, the propagation media would affect the magnitude of precursor and event sound differently. When the event sound propagated through fuselage, the fuselage structure will greatly attenuate the sound wave energy and the magnitude of the event sound sensed by CAM would be much less than the sound propagated only via air. In other words, if the breakup is occurred in the non-pressurized area, the fuselage structure will behave like a

sound insulator that reduces the magnitude of the sound wave to the CAM; therefore, the event sound level would be less than the precursor level. In the case of CI611, the event sound level is much higher than the precursor sound level. Based on these assumptions, the Safety Council concludes that the structural breakup of the accident aircraft was most likely occurred in the pressurized area. The detail CVR sound spectrum analysis is in section 2.6.

## 2.2.4 Wreckage Distribution and Examination

Figure 2.2-3 shows the relative locations of the CI611 wreckage. The wreckage distribution pattern matches the four groups of aircraft wreckage detected by PSR.

The wreckage distribution data show that the distance between the tail (section 48 with lower portion of fin) and forward portion of fuselage (section 41-44) was 1.5 nautical miles. The distance between the tail and most eastbound wreckage (section 46), which was recovered under water, was 3 nautical miles.

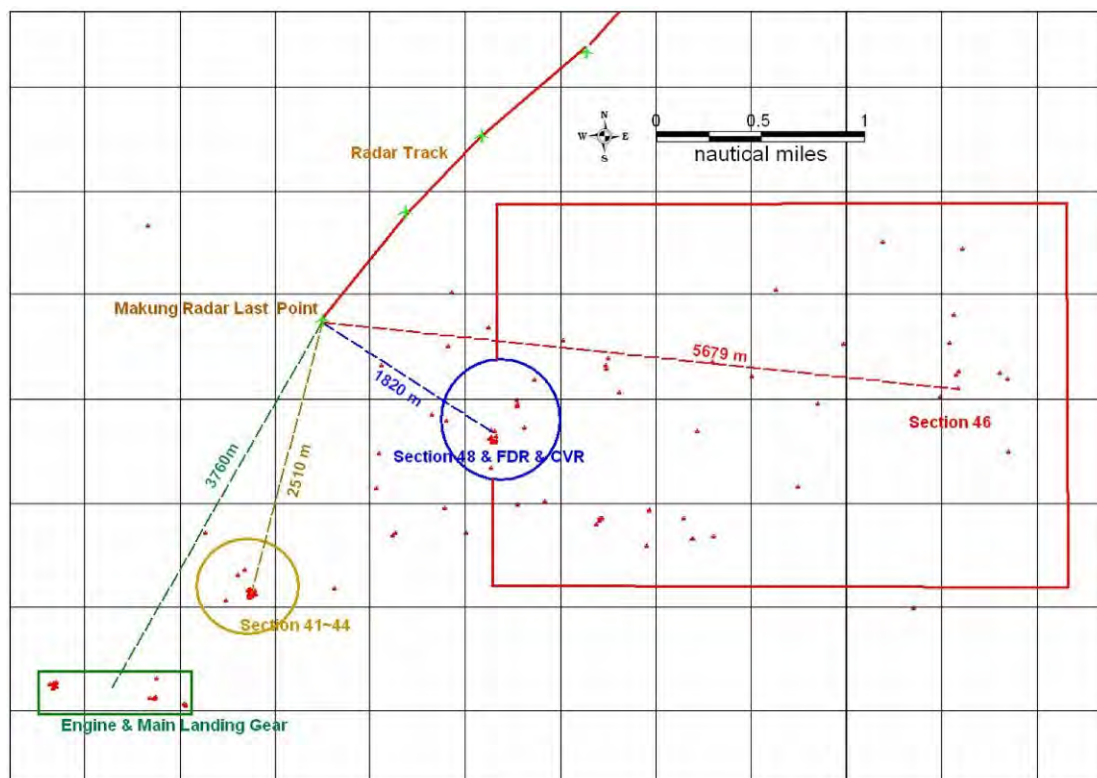

Figure 2.2-3 Relative location of the wreckage

The wreckage distribution can also be plotted along the flight path from Taipei to

Hong Kong, which is shown in Figure 2.2-4. One can readily see that the wreckage pieces from the cockpit, engines, wings, all landing gears, and sections 41, 42, and 44 are distributed along a very concentrated segment while section 46, 48, and the tail empennage are spread widely.

The figure also shows a step jump from the forward portion of the aircraft to the aft sections. It shows that the fuselage section 46/48 structure aft of the aft wheel well bulkhead at STA 1480 was separated from the rest of the aircraft.

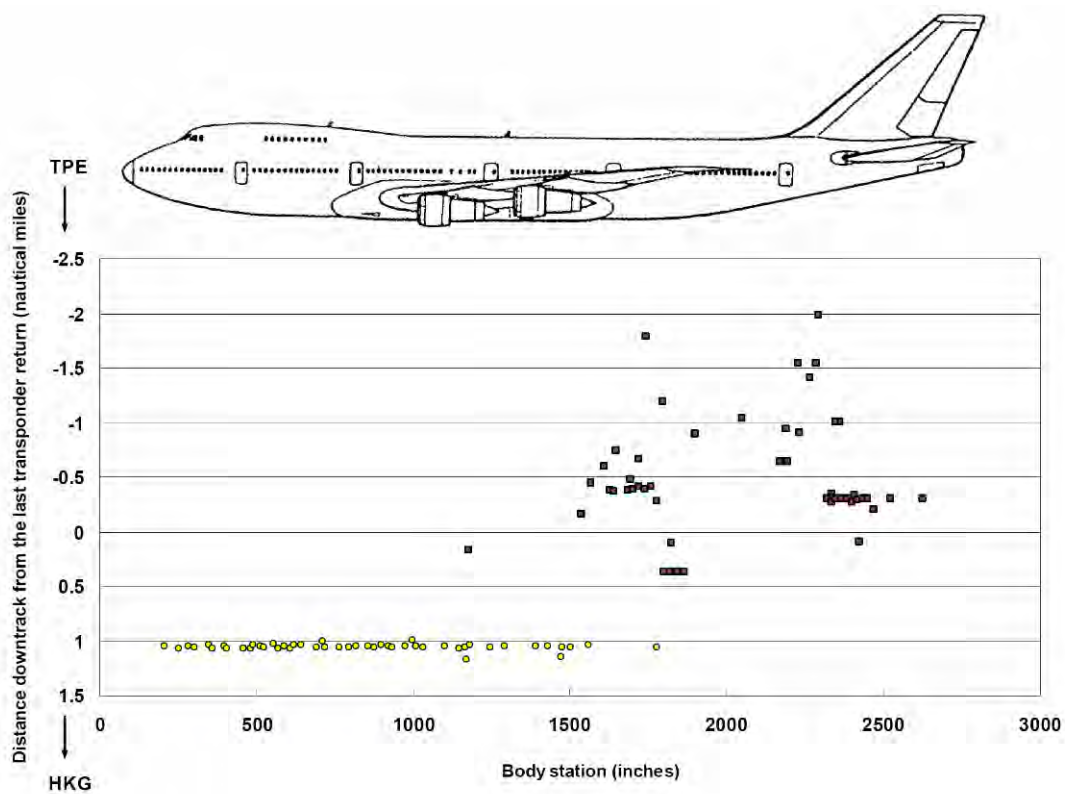

Figure 2.2-4 Wreckage distributions along the flight path

Examination of the empennage and aft fuselage revealed that the middle portion of leading edge of the vertical fin sustained a heavy impact from debris from the right hand side of fuselage that likely was associated with the upper portion of the vertical fin separating. Some stringer fragments of section 46 were found stuck in the right side of vertical fin. The lower portion of the fin (item 630C1), the upper portion of the fin (item 2035), and several of the floating pieces (item 22) show similar evidence of impact damage on the right side. The entire empennage separated from section 46 at STA 2360 resulting from a combination of impact by fuselage debris and insufficient remaining structure of section 46 to support the weight and loads of the empennage.

The fuselage and wing structure forward of section 46 were distributed in one major debris field. Due to the close proximity of the items that were recovered within the major debris field, it can be concluded that the forward fuselage and wings were still connected to each other at the time of water impact. Examination of the condition of the recovered wing center section shows that the wing structure was essentially intact at the time of water impact and both wings impacted the water in approximately a normal attitude.

All four engines were recovered one nautical mile to the southwest of the major debris field, indicating that they separated from the wings at altitude as also supported by the ballistic analysis in section 2.9. Examination of the four engines indicated that they were not producing power at the time of water impact.

Base on the above information, the Safety Council concludes that the initial breakup of the aircraft was from the aft section of the fuselage.

### **2.2.5 RAP Preparation Data Collection during 6C Check**

In November 2001, CAL performed a structure patch survey to collect the data for B-18255 RAP, and the following photo was taken as shown in Figures 2.2-5.

The photograph was taken from underneath the aircraft looking up towards the fuselage. This area of the aircraft belly slopes upward towards the rear of the aircraft. When the aircraft is parked, the forward end of the doubler is closer to the ground than the aft end. There were several traces observed on the doubler and the skin around STA 2100. Traces 1, 2, and 3 are brown in color and straight toward the aft of the aircraft, suggesting that the traces were induced by the relative wind during flight. Trace 4 shows several curved lines of transparent condensate liquid that flowed from STA 2090 toward the forward (lower) end of the doubler, consistent with flow due to gravity when the aircraft was parked. The traces seen in the November 2001 photographs were not evident on the wreckage when it was recovered.



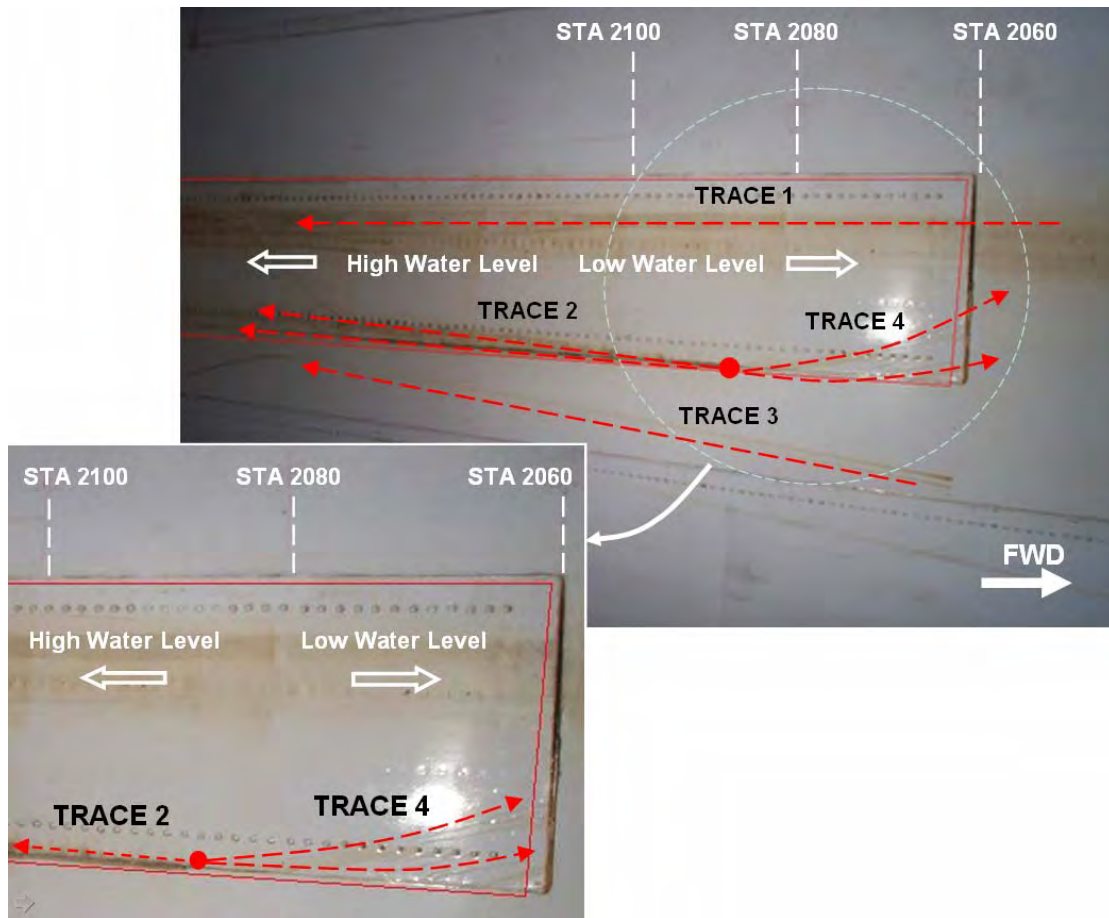

Figure 2.2-5 Comparison of Trace 1,2,3 (straight line) and 4 (curve)

Traces 2 and 4 began at the same origin but went in different directions. It suggests that trace 2 occurred as the aircraft was in the air, but trace 4 occurred when the aircraft was on the ground. The darkness of the traces shows the accumulated time and quantity of the flow. The color of trace 2 is the darker, which suggests a larger quantity of flow escaped into the air stream in flight.

This phenomenon, discovered during the accident investigation upon examination of photographs of the 1980 repair doubler, showed that there was possibility hidden skin damage beneath the doubler in the vicinity of STA 2100, at the time when the photographs were taken.

## 2.2.6 Examination and Structural Analysis of Item 640

Evidence of fatigue crack was found and confirmed by both CSIST and BMT on the piece of wreckage identified as Item 640 (section 1.16). There was a cumulative length of 25.4 inches, including a 15.1-inch continuous fatigue crack

and other smaller fatigue cracks aft and forward extending from hole +14 to hole 51. (Figure 1.16-12 and 1.16-13).

Based on the findings from CSIST and BMT, the Safety Council examined the origin of the fatigue cracks and the length of the existing continuous crack in the skin prior to the in-flight breakup in this subsection.

### 2.2.6.1 Origin and Pattern of the Fatigue Crack

Photographs of the item 640 skin show that many longitudinal scratches (fore to aft) existed on the faying surface of the skin. An attempt to blend out of these scratches was also apparent from the rework sanding marks found on the repaired surfaces. Those scratches and sanding marks were consistent with the 1980 tail strike event of the accident aircraft.

The scratches caused discontinuity of the skin and stress concentration termed “stress risers.” The laboratory observations showed that the main fatigue crack and most of the MSD aft and forward were initiated from the scratches that existed at or just beyond the peripheral row of fasteners common to the repair doubler. Figure 2.2-6 shows the longitudinal scratch on the faying surface of the skin near hole 20 where fatigue crack initiation occurred from multiple origins.

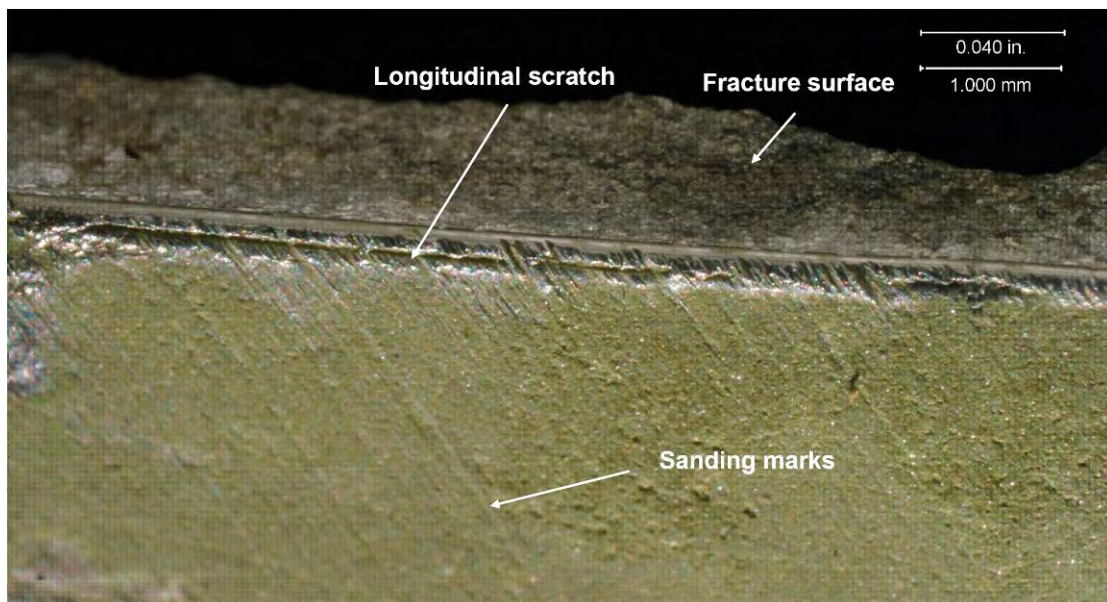

Figure 2.2-6 Fatigue crack originated from the scratch near hole 20

The fatigue crack pattern of Item 640 differs from traditional crack patterns. The standard cracking configuration assumes those cracks grow forward and/or aft

from hole to hole. But the crack configuration of Item 640 identified in the laboratories does not show any evidence of forward-aft striations within the flat-fracture fatigue areas. Instead, the crack growth pattern on Item 640 shows an increasing growth rate through thickness (Figure 2.2-7). This can be attributed to the cracks growing from many origins on the skin surface at the scratch locations and propagating inward. While the number of cycles required for the cracks to propagate through the skin thickness was determined as indicated in the BMT report, it was not possible to determine when in the aircraft history these particular cycles occurred. Thus, it was not possible to determine when the crack first penetrated the entire skin thickness.

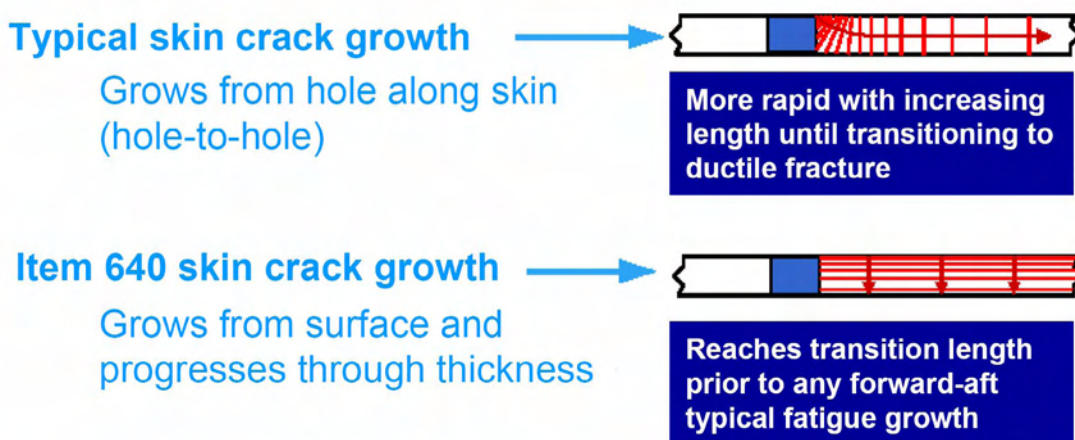

Figure 2.2-7 Cracking on Item 640 differs from typical fatigue crack

### 2.2.6.2 The Existing Crack prior to the Breakup

According to the BMT report, numerous areas of the overhanging portion of the faying surface of the doubler exhibited signs of localized fretting damage above the S-49L fracture surface. The furthest forward and aft portions of this localized damage was observed at hole +16 (~STA 2061) to hole 49 (~STA2132) with the most significant degree present between hole 8 and hole 43 (centered with hole 18 at STA2100). Low power optical examination suggested the damages were resulted from hoop-wise movement of the skin against the doubler.

The existing crack in the skin under the repair doubler would open cyclically with the pressurization of the aircraft. The repetitive opening of the crack would cause relative hoop-wise movements between the mating fractured skin (which was not recovered) and the repair doubler, therefore resulted in the rubbing (fretting) of the contact surfaces (Figure 2.2-8). The fretting damage on the overhanging

portion of the repair doubler was consistent with this phenomenon (Figure 1.16-8).

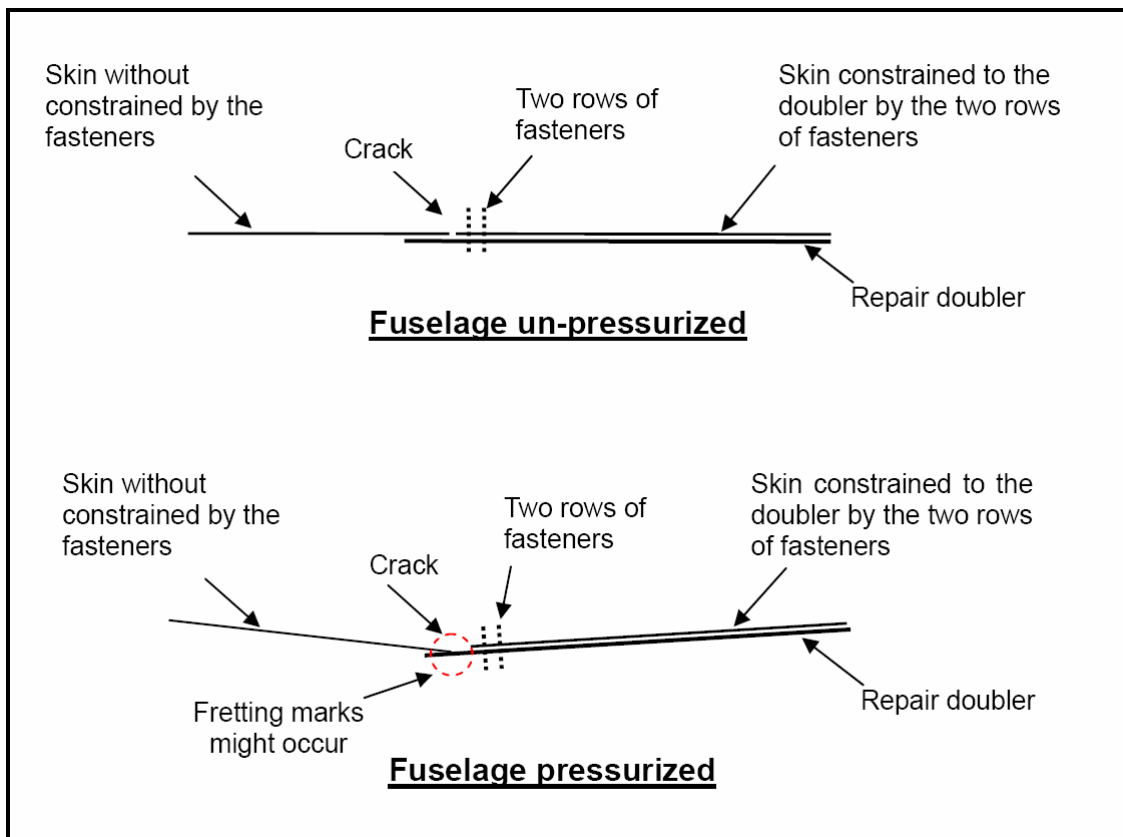

Figure 2.2-8 The fretting marks caused by the pressurization cycles

Fretting marks were more pronounced near the main fatigue crack area and less pronounced at both ends of the crack. This pattern is consistent with the theory that the fretting marks were caused by the repetitive opening of the crack. Most of the fretting damage is located adjacent to fastener locations, where rivets held the skin and doubler in direct contact.

As shown in section 1.16.3.2, two cross-sections of the fretting damage near hole 32 were chosen to characterize the area of contact. The results show that the scratches, which were caused by the hoop-wise movement between the skin and repair doubler, were superimposed by some material. This phenomenon indicated that after the earlier hoop-wise movement that created scratches on the repair doubler, the later repetitive movement probably moved the materials close to the scratches and covered the scratches. In addition, different colors in the areas of contact also indicated that the fretting marks were probably associated with different degree of rubbing during different period of time.

Therefore, the Safety Council believes that the fretting damage is most likely to be the result of repetitive crack opening/closure during pressure cycle. Once the unstable and rapid rupture of the cracking occurred, there would be no chance for the crack to close again and therefore leave the fretting damage as observed. Although the ASC could not determine the length of cracking prior to the accident flight, from the distribution of the fretting marks from STA 2061 (near the edge of the repair doubler) to STA 2132, suggests that there would be a continuous crack of at least 71 inches in length before the breakup of the aircraft.

Another evidence of the pre-existing crack was proposed in the BMT report. The BMT report proposed that there were stable extensions of fatigue progression in areas outside of the main fatigue crack and referred to this phenomenon as “quasi-stable crack growth”. The explanation of the quasi-stable crack growth in the BMT report were as follows:

1. The presence of regularly spaced marks on the fracture surface.

The regular spacing of these marks as shown in Figure 2.2-9, is consistent with the application of constant magnitude stress cycles, or the pressurization cycles (once per flight cycle). These marks are more closely spaced near the flat-fracture fatigue area than away from the main fatigue area. These incremental crack growth indications were observed as far forward as approximately STA 2055 (outside the covert of the repair doubler) and as far aft as STA 2140 (hole 56).

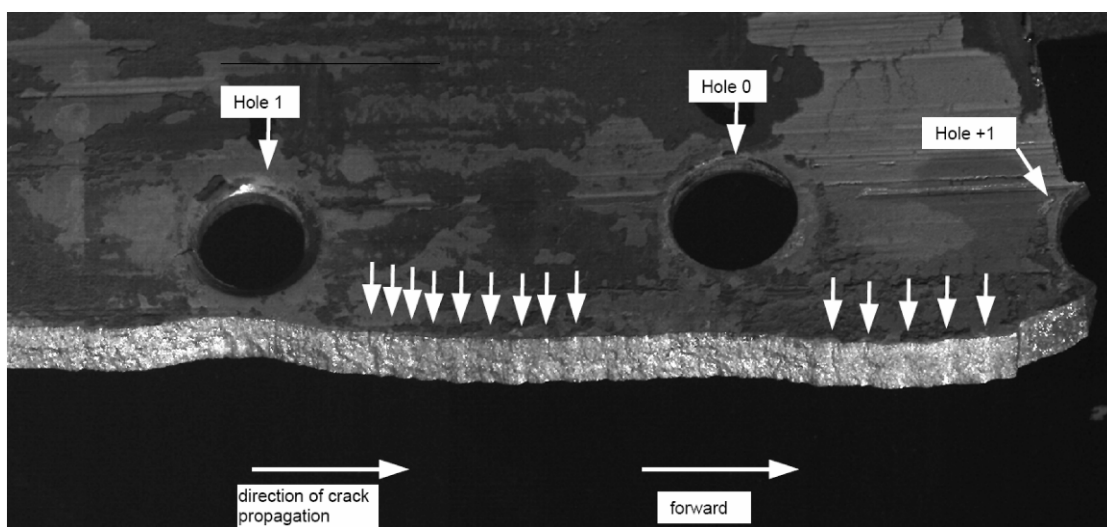

Figure 2.2-9 The regular spacing of cracking increments found on Item 640

2. Compressive deformation of the aluminum cladding along the edge of the fracture common to the faying surface.

Cyclic rubbing of the fracture surface and associated compressive deformation of the cladding was observed along the faying surface shown in Figure 2.2-10 providing additional evidence of pre-existing crack. The cladding displayed compressive deformation due to cyclic crack closure as far forward as hole +17 and as far aft as hole 62. The remaining fracture aft of hole 62 displayed “necking”, which is typical of continuous tensile loading to ultimate tensile separation (Figure 2.2-11).

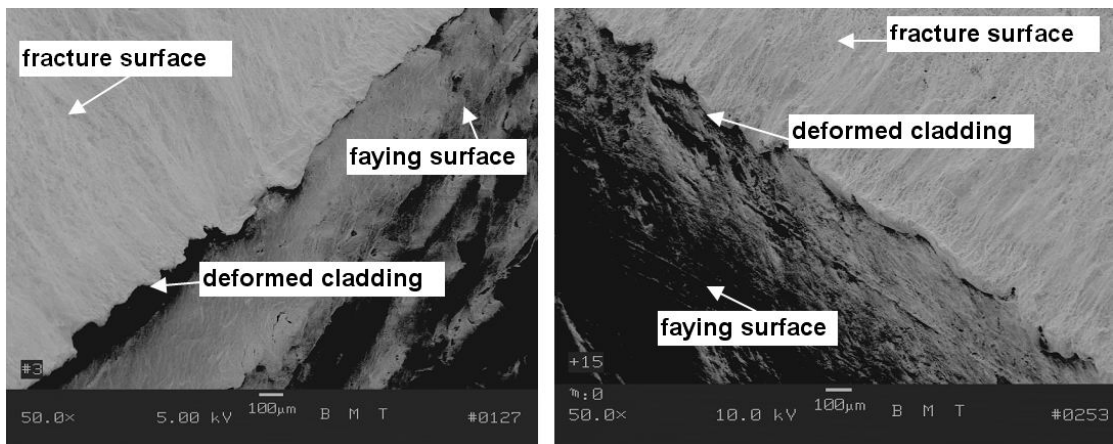

Figure 2.2-10 SEM photographs of the cladding near hole 3 (left) and +15 (right)

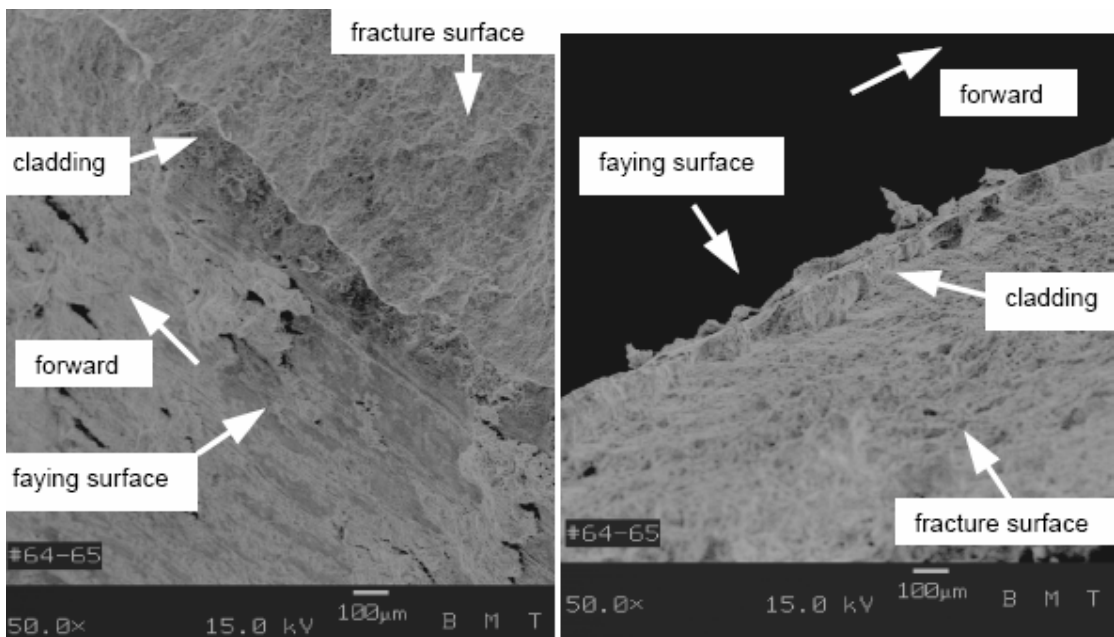

Figure 2.2-11 SEM photographs of the cladding between hole 64 and 65

According to these observations, the BMT report suggested a pre-existing crack in the skin continuously from STA 2055 to 2146, or approximately 93 inches in length prior to the in-flight breakup. The diagram of different length of crack was shown in Figure 2.2-12.

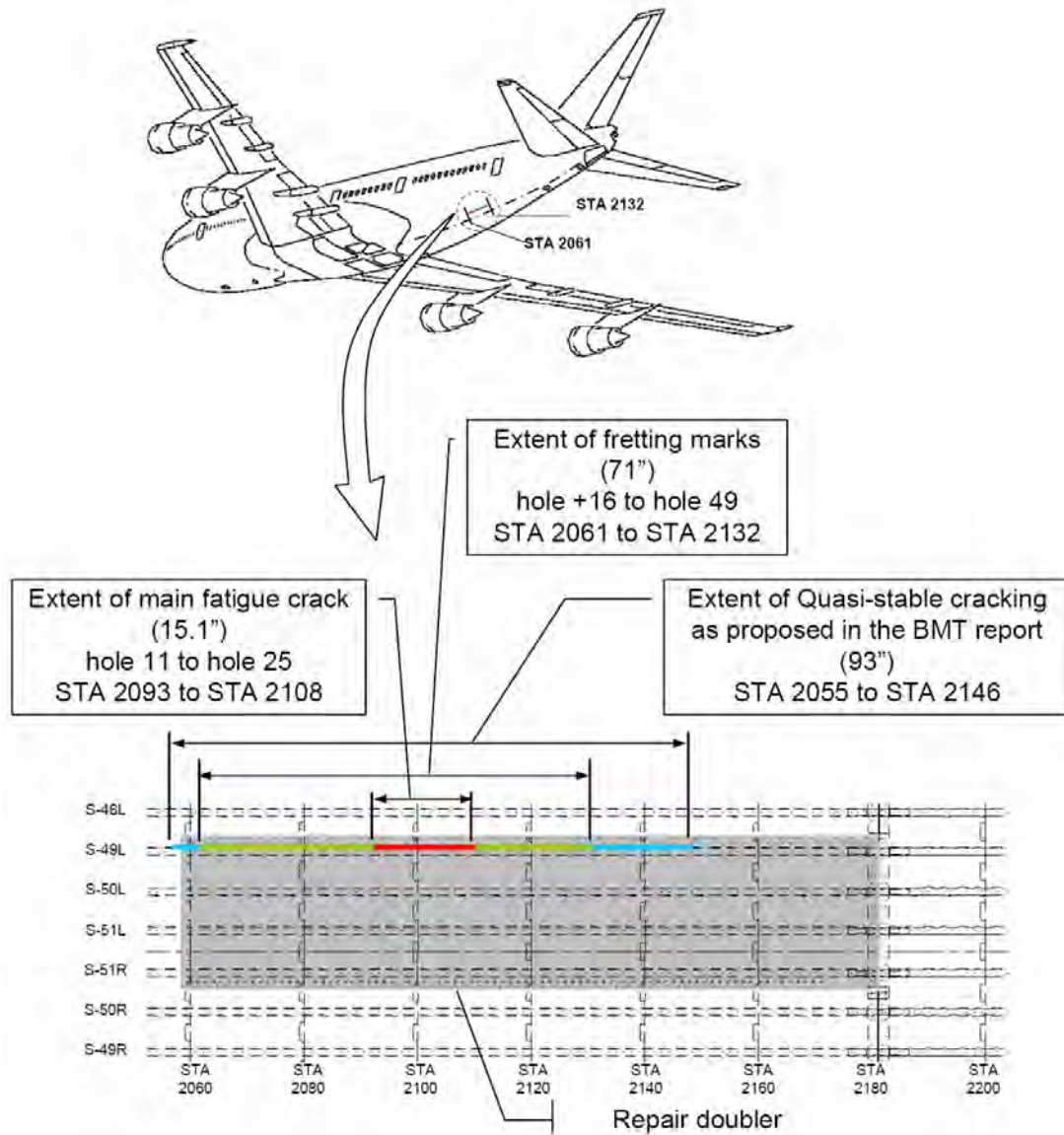

Figure 2.2-12 Different signs of cracks

Although the fretting marks, regularly spaced marks, and deformed cladding may be caused by some other unknown factors, such as post-accident damage to the fracture surface, but the chance was relatively small. The Safety Council believes that all these indications mentioned above were most likely caused by the repetitive opening and closure of the pre-existing crack, and the length of the crack before the aircraft in-flight breakup was at least 71 inches.

From the residual strength analysis discussed in section 2.5, when the crack was over 58 inches, the residual strength of the skin assembly would go below the operating stress (Figure 2.2-13), therefore caused the skin assembly beyond the capability limit under the application of normal operational loads.

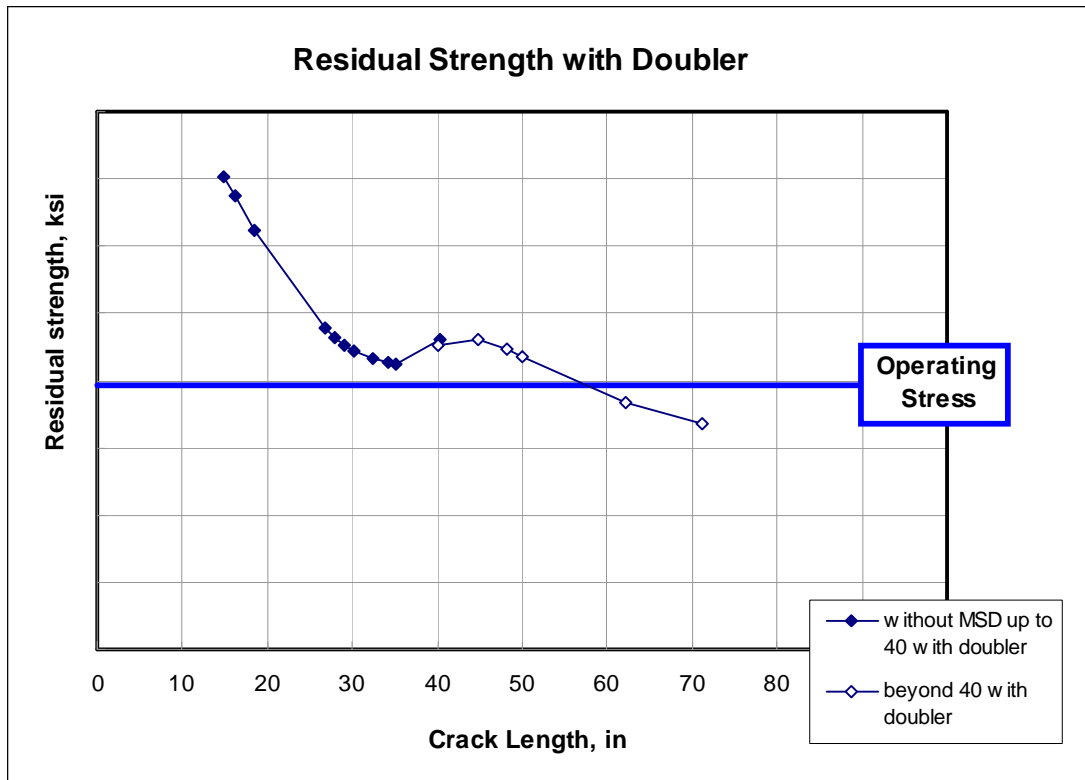

Figure 2.2-13 Residual strength of cracking

## 2.2.7 Fracture Propagation

Figure 2.2-14 shows the direction of the crack propagation on each piece of the wreckage in section 46. The methodology used to determine the direction of the cracking is described in Appendix 18. Once a portion of the structure failed, it could no longer sustain the integrity of the entire fuselage structure. The propagation pattern of the fracture is highly nonlinear and extremely dynamic. Without the recovery of all the wreckage pieces, it was nearly impossible to draw a conclusive break-up sequence of the aircraft. Therefore, the following observation only provides one possibility for the cracking to link together accordingly and formed a possible propagating sequence.



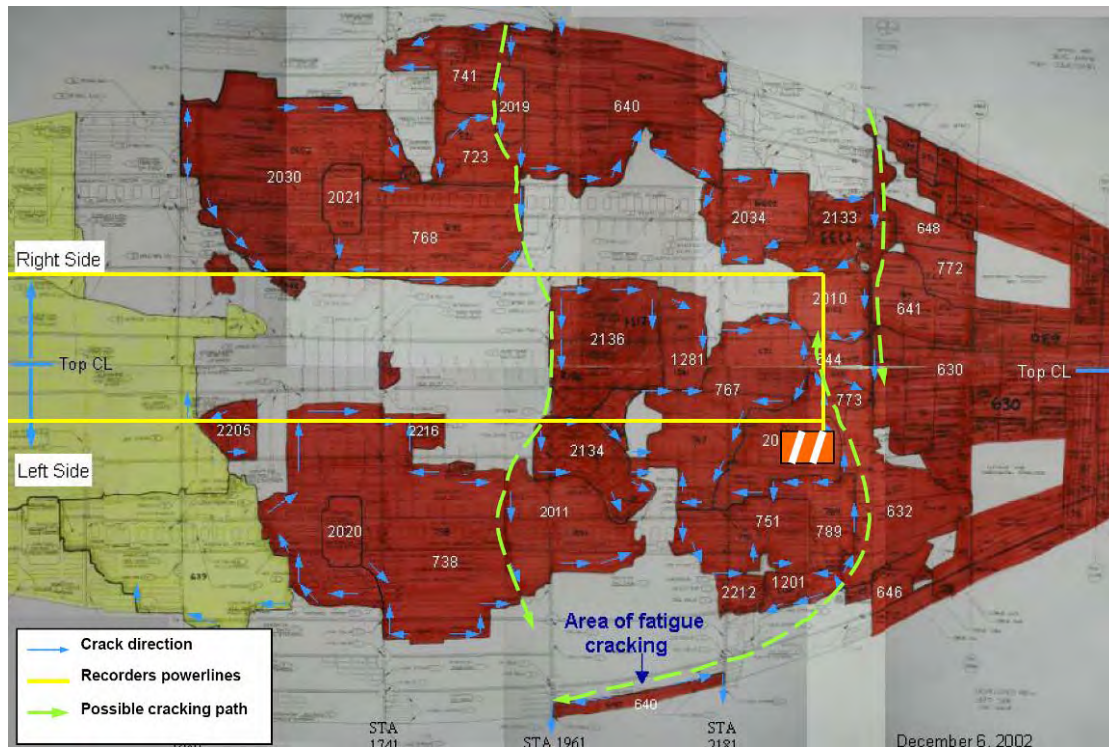

Figure 2.2-14 Directions of fracture propagation

## 2.2.8 Summary

Based on the above analyses, the Safety Council concludes that the most probable scenario of the CI611 in-flight breakup is as follows.

Examination of wreckage item 640 skin shows that many longitudinal scratches (fore to aft) existed on the faying surface of the skin. An attempt to blend out of these scratches was also apparent from the rework sanding marks. Those scratches and sanding marks were related to the 1980 tail strike event of the accident aircraft.

Fatigue cracks were found on wreckage Item 640. There was a cumulative length of approximately 25.4 inches, including a 15.1-inch fatigue crack and other smaller fatigue cracks aft and forward extending from hole +14 to hole 51. The fatigue crack pattern shows an increasing growth rate through thickness and propagating inward. This can be attributed to the cracks growing from many origins on the skin surface at the scratch locations.

The increasing differential pressure as the accident aircraft climbed and approached to its designated cruising altitude 35,000 feet, enabled the

pre-existing cracks, centered about STA 2100 and S-49L, to reach the length that reduced the residual strength to its operating limits, and resulted in an unstable separation, along with a rapid loss of cabin pressure.

The fracture progressed towards the upper skin and severed the power wiring to the CVR and FDR, before any significant anomaly could be recorded.

Pieces of wreckage from section 46 began separating on either side of the fuselage. The separating debris from the right side of the belly struck the vertical fin as evidenced by a section of stringers found stuck inside the fin. Once the structural integrity of the remaining portion of section 46 could no longer support the loads, the entire empennage separated from the aircraft.

During the breakup process, the abrupt change in aerodynamic characteristics would likely have resulted in significant inertial forces that led to the separation of the engines at altitude. All four engines separated from the main fuselage almost simultaneously as evidence by the close proximity of their locations in the debris field.

The remaining portion of the aircraft (the forward fuselage and attached wings) was intact and hit the water in a relatively flat attitude. Severe impact with the water caused additional severe damage to these components.

## **2.3 The 1980 Tail Strike Repair**

This section describes the occurrence and the repairs to the 1980 tail strike of the accident aircraft. The roles of the operator, the manufacturer's field service representative (FSR), and the civil aviation authority related to the repair are discussed.

### **2.3.1 The Occurrence in 1980 and its Subsequent Repairs**

Aircraft B-18255 (then registered as B-1866) had a tail strike occurrence at Hong Kong Kai Tai International Airport on February 7, 1980. According to the records provided by Boeing, the Boeing Representative in Hong Kong assisted CAL with the initial inspection of the damage in Hong Kong. The aircraft was ferried back to Taiwan un-pressurized on the same day and was back in service on February 8, 1980, after completion of a temporary repair.

The Safety Council was unable to locate any maintenance records that described the temporary repair of the damaged area of the aircraft. The B-18255 aircraft logbook had no record of any repair or maintenance work done after the aircraft was ferried back to Taiwan. However, according to interview records, the temporary repair was completed overnight immediately upon arrival on February 7, 1980, in accordance with the ERE.

According to the aircraft log book, B-18255 was grounded for "fuselage bottom repair" from May 23 to May 26, 1980. The major repair and overhaul record dated May 25, 1980, in the logbook indicated that aft-belly skin scratch repair was performed on B-18255, including:

1. Peel area cut out & trim;
2. Patched with doubler; and
3. Accomplished after belly skin repair in accordance with CAL engineering recommendation and Boeing SRM 53-30-03 fig. 1.

#### **2.3.1.1 Wreckage Examination of the Repaired Area**

After examining wreckage items 640 and 630, the Safety Council concludes that the May 1980 repair to the tail strike damage area of the accident aircraft was

not accomplished in accordance with the Boeing SRM. Specifically, the Boeing SRM allows scratches in the damaged skin within allowable limits<sup>27</sup> to be blended out. If, however, the damage was too severe and beyond allowable limits, the damaged skin had to be cut off and a doubler was to be installed, or the old skin was to be replaced with piece of new skin. The damaged skin of B-18255 was beyond the allowable limit and scratches remained on the skin.

When the belly section of the recovered wreckage in both Sections 46 and 48 were examined, there were three repair doublers, one in Section 46, and two in Section 48. A fourth repair doubler located just aft of the item 640 doubler is visible in the photographs taken November 2001. The section of fuselage skin containing this fourth doubler was not recovered. The two doublers in section 48 were in the un-pressurized area as described in 1.12.4. After removing the doublers, the Safety Council found scratch patterns on the skin covered by the repair doublers that were comparable to the skin around STA 2100. The skin underneath repair doubler-2 had been cut off. The record shows that scratch marks in both sections 46 and 48 occurred as the result of the 1980 tail strike. However, no additional records can be found regarding the two repair doublers in Section 48 (the November 2001 RAP data collection only covered the pressurized area of the fuselage), the Safety Council was unable to determine when the two Section 48 doublers were installed.

### **2.3.1.2 Damage Assessment of the Structural Repair**

The 1976 version of Boeing SRM 53-30-01 Figure 1 provided allowable damage to the aircraft fuselage skin. After clean up of the damaged area, the distance of the damage from an existing hole, fasteners or skin edge must not be less than 20 times depth of clean up. The remaining skin must be no less than 85% of its original thickness when the length of the damage is longer than 11 inches; otherwise the damaged area must be replaced or repaired per SRM 53-30-03 to restore the structure strength. According to interview and maintenance records, after consulting with the Boeing Representative for CAL in Taipei, CAL engineering department issued an Engineering Recommendation for the damage repair on February 8, 1980. The Engineering Recommendation specified that a permanent repair be made to the aircraft in accordance with the

---

<sup>27</sup> See 1.6.1.3 for fuselage skin allowable damage.

Boeing 747 SRM within four months. This meant that the damaged area had to be cut out before the application of a doubler or the piece of damaged skin was to be replaced.

Due to the lack of detailed maintenance records for both the temporary and permanent repairs in 1980, the Safety Council was unable to determine how the repairs were actually conducted. Therefore, the analysis of the repair planning and workmanship is based primarily on the results of the wreckage examination.

Examination of wreckage item 640 indicated that the maximum depth of scratches after the clean up was about 13.5% (0.0096 inch) of the skin thickness and the length of the scratches on the damaged skin was more than 20 inches. In addition, several scratches passed directly through fastener locations. The damage was beyond the allowable damage specified by the SRM. Repairs could be made by replacing the entire affected skin or cutting out the damaged portion and installing a reinforcing doubler to restore the structural strength. Instead either of these acceptable options, a doubler was installed over the scratched skin. In addition, the external doubler did not effectively cover the entire damaged area as scratches were found at and outside the outer row of fasteners securing the doubler. When the doubler was installed with some scratches outside the rivets, there was no protection against the propagation of a concealed crack in the area between the rivets and the perimeter of the doubler.

Based on observations of the wreckage, the Safety Council concludes that the maintenance methods and procedures regarding the repairs to the damaged area of B-18255 did not comply with the content of the SRM. As a result, since the 1980 repair, the accident aircraft had been operated with an inadequate repair and subsequent deterioration was not detected during routine maintenance and other inspections.

Further, as indicated in 1.12.4, there were two repair doublers installed on the skin of the section 48 with similar scratch patterns. Although those two doublers were not in the pressurized area, it nevertheless involves the primary structure for the support of the empennage. It should also have followed the SRM 53-30-03, which specifies that scratches should have been removed before the doublers were applied.

### **2.3.2 The Manufacturer's Role**

CAL personnel indicated that, for minor repair, it was not necessary to inform the Boeing FSR because it would simply follow the SRM procedure to complete the repairs. CAL also indicated that it was not necessary to keep the relevant maintenance records for minor repairs. According to interview of the CAL Boeing FSR at the time of the 1980 tail strike (retired), the FSR stated that if the repair was to be conducted in accordance with the SRM, then it was not necessary for CAL to inform the Boeing FSR regarding the repair. CAL would inform the Boeing FSR only if there were a problem or difficulty in the repairing process. Since the tail strike repair was not a complex repair, the CAL did not inform the Boeing FSR of the permanent repairs of the 1980 tail strike.

Those two interview records showed that CAL maintenance personnel, as well as the Boeing FSR are consistent in their recognition that the Boeing FSR had not been informed by the CAL during the 1980 tail strike permanent repair process.

However, when interviewed the CAL chief structural engineer (also retired), who was responsible for the 1980 tail strike repairs, he stated that for the permanent repair of the damaged area, to follow the SRM would require the skin in the damaged area to be cut out, and then a 125" x 23" re-enforcement doubler was to be applied. Since the cut out area was quite large, there would have been difficulty following the SRM repair instructions. Because of this difficulty, they decided not to follow the SRM to cut out the damaged skin; rather, they used the method similar to the temporary repair by applying a re-enforcement doubler directly onto the damaged skin. He stated that he did inform Boeing FSR of the difficulties CAL encountered and he requested the Boeing FSR to inform Boeing of the repair method and no response was received. Since CAL did not receive any response regarding the suggested permanent repair process, the CAL chief structural engineer considered that Boeing had agreed to the repair method.

Due to the lack of maintenance records of the accident aircraft, the Safety Council can not make an adequate assessment of what actually happened in communication between CAL maintenance personnel/engineers and the Boeing FSR in 1980 relevant to the permanent repairs of the tail strike. The Safety Council can only conclude that the 1980 tail strike permanent repair did not follow the SRM as already discussed in Section 2.3.1.2. Further, the Safety

Council believes that in either case, there was a problem in communication between Boeing Commercial Airplane Company and CAL.

According to a document issued by Boeing in September 1980 as stated in 1.17.2.3, the Boeing FSR is responsible for providing assistance to the customer in the resolution of problems that affect the operation of Boeing aircraft. Since the B747-200 was a relatively new aircraft in the CAL fleet at the time of the tail strike (B-18255 was the second B747-200 CAL purchased from Boeing), one can infer that the FSR's involvement would be more intense than when the type is long established in the fleet. The Safety Council believes that when a Boeing FSR knew of the damage, he/she should have had the awareness to be proactive in the provision of safety advice. If a more proactive approach had been taken, one could have expected questions to the operator about the permanent repair. There can be little doubt that the FSR would have seen the scratches on the underside of the aircraft that had suffered a recent tail strike. The opportunity to provide expert advice on a critical repair was lost, as there are no records to show that the FSR had a role in providing advice on the permanent repair.

The aircraft manufacturer had FSRs as technical advisers to provide advice and assistance to the operator. There is no doubt that the manufacturer's advisers were not to make decisions for the operator. However, they were there to provide advice, guidance and where necessary to assist in seeking advice directly from Boeing Home office. Part of the adviser's duty is to apply understanding of safety issues and to work closely with the operator. They are also expected to be proactive in problem solving.

### **2.3.3 CAL Quality Control**

Although there is no additional documentation related to the inspection procedures taken after the 1980 repair, based on the wreckage examination, the Safety Council believes that the deficiencies in quality inspection within CAL led to not detecting the ineffective repair on B-18255 in 1980. CAL 's quality assurance system for the specific repair did not detect that the repair was not performed in accordance with the SRM repair procedures.

The Safety Council believes that CAL should review and revise as necessary its inspection and quality assurance system, so that it ensures that aircraft

maintenance, overhaul, alterations and the airworthy repairs comply with relevant requirements of the Maintenance Control Manual.

#### **2.3.4 The CAA's Role**

The CAA does not have any record or documentation related to the tail strike repairs in 1980 of B-18255. CAA stated that because CAL categorized the repair to be a minor repair at that time, CAL did not file the repair with CAA. In addition, when CAL Engineering issued the ERE for B-18255 tail strike repair, the ERE shows that CAL did not inform CAA. Further, the Safety Council can not find any indication that CAA personnel had been involved with the B-18255 tail strike repair.

Interview records indicated that the CAA inspection system in 1980 was not as well established as the present system, and the inspectors had no handbook for inspection guidelines and no inspector training to carry out safety inspections at the time. Based on the limited information, the Safety Council can not determine whether the CAA was capable of overseeing the maintenance activities of CAL in 1980.



## 2.4 Maintenance Issues

This section describes the maintenance issues relevant to the investigation of the CI611 accident. Issues discussed in this section may not be directly related to the causal factors of this accident, but could be related to the risks to safe operation found during this investigation.

### 2.4.1 Structure Inspections

The recovered wreckage item 640 included a repair doubler installed between STA 2060 and 2180. The doubler was installed over the original fuselage belly skin between stringers S-49L and S-51R. Underneath the doubler, it was the region of fatigue crack. Almost all of the fatigue crack was located underneath the doubler and would not have been detectable from the exterior of the aircraft. Further, because the cracking initiated from the external surface of the fuselage skin and propagated inward, the damage also would not have been visually detectable from inside the aircraft until the crack had propagated all the way through the fuselage skin.

Striation estimates performed in connection with this accident investigation revealed that the number of cycles that took for the multiple origin points of the fatigue fracture to propagate through the thickness to the interior of the fuselage skin ranged from approximately 2,400 to approximately 11,000 cycles. However, it is unknown exactly when the crack growth began. Therefore, it would be difficult to estimate how soon after the repair the first signs of cracking would have been detectable<sup>28</sup>. Furthermore, it was unable to determine whether the fatigue cracks had propagated all the way through the fuselage skin or the length of the crack if it had propagated through the skin at the time when B-18255 structure inspection was conducted.

The hidden scratches and associated MSD and fatigue fractures found on B-18255 were certainly serious safety concerns because it could lead to a

---

<sup>28</sup> The NTSB noted that of other instances in which fatigue cracking originating at damage hidden by a repair may not have begun until long after the repair was accomplished, but the crack propagated to failure within as few as approximately 4,000 cycles after it began (see detail in NTSB Safety Recommendation A-03-07 to A-03-10)

catastrophic structural failure. Interview record indicated that the most widely used nondestructive inspection methods for structure inspection at the CAL were the visual and high frequency eddy current inspection. According to the maintenance records, high frequency eddy current had not been used for structure inspection to the section between STA 2060 and 2180 on B-18255. More over, high frequency eddy current inspection is not able to detect cracks through a doubler. Therefore, the crack would still not be detected if external high frequency eddy current had been used for structure inspection.

#### **2.4.1.1 The Last Zonal Inspection in Aft Lower Lobe Area**

According to maintenance records, the last MPV Check was completed on January 10, 1999. The aft lower lobe area was inspected twice during the check, the 1st one was a zonal general visual inspection, and the 2nd was a detailed zonal visual inspection.

The task card content is shown as follows:

1<sup>st</sup> Zonal general visual inspection dated

*JOB TITLE: ZONE 147/148 INTERNAL INSP*

*INSPECT SKIN, STRINGERS, FRAMES, AND SHEAR TIES BS 1920 TO 2160. CHECK THAT DRAIN VALVES OPERABLE.*

*INTENSIFIED INSPECTION. ZONE 147/148*

*STANDARD HR 0.5*

*ELAPSE HR 0.5*

2<sup>nd</sup> Zonal detailed visual inspection dated

*JOB TITLE: FUSE AFT BILGE INTETIOR – INSP*

*PERFORM A DETAILED INSPECTION PER ABOVE WORK INSTRUCTION IN THE FOLLOWING AREAS:*

*INTERIOR OF FUSELAGE BILGE, BS 1480 TO BS 2360*

*STANDARD HR 14.1*

*ELAPSE HR 14.1*

#### **2.4.1.1.1 Bilge Cleaning**

The bilge area was not cleaned in accordance with the CIC cleaning task before the 1<sup>st</sup> Zonal general visual inspection. The standard man-hour specified for this general visual inspection was 0.5 hours.

The CIC cleaning task before structural inspection is an optional item. The operator can decide whether it is necessary by considering cost versus safety. Normally, other than the bilge area, the cleaning task will not be requested. However, for safety reasons, the inspector should perform the job according to the estimated standard time in a defect-identifiable environment. The Safety Council believes that the bilge area should be cleaned before inspection to ensure a closer examination of the area.

#### **2.4.1.1.2 Inspection Area Lighting Condition**

According to the inspector's interview notes, the lighting condition of the working area was not preset during the initial dock-in process. The cabin or other groups set the light when they removed the floors and insulation blankets. The inspector followed the lighting condition as set by previous working groups and used flashlight as he commenced the detail structure inspection. The light set by previous group usually would be only one fluorescent light or two; the inspector can change the light location when the inspection area was beyond the previously set area.

CAL had no lighting standard during a structural inspection. An insufficient lighting environment will affect the safety at the work place and the inspection results. The PPC (Production Planning Control) section should plan the lighting environment for the detailed structural inspection beforehand, or the operator should set up a SOP to ensure a sufficient lighting environment when structural inspections are performed. The Illumination Engineering Society of North America (IESNA) recommends the illumination level of the work place as shown in Appendix 19.

### **2.4.1.1.3 Tools for the Zonal Inspection**

According to the inspector's interview notes, during the detailed structural inspection, the inspector carried a flashlight, mirror and scraper, but left his magnifying glass in his office. He could get one from his office if necessary. The magnifying glass was not a mandatory inspection tool at CAL.

The use of a magnifying glass in structural inspection tasks is a very important practice; however, the inspector who performed the structural inspections at the last MPV in 1998 did so without a magnifying glass. The SRM states that the magnifying glass may be required when performing the structural inspection. It means an inspector should carry a magnifying glass and use it as required. For a structural inspector who did not carry a magnifying glass nor has the magnifying glass as a standard tool during inspection, the result of inspection could be affected.

## **2.4.2 Record Keeping**

The Safety Council was unable to obtain detailed engineering repair assessment and maintenance records for the tail strike repairs in 1980 for B-18255. The records were either missing or could not be located. According to the relevant regulations and procedures of CAA in 1980, the regulations and procedures required operators to keep the complete historical record books that contain aircraft major malfunction, major repair, or major alteration information for a minimum period of 2 years after the aircraft was destroyed or withdrawn from service. Operators, unless otherwise prescribed by Civil Aviation Laws or other requirements, should keep records other than major repairs for at least 90 days.

The aircraft logbook for B-18255 indicated that the aircraft fuselage bottom repair in May 1980 was recorded on the major repair and overhaul record page. However, the present CAL staff did not consider the repair as a major repair and stated that the B-18255 tail strike repair per SRM 53-30-03 was a typical repair, and therefore would be considered as a minor repair. It was not necessary to keep the repair records or to report the repair to Boeing. However, the Safety Council believes that the repair should have been considered as a major repair. Besides, the tail strike repair was recorded on the Major Repair and Overhaul Record page of the Aircraft Logbook. Therefore, the records should have been required to be kept for 2 years after the aircraft was destroyed or withdraw from

service in accordance with the CAA regulations.

During the investigation, the Safety Council discovered that some maintenance activities of B-18255 were not recorded in the maintenance records. In particular, the temporary repair of the tail strike in 1980 was not recorded in the aircraft logbook; several non-routine cards of the 3C/MPV check stated that parts were replaced with no record of the part numbers. In addition, when CAL was conducting the RAP preparation for B-18255 in November 2001, of the 31 doublers found on the aircraft, only 22 had repair records.

Current CAA regulations are stipulated in accordance with ICAO Annex 6 and do not require retention of all maintenance records permanently. The Safety Council understands that permanent records should not include all maintenance records and some records may only need to be kept for a short period of time. However, the Safety Council believes that keeping comprehensive maintenance records is very important for keeping track of the continuing airworthiness of the aircraft, and in particular, all the records of structural repairs should be kept for future reference.

### **2.4.3 The RAP**

#### **2.4.3.1 The CAL RAP**

As mentioned in 1.18.3, according to Boeing RAG D6-36181, B-18255 should complete the repair examination process (stage 1) of the RAP before the aircraft accumulated 22,000 flight cycles. When the CAL System Engineering Department issued the aircraft repair assessment process implementation procedure on May 24, 2001, B-18255 had accumulated about 20,400 flight cycles. The aircraft logbook indicated that B-18255 accumulated an average of 900 flight cycles for the last three years before the occurrence. Therefore, B-18255 would have about 40 months to prepare for the repair assessment as required by Boeing RAG. It was reasonable for the CAL to document the repairs on B-18255 in November 2001 and plan to conduct the repair assessment in accordance with the Boeing RAG at the 7C check in November 2002, which would have been before B-18255 accumulated 22,000 flight cycles.

The Safety Council understands that when a continuing airworthiness requirement is introduced, the operators need to consider numerous factors,

such as the degree of urgency of the unsafe condition, the amount of time necessary to accomplish the required actions, the maintenance schedules, etc., to decide when and how to adopt the requirements. However, the Safety Council also believes that when operators receive a safety related airworthiness requirement, the operators should assess and implement the requirement at the earliest practicable time. A review of accidents in aviation history reveals that several accidents could be attributed to a modification prescribed in the airworthiness requirements/service bulletin that had not been incorporated into the aircraft before the accident<sup>29 30</sup>. It is not necessary to wait until the deadline to implement the modifications.

### **2.4.3.2 The CAA RAP**

In general, a mandatory continuing airworthiness requirement, such as the RAP, is developed by aircraft manufacturers and approved by the relevant State of Design<sup>31</sup>. Individual States of Registry then determine what aspects of the program should be mandatory for aircraft of that type on their register.

The FAA amended four operational rules, 14 CFR Parts 91.410, 121.370, 125.248, and 129.32 to require operators of US-registered aircraft and foreign operators having their aircraft fly into the airspace of United States to perform RAP. Such rules became effective on May 25, 2000. These operational rules are "mandatory continuing airworthiness information" as defined by ICAO Annex 8, PART II, paragraph 4.3.2<sup>32</sup>. The basic statement in each rule is that no person

---

<sup>29</sup> Aircraft Accident Investigation Commission, AIRCRAFT ACCIDENT INVESTIGATION REPORT 96-5, China Airlines Airbus A300B4-622R, B1816 Nagoya Airport, April 26, 1994

<sup>30</sup> DGAC India, Civil aviation aircraft accident summary for the year 1995, East West Airlines, Fokker F27, July 1 1995

<sup>31</sup> The RAP was developed by an industry team, which included the manufacturer. A continuing airworthiness requirement could also be completely defined by the regulator with no manufacturer involvement.

<sup>32</sup> 4.3.2 - The State of Design of an aircraft shall transmit any generally applicable information which it has found necessary to the continuing airworthiness of the aircraft and for the safe operation of the aircraft (hereinafter called mandatory continuing airworthiness information) as follows: ...[Annex 8, Ninth Edition, July 2001]

Note 1. – In 4.3, the term "mandatory continuing airworthiness information" is intended to include mandatory requirements for modification, replacement of parts or inspection of aircraft and amendment of operating limitations and procedures. Among such information is that issued by Contracting States in the form of airworthiness directives. [Annex 8, Ninth Edition, July 2001]

may operate [one of the affected models] beyond the applicable flight cycle implementation time, unless repair assessment guidelines have been incorporated within its inspection program. The FAA gave final approval to Boeing RAG documents in February 2001.

According to ICAO Annex 8 paragraph 4.3.3:

*The State of Registry shall, upon receipt of mandatory continuing airworthiness information from the State of Design, adopt the mandatory information directly or assess the information received and take appropriate action.*

Paragraph 4.2.2:

*The continuing airworthiness of an aircraft shall be determined by the State of Registry in relation to the appropriate airworthiness requirements in force for that aircraft.*

*The State of Registry shall develop or adopt requirements to ensure the continued airworthiness of the aircraft during its service life.*

The CAA stated that CAA was aware of the RAP in 2000. According to Article 137 of Aircraft Flight Operation Regulation, the operator has the obligation to follow the manufacturer's continuous airworthiness information and recommendations. In addition, the FAA did not issue RAP related AD at the time. Furthermore, because there were only a few aircraft that would fall into the aging aircraft category in Taiwan, the CAA did not take any action to adopt the program into the system immediately. When the CAL proposed its RAP to the CAA, the CAA approved the program and requested CAL to provide training for their maintenance personnel.

Since CAA did not issue any form of documentation to request operators to adopt the RAP, the RAP was not a mandatory program in Taiwan before the accident. Nevertheless, CAL decided to incorporate the program into its maintenance program based on the CAL's own assessment. Although CAA stated that before the accident, ROC's registry did not list any aging aircraft other than CAL's five B747-200s, thus, there were no other aging aircraft operators to notify, and CAL had initiated the RAP within the timeframe specified in the FAA amended rules. The Safety Council believes that, when ROC's registry may be

affected by the continuing airworthiness information from the State of Design, the CAA should take proactive approach to monitor the introduction of that continuing airworthiness information, such as the RAP, and consider adopting the information directly or taking appropriate action.

On October 15, 2002, CAA issued AC 120-017 and cited the requirement of Article 6 of the Regulation for Aircraft Airworthiness Certification to reiterate that all operators have to comply with the airworthiness requirements issued by CAA or the civil aviation authority of the State of Design before the deadline of the compliance date.

On April 2, 2003, CAA issued AD2003-03-020A to require all operators to take immediate action to evaluate all previous repairs of any pressurized fuselage for approved data/records and to ensure that repairs were accomplished in accordance with approved data.

## **2.4.4 CPCP Overdue Inspection Issues**

### **2.4.4.1 CAL CPCP Inspection Time Control**

CAL performed the first CPCP inspection on B-18255 in 1993. The inspection interval of CPCP inspection item 53-125-01 was 4 years; therefore, the second CPCP 53-125-01 inspection should have been in 1997. CAL scheduled the second CPCP 53-125-01 inspection in the following 1PD check in 1998, which was 13 months later than the required 4-year inspection interval. Neither CAL nor CAA were aware that implementation of the inspection was delayed until November 2003 during the ASC's investigation process, after the accident.

According to records, starting from 1997, B-18255 had a total of 29 CPCP inspection items that were not accomplished in accordance with the Boeing 747 Aging Airplane Corrosion Prevention & Control Program Document and CAL AMP. Consequently, the aircraft had been operated with safety deficiencies from 1997 onward.

According to Boeing 747 Aging Airplane Corrosion Prevention & Control Program Document D6-36022 Rev. D, CPCP inspection interval was controlled in calendar years. In order to fit into the CAL maintenance schedule computer control system, CAL estimated the average flight time or flight cycles for each aircraft and scheduled the calendar year based inspection interval into different



letter checks. For instance, if the inspection items were in a 2-year interval, the inspection items would be scheduled at the every other C checks; if the inspection items were in a 5, 6, or 8-year intervals, they would be scheduled at every D check. The risk of this type of maintenance schedule was that when the aircraft was operating in a low flight time/flight cycle condition, such as the case for B-18255, the calendar year inspection limitation for the CPCP inspection might arrive before the scheduled letter check, which would cause the CPCP inspection to be delayed or overdue.

In 1996, the CAL Maintenance Planning Section (MPS) of the System Engineering Department discovered that scheduling all the CPCP inspection items at the letter check might cause an inspection overdue problem. Therefore, MPS amended the AMP to change all CPCP inspection intervals from letter checks to calendar year control. CAA approved the AMP amendment regarding the scheduling plan.

At the same period of time, when the CPCP scheduling changes were made, the MPS issued a memorandum to the Maintenance Operation Center (MOC) of the Line Maintenance Department to ask MOC to notify the MPS when the CPCP inspection items were near the inspection intervals.

After CAL amended the AMP to change the CPCP inspection intervals from letter checks back to the calendar years, the inspection delay or overdue issues should no longer have existed. However, according to interviews and CAL internal records, although the CPCP inspection was controlled by the MPS, after the MPS memorandum was issued to the MOC, the MPS was relying on the MOC to perform the interval control. When the MOC received the memorandum from the MPS, the MOC changed the inspection interval of the C-check from 13 months to 12 months, therefore, if the CPCP or other major inspection interval was every 2 years, the inspection would be scheduled at every other C check. The MOC believed that the problem should be solved. In addition, CPCP inspection control was not one of the MOC job functions and since the computer control system was not programmed to control the maintenance schedule by calendar year, the MOC did not monitor the progress of the CPCP inspection intervals. In another words, the CPCP inspection interval issue was not monitored by any organization within the CAL EMD after the MOC amended the C check interval, which was believed to be the solution of the problem.

The MOC amendment of the C-check interval from 13 months to 12 months did solve part of the problem. Those CPCP inspection items with 2 or 3-year inspection intervals, scheduled at every 2 or 3 C checks, there were no delayed implementation or overdue issues. However, for those CPCP inspection items with longer inspection intervals, they were scheduled at either every PD (MPV) or D checks. When the aircraft was operating in a low flight time/flight cycle condition, such as B-18255, the implementation of inspections was delayed or overdue.

The Safety Council believes that miss-communication between the MOC and MPS sections resulted in the failure to input calendar-year inspection data into the computer control system. In addition, the self-auditing system at CAL did not detect the difference between flight hours requirement versus the calendar-year inspection requirements causing several of the CPCP inspections to be late or overdue.

#### **2.4.4.2 Consequences of CPCP Overdue**

As the result of the CPCP being overdue, B-18255 was deficient in the required CPCP inspections from November 30, 1997 to May 25, 2002. Although these outstanding CPCP inspections were not necessarily related to the accident, during that period of time, the aircraft would have been operated in a higher risk situation than those aircraft that have been maintained according to schedule.

There are 29 overdue inspection items in total, consisting of 4-year, 5-year, 6-year and 8-year intervals. For items that required 4-year interval there should have been three maintenance chances (1993, 1997, and 2001) to conduct the inspections. CAL accomplished those inspections twice, in 1993 and 1998.

For items requiring a 5-year interval there should have been 2 maintenance chances to conduct the inspections, 1993, and 1998. CAL performed the inspection twice but the inspection in 1998 was delayed for two months.

For items requiring a 6-year interval there should have been 2 maintenance chances to conduct the inspections, 1993, and 1999. CAL completed one inspection for those items in 1993.

For items requiring a 8-year interval there should have been 2 maintenance chances to conduct the inspections, 1993, and 2001. CAL completed one

inspection for those items in 1993.

When the four-year inspection interval was missed, B-18255 operated with a safety deficiency from November 30, 1997 to Dec 28, 1998. Since that date CAL's CPCP control program started to deteriorate. Even though the bilge inspection was conducted in December 1998, the 5-year interval items came due in 1999 and made the aircraft late in corrosion inspections again. The items to be inspected at every 6 and 8 years made B-18255 late in corrosion inspections from November 1999 to May 25, 2002. The Safety Council concludes that B-18255 was operated with unresolved safety deficient condition from November 30, 1997 to May 25, 2002, except for the period from January 1999 to November 1999.

#### **2.4.4.3 Deficiencies in the CAL EMD**

CAL holds a Certificate of Repair Station issued by CAA and is responsible for developing a CAA approved system of maintenance that adequately provides for the continuing airworthiness of that aircraft. According to CAA regulations AOR Article 129 the operator shall ensure that each aircraft operated is maintained in an airworthy condition according to procedures acceptable to the CAA.

The Safety Council noted that the calendar years were the only dominant concern in the CPCP, however CAL neither recognized the effect of slow accumulations of flight hours and flight cycles nor monitored the yield rate of CPCP items. The effectiveness of the CAL aircraft maintenance program was further limited by the lack of work schedule planning method in the computer system for CPCP items. The overall condition of CAL EMD indicated that engineers came to accept the on-going computer system based on flight hours and flight cycles as a normal operating system. That resulted in CPCP inspections being delayed and overdue.

CAA regulations require CAL to be responsible for ensuring that the approved maintenance program is complied with. CAL did not have adequate procedures to assure complete compliance with the CPCP inspection intervals. CAL's EMD and self-audit system did not detect or ensure that all requirements of the CPCP program were met.

## **2.4.5 CAA Oversight of the CAL Maintenance Program**

According to the CAA Airworthiness Inspector's handbook, the duties and responsibilities of the airworthiness inspector is to ensure that the maintenance activities of the operator continue to meet all regulatory requirements. The inspector reviews the operator's continuing airworthiness maintenance program based on the manufacturer's maintenance program to ensure that the operator has made timely revision in accordance with the latest version published by the manufacturer. Based on which, the inspector will conduct subsequent spot checks of the operator's maintenance activities. Negative trends depicted in the Reliability Program are investigated and corrective actions must be included in the maintenance program and monitored for effectiveness.

In addition to approving the operator's continuous airworthiness maintenance programs, CAA also performs regular conformity inspections for program adherence. Daily flight hours/cycles recorded for the aircraft and the dates of scheduled maintenance inspections of various checks are monitored on a periodic basis to ensure the scheduled inspection activities comply with the intervals specified in the approved maintenance program.

For B-18255, CAA conducted the last record inspection upon the annual renewal of B-18255's airworthiness certificate in 2001 prior to the accident. The maintenance records of B-18255 inspected by CAA included the A, B, C, D checks, ADs, weight & balance information, major repairs and alterations, time change items, etc. CAA did not specifically review the CPCP records in 2001, because CPCP program was incorporated into Aircraft Maintenance Program. CAL did not have separate CPCP inspection records. The CPCP records were mixed within the B-18255 maintenance records. With this procedure, it would be difficult to trace the CPCP inspection intervals during the maintenance records inspection.

B-18255 maintenance records indicated that, for all 47 CPCP inspection items, 1 item was overdue in 1997, 12 items were overdue in 1998, 8 items were overdue in 1999, and 8 items were overdue in 2001. The items that should have been inspected in 1999 and 2000 had not been accomplished before the accident. The deficiency in the CAL maintenance system was not discovered during CAA's oversight of the CAL maintenance programs for more than 5 years.

The CAA's oversight of the operator's system of inspection and maintenance did

not detect the deficiency in the scheduling of CPCP inspections over several years. The records were inadvertently designed in a way that did not expose the deficiency easily to either the CAA or the carrier. The Safety Council believes that CAA should establish a periodical maintenance records inspection procedure at appropriate intervals to ensure that all work required to maintain the continuing airworthiness of an aircraft has been carried out. In particular, the inspection procedure should verify whether all the maintenance specified in the maintenance program for the aircraft has been completed within the time periods (flight hours, cycles, and calendar years) specified. The Safety Council also believes that CAA should encourage the operators to establish a maintenance record keeping system that would provide a clearer view for the inspector/auditor for records review.

According to the CAA, CAA has mandated operators to review and revise, as necessary, maintenance record keeping procedures to assure compliance with pertinent regulations. This means that records will be required to provide a clearer view of what is required and what is done.

#### **2.4.6 Continuing Airworthiness Challenges**

An aircraft should be operated safely as long as its prescribed structural inspections of the significant structures and systems are carried out as scheduled. The idea is that the aircraft structure can sustain anticipated loads in the presence of fatigue, corrosion, or accidental damage until such damage is detected through scheduled inspections, and the damaged part is replaced or repaired in accordance with approved methods.

The result of the item 640 wreckage examinations indicated that a pre-existing crack was on the aircraft skin underneath the doubler between STA 2060 and STA 2180 before the accident flight. The fatigue crack that occurred on B-18255 was not detected in any scheduled structural inspection nor any other inspections until the residual strength fell below the fail-safe capability. Examination of item 640 found hidden Multiple-Site-Damage (MSD) as well as significant metal fatigue. MSD is one of the two sources of Widespread-Fatigue-Damage (WFD), it is characterized by the simultaneous presence of cracks at multiple structural details that are of sufficient size and density that the structure will no longer meet its damage tolerance requirement

and could catastrophically fail<sup>33</sup>.

Although damage at multiple sites has been addressed in residual strength analyses since 1978<sup>34</sup>, the presence of widespread fatigue damage can significantly reduce the strength of the structure. The safe damage detection period between the threshold of detection and limit load capability may also be reduced in the presence of WFD. In particular, because of the multiple forms of WFD and low probability of detection, WFD is particularly dangerous. It would be essential that the aviation community be able to assess WFD with high confidence and understand its risks to aircraft structural integrity.

Considerable activities were undertaken by the Structures Airworthiness Assurance Working Group (AAWG) to address WFD concerns and resulted in development of recommendations for audits of structures with regard to WFD and recommended inspection programs. However, the design of those programs have not considered issues of poor workmanship, or inadequacies in implementation of designated procedures from each sectors involved in the process, such as the operators, government authorities, or even international auditing efforts.

The aviation industry is continually evolving, with significant changes in aircraft design philosophy, maintenance programs, and inspection processes. These developments impose further pressure on both operators and civil aviation authorities to keep pace with the changing aviation environment. The accident depicted in the report, and inspections of repairs on older aircraft that carried out since the accident, clearly demonstrate that a combination of inappropriate systems and inadequate maintenance activities could lead to undetected hidden structural damage to the aircraft pressure vessel, with the possible ultimate result of an aircraft accident.

As demonstrated in the case of CI611, the accident aircraft had a serious hidden structural defect that may or may not be detectable during the course of regular maintenance. A more effective non-destructive structural inspection method

---

<sup>33</sup> FAA, Structural Integrity of Transport Airplanes. <http://aar400.tc.faa.gov/programs/aging/aircraft/structural>

<sup>34</sup> The regulatory changes of FAR 25.571 in 1978 to require that damage tolerance evaluation must consider WFD.

should be developed to improve the capability of detection of hidden structural defects. The Safety Council urges the aviation community to further the development process of an effective, time saving technology to prevent the recurrence of such tragic accident as CI611.

## 2.5 Residual Strength Analysis

A further study of the structural stress and residual strength analysis was conducted in order to assess the effect of the pre-existing cracking on the integrity of the structure<sup>35</sup>. “Residual strength” is the strength capability of a structural component for a given set of damage, or cracks. Residual strength analysis is used to determine the critical damage length. Critical damage is the maximum damage, including multiple site damage (MSD) that can exist before the capability of the structure falls below regulatory load conditions. It should be noted that regulatory load conditions are typically significantly higher than the maximum operating load<sup>36</sup> expected to occur during a typical flight.

For the investigation of CI611 a residual strength analysis of the skin/frame assembly in the vicinity of the pre-existing crack was conducted. Firstly, the operating stress was calculated by a linear Finite Element Model (FEM)<sup>37</sup> of the aft body structure. Secondly, the residual strength calculation was accomplished in two phases. The first phase considered the crack lengths less than two-bay length (40 inches) and was conducted with an FAA-accepted analytical method. The second phase included the use of nonlinear FEM<sup>38</sup> analysis to model the unique configuration of Item 640. This model was used to evaluate the residual strength of the crack length beyond 40 inches and to account for the presence of the repair doubler.

---

<sup>35</sup> The structural analysis had to be conducted with Boeing's proprietary data for B747-200 structural and material characteristics. Because of the manufacturer's proprietary requirement, the Safety Council cannot conduct an independent analysis strictly on its own. Therefore, the Safety Council requested a structural analysis from Boeing Commercial Airplane Company (BCAC) and later on worked in conjunction with both Boeing and NTSB regarding the stress load of the frames and the residual strength of the skin in the vicinity of the pre-existing crack. Such practices had been carried out by the investigation agencies throughout the world for years.

<sup>36</sup> The load experienced during typical day-to-day aircraft ground and flight operation.

<sup>37</sup> The FEM was developed by Boeing and its detail is considered to be proprietary information of the BCAC. The Safety Council was not able to obtain the data to conduct an independent analysis. Detail of the FEM is not presented due to its proprietary nature.

<sup>38</sup> The nonlinear FEM was developed at Boeing specifically for the analysis of CI611 accident. It is also considered as proprietary information of the BCAC.



## 2.5.1 Operating Stress

The cabin pressure load was carried by hoop tension in the skin with no tendency to change shape or induce frame bending. Normal operating load, 8.9 psi, representing the cabin/ambient pressure difference, was used for the calculation of the operating stress.

A linear finite element method was used to evaluate the operating stress field. The aft-body structure (fuselage structure from STA 1480 aft) was modeled using a NASTRAN FEM as shown in Figure 2.5-1. This model consists of local refinement (Figure 2.5-2) in the vicinity of STA 2100 frame to allow placement of skin discontinuities (representing a skin crack) and to provide enhanced visibility on local stresses.

The operating stress calculated by the FEM was then verified by the real plane pressure gauge measurement test, which indicated that the model overestimated the skin stress by 6%. Therefore, a 6% reduction of the operating stress model calculated by the FEM is used for the residual strength analysis.

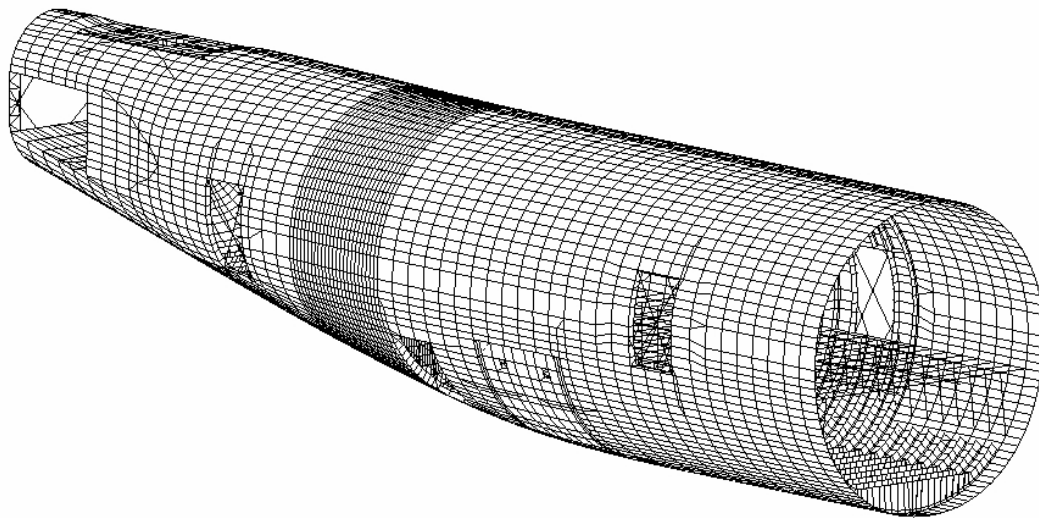
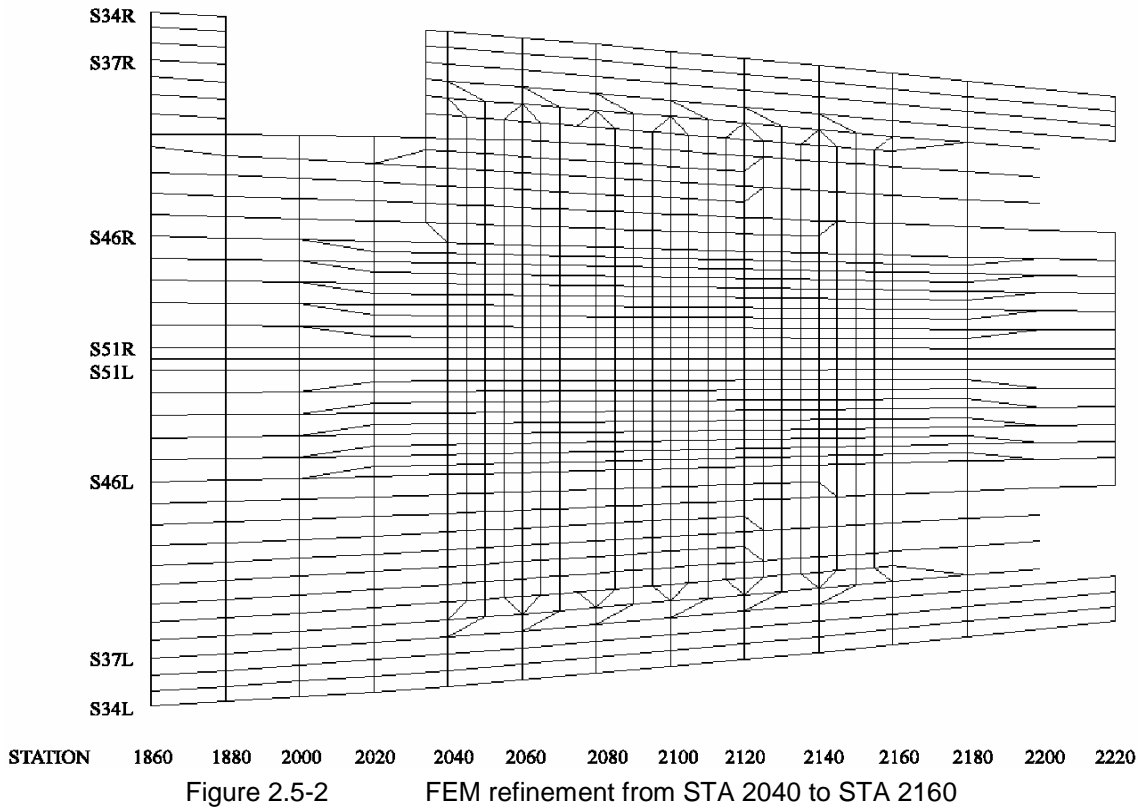

Figure 2.5-1 The linear finite element model of B747-200 aft fuselage



## 2.5.2 Residual Strength for Crack Length up to 40 Inches

Phase one of the analysis was to determine the capability of the skin given the stable, flat-fracture, through-thickness fatigue crack as confirmed by the CSIST and BMT. It considered the main 15.1-inch long through thickness fatigue crack centered at STA 2100 frame as well as the MSD. MSD adjacent to the leading crack could further reduce the residual strength of the skin. The degree of reduction in its residual strength is dependent on the size of the MSD, and its proximity to the leading crack defined by the length of the ligament. A local ductile fracture could occur between the leading crack and the adjacent MSD once the reduced residual strength of the skin is lower than the applied stress (Figure 2.5-3).

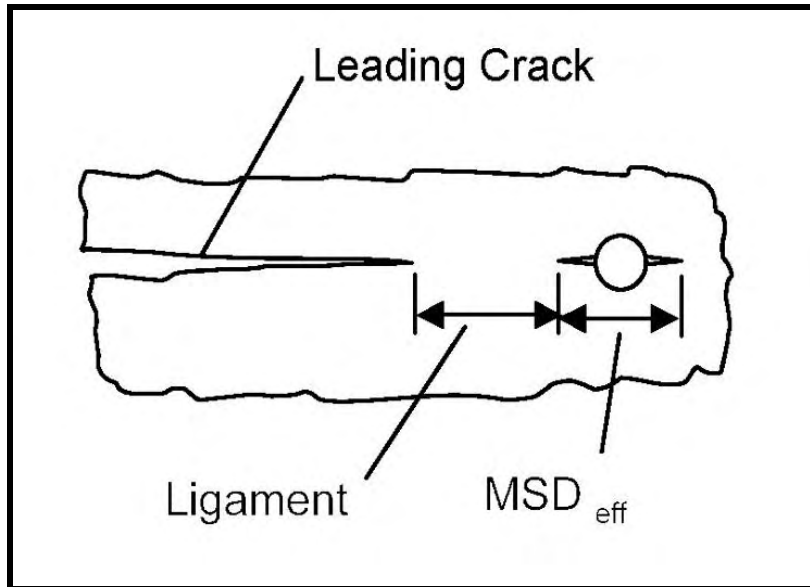

Figure 2.5-3 The relation between the leading crack and MSD

The reduction factors were calculated for the forward and afterward MSD adjacent to the leading crack. The leading crack would link to the MSD hence yield a relatively lower strength and then a new leading crack formed. The result of the final calculation was shown in Figure 2.5-4.

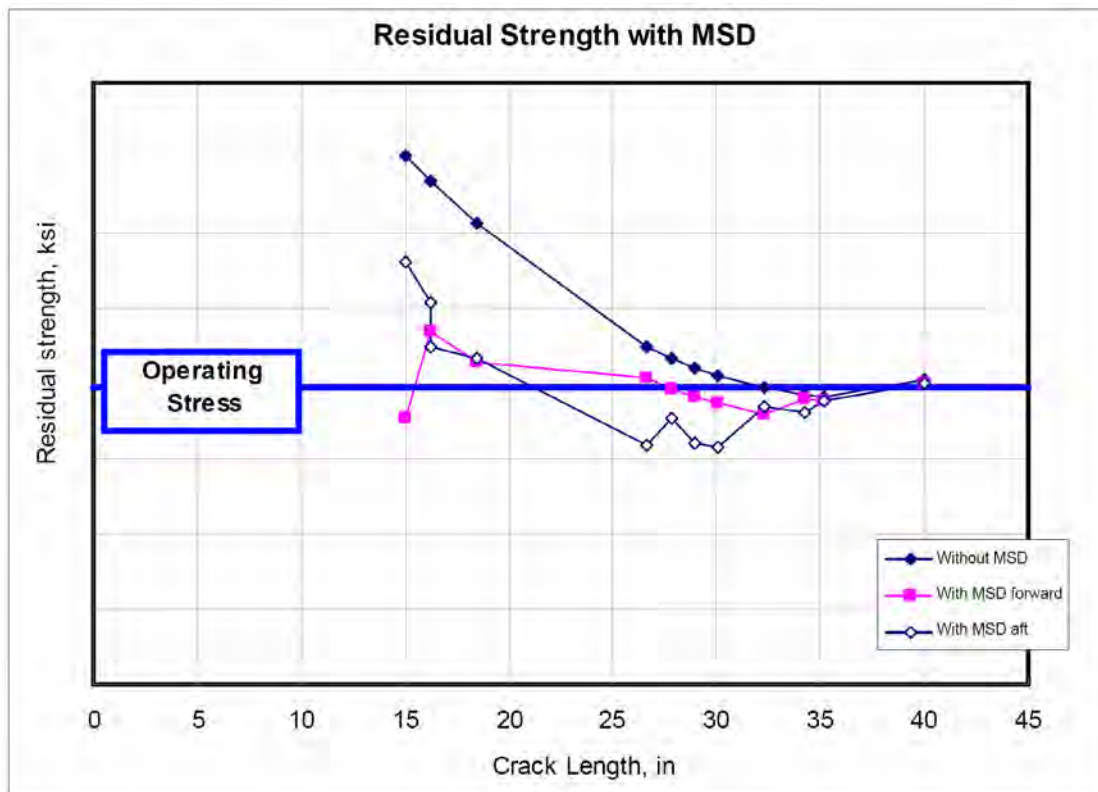

Figure 2.5-4 The residual strength of the crack length up to 40 inches

The upper curve of the Figure 2.5-4 shows the capability of the discontinued skin assembly without MSD. The lower two curves represent the residual strength capability of the skin assembly reduced by MSD effect within the two-bay region. These two curves indicated that the fatigue cracks identified in the two bay region should begin linking together as an overall crack length of 21 inches formed. For Item 640, once the crack grew to 35 inches, the MSD is no longer a factor in the residual strength capability, and then only the upper curve (without MSD) should be considered. Noted that at a two bay length (40 inches), the calculated residual strength capability and the operating stress are essentially equivalent.

### **2.5.3 Influence of the Repair Doubler**

The repair doubler could prevent the skin from bulging outward when the aircraft was pressurized as Figure 2.5-5 shows. It also allows increased load redistributing around the cracking area to increase the residual strength of the skin. The factor of the influence on the residual strength was determined by a non-linear finite element model developed for the case of C1611. The model provides values that can be compared to and correlated with the established analysis in Section 2.5.2. Employing this model, with the effect by incorporating the repair doubler to determine the resulting increase in residual strength when the skin is not allowed to bulge, was evaluated. The upper curve in Figure 2.5-6 represents the calculated increase in residual strength with the effect of the repair doubler for up to a two-bay skin crack.

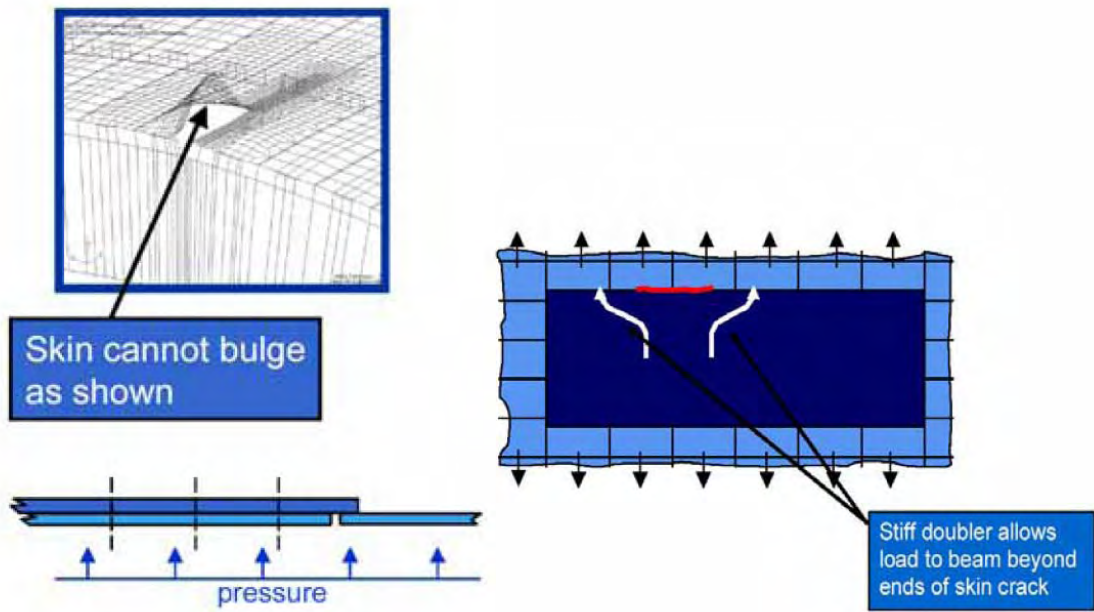

Figure 2.5-5 The influence of the repair doubler

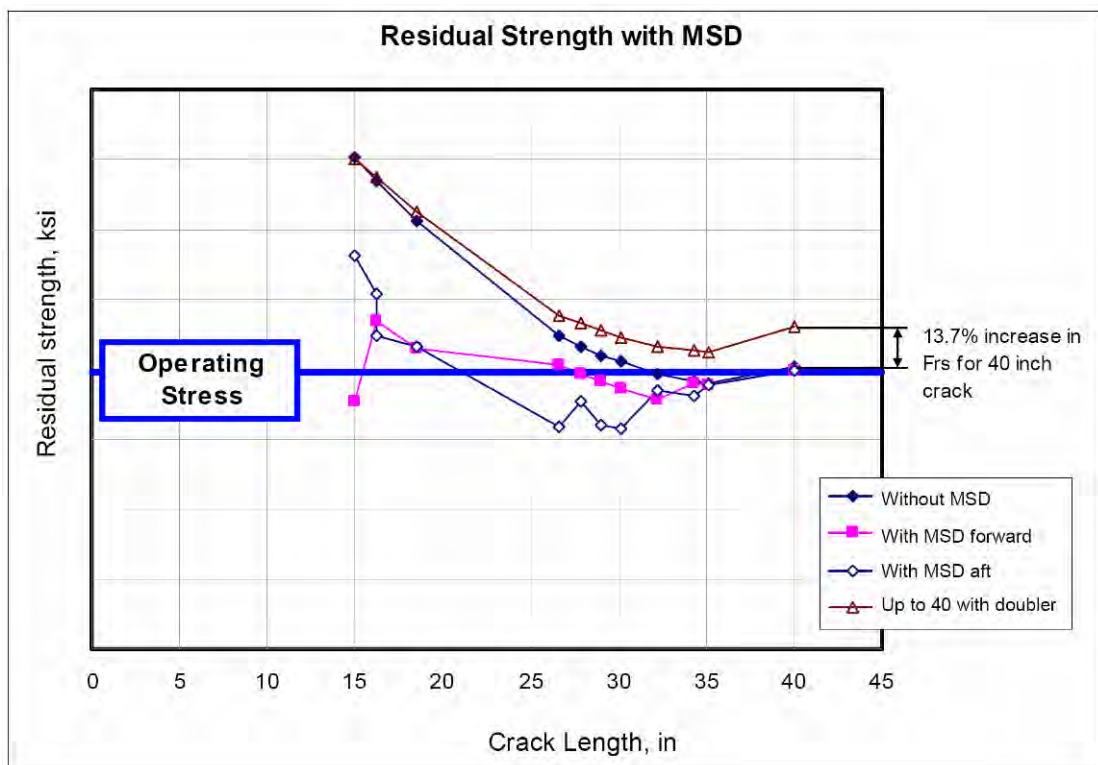

Figure 2.5-6 Residual strength of crack length up to 40 inches (with doubler)

## 2.5.4 Residual Strength of Cracking Length up to 90 Inches

The nonlinear FEM was also used to assist in determining the values for the residual strength beyond two bays (40 inches) of skin damage. Figure 2.5-7 represents a comprehensive residual strength analysis for the skin assembly, showing the calculated capability of the skin for cracks extending beyond 40 inches. This analysis includes both the basic residual strength for a cracked panel and the increased residual strength with the installation of the repair doubler. It can be seen that the influence of the repair doubler is less pronounced toward the extents of the pre-existing crack. This is primarily due to the inability of the repair doubler to sustain beam loads around the cracked area as the crack starts to approach the ends of the repair doubler.

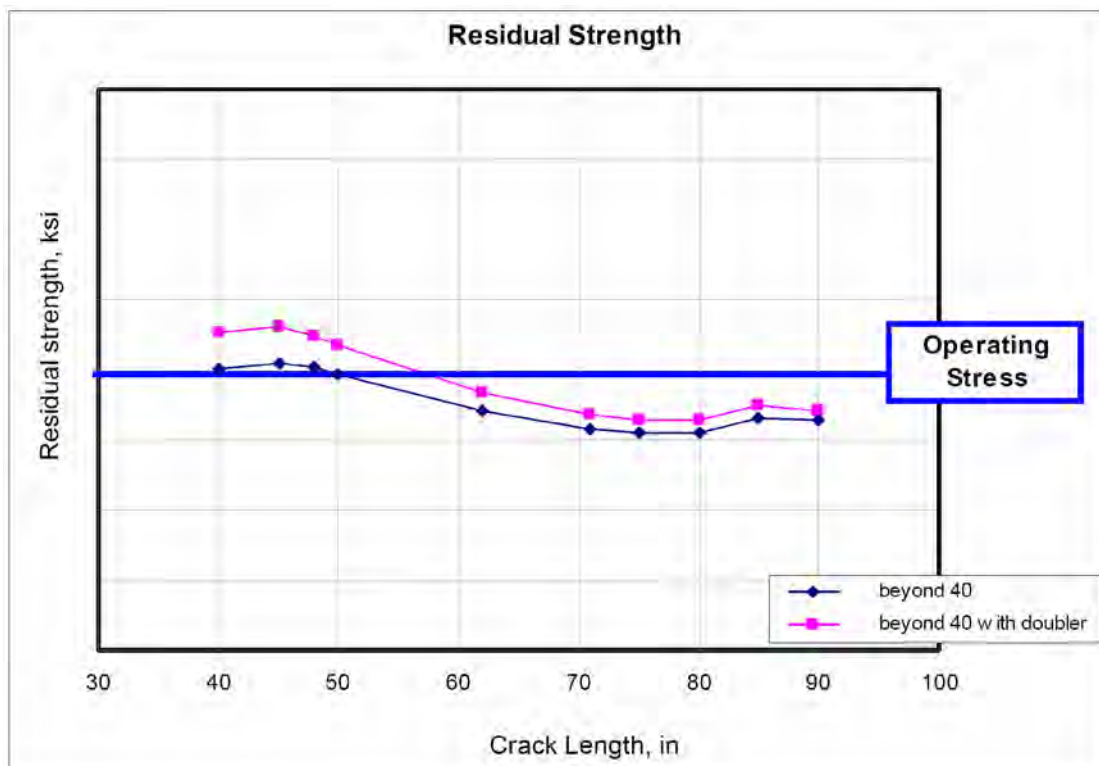

Figure 2.5-7 The residual strength of the extents of the crack up to 90 inches

A combination of all the above results is shown in Figure 2.5-8. It shows the MSD region, the residual strength without MSD, and the repair doubler effects for crack lengths ranging from 15 to 90 inches.

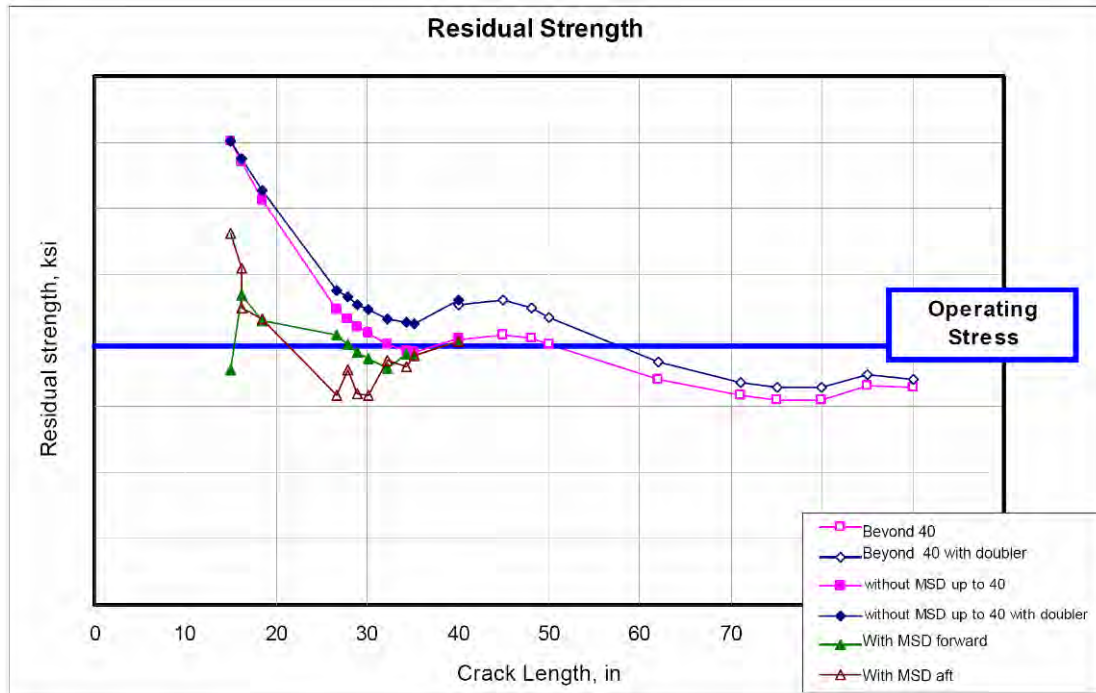

Figure 2.5-8 The combination of the two-stage residual strength analysis

### 2.5.5 Summary

Based on the structural analysis in this section, the following observations can be made:

- The MSD is sufficient to cause the local linking of the cracks within a two-bay region (40 inches). Beyond this region, the MSD is no longer a factor in the residual strength capability;
- The capability of the skin assembly is very near the operating stress value when the skin crack is approaching two bays out to the extents of the pre-existing crack;
- The residual strength increases slightly when the crack has just progressed beyond a frame location (at 40 inches and 80 inches). This is a known frame influence phenomenon that has been observed in previous analyses and testing;
- The majority of the residual strength loss occurs in the first two bays (the residual strength of the skin does not decrease significantly beyond two bays); and
- The residual strength of the skin around STA 2100 area with the pre-existing crack and the repair doubler went below the operating stress as the crack region exceeds 58 inches.

## 2.6 CVR Related Analysis

In this section, the Safety Council provides analyses related to the sounds recorded by the CVR. Specifically, the last 130 ms of the sound spectrum were analyzed. Two other issues are also addressed; the dilemma that the two recorders registered different stopped times, and the analysis of the unidentified sounds recorded by the CI611 CVR.

### 2.6.1 CVR and FDR Stopped Time

The CVR recording started at 1456:12<sup>39</sup> and continued uninterruptedly until 1528:03. The FDR stopped recording at time 1527:58.9. The FDR time is usually more accurate than CVR, because its' recording was in digital format. The tape based CVR has less sophisticated time measurement capability, due to variation in its drive-motor speed and elasticity of the tape. The time at which the two recorders stopped was different even after attempts of time synchronization as indicated in section 1.11. To clarify the ending times of the two recordings, the Safety Council took into account a third reference; the recording of the air-ground communication from the Taipei Area Control Center (TACC), which contained several events that were common to the CVR. TACC has an analog tape recorder with digital clock indication. The Safety Council made a digital copy of the recording from 1516:10 to 1528:20. This period of recording covered the last transmission from CI611 and the communication between TACC and EF126<sup>40</sup>, which was also recorded by the CVR. The time correlated events recorded by TACC and the CVR are shown as Table 2.6-1

Table 2.6-1 Time events on ATC clock

TACC time	CVR time	Source	Common event contents
1516:31.0	1516:31.0	RDO1	from chali direct to kadlo recleared tree five zero dynasty six one one
1527:37.1	1527:40.1	EF126	(conversation with TPE ACC)

One may observe that there is a three-second difference between the ATC clock

---

<sup>39</sup> The time reference is base on the Makung radar station time.

<sup>40</sup> Far Eastern Flight 126 was in the vicinity at the time of the accident.



and the CVR clock of the same event (EF126).

Base on TACC time, the CVR ending time was 1527:59.9. When compared to the FDR ending time of 1527:58.9, there is a one-second difference. The time correlation between the FDR data and CVR was based on the recording of VHF keying with a resolution of one second, and the time difference between the CVR and the FDR is also one second. The Safety Council thus concludes that the ending time of both recorders are within the resolution of one-second and therefore the stop time of the two recorders should be considered the same. The time difference between the two recorders was due to the inaccuracy in the CVR drive motor and tape elasticity.

## **2.6.2 Sound of Overpressure Relief Valve Opening**

To familiar with the sound of overpressure relief valves opening, the investigation team performed a flight test<sup>41</sup> to simulate the cabin overpressure during climb. When the aircraft altitude was about 25,000 feet and the indicated airspeed was about 300 knots, one of the pressure relief valve opened at 9.2 psid, the other one remained closed. When the valve was opening, the test team in the cockpit could not hear the sound of the opening, but could feel the air flow when the pack number 2 valve was tripped due to the pressurization system design. The CVR and FDR of the test flight were brought to ASC's Lab for further analysis. The recording on the CVR was analyzed but it could not reveal the sound differences of valve opening and tripping of pack no.2. The ASC concluded that the current CVR system could not record the sound of overpressure relief valve operation.

## **2.6.3 Unidentified Sounds**

The CVR transcript has a total of 38 of unidentified sounds, 1 no signals, and 6 of sounds similar to signal interference. There are 14 items recorded prior to the aircraft rotation, 28 items from rotation to altitude alert, and 3 items after altitude alert<sup>42</sup> to the end of the recording. The items after rotation, totally 31, are analyzed.

---

<sup>41</sup> Refer to 1.16.1 Data Collection Flights

<sup>42</sup> Alert for approaching the selected altitude.

Eight unidentified sounds were attributed to the tape damage and one with no signal was attributed to the tape splicing. Figure 2.6-1 frame #1 to #3 shows the typical tape damage and frame #4 shows the spliced area. Several sounds were identified as possible sounds from a toggle switch, or other switches. Because of high noise background, sounds from switches are difficult to be identified, such as momentary switch, switch movements, keyboard entries on the INS panel, switch on the audio selector panel, etc. Some unidentified sounds are likely the sound of crew motions but they might not be directly related to any operational action. Table 2.6-2 lists the unidentified sounds and their associated possible events.

Thus, the Safety Council concludes that with current technology, other than the last sound spectrum before power cut-off, the unidentified sounds offer no useful information related to this investigation.



Figure 2.6-1 Damaged and spliced tape areas

Table 2.6-2 Unidentified sounds and possible events

Item	Local Time (radar time)	Source	Content	Remark
	1507:52	CAM1	vee one	
	1507:56	CAM1	rotate	
15	1507:57	CAM	(unidentified sounds)	similar to nose gear lift off
16	1508:17	CAM	(unidentified sound)	similar to toggle switch
17	1511:36	CAM	(unidentified sounds)	similar to toggle switch
18	1514:00	ALL_TK	(no signal for 0.3 seconds)	tape spliced area
19	1514:07	CAM	(unidentified sounds)	note*
20	1518:28	CAM	(unidentified sounds)	unidentified
21	1518:35	CAM	(unidentified sounds)	note*
22	1519:06	CAM	(unidentified sound)	note*
23	1519:27	CAM	(unidentified sounds)	note*
24	1520:34	CAM	(unidentified sounds)	note*
25	1520:53	CAM	(sound similar to signal interference)	Tape sustained minor wrinkle
26	1521:03	CAM	(sound similar to signal interference)	Tape sustained minor wrinkle
27	1521:04	CAM	(sound similar to signal interference)	Tape sustained minor wrinkle
28	1521:07	CAM	(sound similar to signal interference)	Tape sustained minor wrinkle
29	1521:07	CAM	(sound similar to signal interference)	Tape sustained minor wrinkle
30	1521:11	CAM	(sound similar to signal interference)	Tape sustained minor wrinkle
31	1521:14	CAM	(sound similar to signal interference)	Tape sustained minor wrinkle
32	1521:51	TRACK 2	(unidentified sound similar to squelch break)	sound similar to squelch break
33	1521:54	TRACK 2	(unidentified sound similar to squelch break)	sound similar to squelch break
34	1522:00	TRACK 2	(unidentified sound similar to squelch break)	sound similar to squelch break
35	1522:06	TRACK 2	(unidentified sound similar to squelch break)	sound similar to squelch break

Item	Local Time (radar time)	Source	Content	Remark
36	1522:10	TRACK 2	(unidentified sound similar to squelch break)	sound similar to squelch break
37	1522:13	TRACK 2	(unidentified sound similar to squelch break)	sound similar to squelch break
38	1522:22	CAM	(unidentified sound)	note*
39	1523:08	CAM	(unidentified sound)	note*
40	1524:10	CAM	(unidentified sound)	Tape damage
41	1527:16	CAM	(unidentified sounds)	note*
42	1527:33	CAM	(unidentified sound)	note*
	1527:39	CAM	(sound similar to altitude alert)	
43	1527:40	CAM	(unidentified sounds)	note*
44	1527:46	CAM	(unidentified sound)	sound similar to toggle switch
45	1528:03	CAM	(unidentified sound, end of CVR)	see paragraph 2.6.4
note*: Likely the sound of crew movements but might not be directly related to any operational action				

## 2.6.4 The Last Sound Signature

As discussed in section 2.2.3, the time of the sound wave propagates from an event source via air or aircraft structure to reach specific point on the aircraft are different, such time difference can be referred to as the precursor in the CVR recording. Comparing the signatures of the precursor and the event sound can provide the possible propagation path of event sound, and therefore estimated the possible area of the source of the event sound.

Before the CVR signature comparison, one should understand that the comparison is valid only when the recording is within the dynamic range of recording system. If the breakup area were very close to the cockpit, both the precursor and event sound usually would saturate the recording system. The precursor sound level sensed by the CAM depends upon the sound energy in the structure. Sound with high frequency content is generally reflected by the hard structure, while majority of sound energy transmitted through the structure is with the low frequency content. Usually the CAM is sensitive in low frequency

content; therefore the CAM is normally the only microphone sensitive to the precursor. The boom microphones, which are isolated from the aircraft's structure by the pilot's body, are not.

As the sound propagates, the microphone will sense it, and the signal is recorded on the CVR. A lot of factors can affect the final recording. For the same recorder system and same environment, the precursor and event sound are affected differently by the factors such as the frequency and energy of the sound source, the distance of propagation, and the propagation media. To understand difference between the precursor and event sound, let's simplify the propagation paths for the precursor and event sound as follows.

**Path I: for precursor**

Sound source→fuselage structure→CAM

**Path II: for event sound source at non-pressurized area**

Sound source→ambient air→fuselage structure→air in cabin and cockpit→CAM

**Path III: for event sound source at pressurized area**

Sound source→air in cabin and cockpit→CAM

The major difference between path II and path III was whether the event sound propagated through fuselage. When the thickness of aircraft aluminum skin is greater than 0.064 inch, the sound energy ( $f > 200\text{hz}$ ) will be attenuated more than 20 dB<sup>43</sup>. Since the fuselage structure will greatly attenuate the sound energy, the energy of the event sound sensed by CAM would be much less than the sound propagated only via air. For instance, the TransAsia Airways 543 accident, an Airbus A320 aircraft, collided with a construction vehicle in landing roll. The aircraft sustained substantial damage on its left landing gear, left wheel well, left inboard trailing edge flap and left fuselage aft lower skin. The first impact was on the left wheel well, which was in a non-pressurized area. The signature of the precursor and event sound is shown in Figure 2.2-3. The level of

---

<sup>43</sup> Some Noise Transmission Loss Characteristics of Typical General Aviation Structural Materials, J. Roskam, C. van Dam and F. Grosveld, *University of Kansas, Lawrence, Kan.*; and D. W. Durenberger, *General Dynamics, Fort Worth, Texas*

signature of precursor is obviously higher than the event sound on the CAM channel.

If the event sound propagated via air in cabin and cockpit, but without the fuselage attenuation, the event sound level would be recorded with significantly higher energy. For instance, the UNI Air 873 accident; an explosion took place on the left overhead luggage compartment of the forward fuselage of a MD-90 aircraft in the landing roll. The energy level of the event sound was very high on the CAM channel, because the explosion area is very close to the cockpit; the level of precursor is also high (Figure 2.6-2).

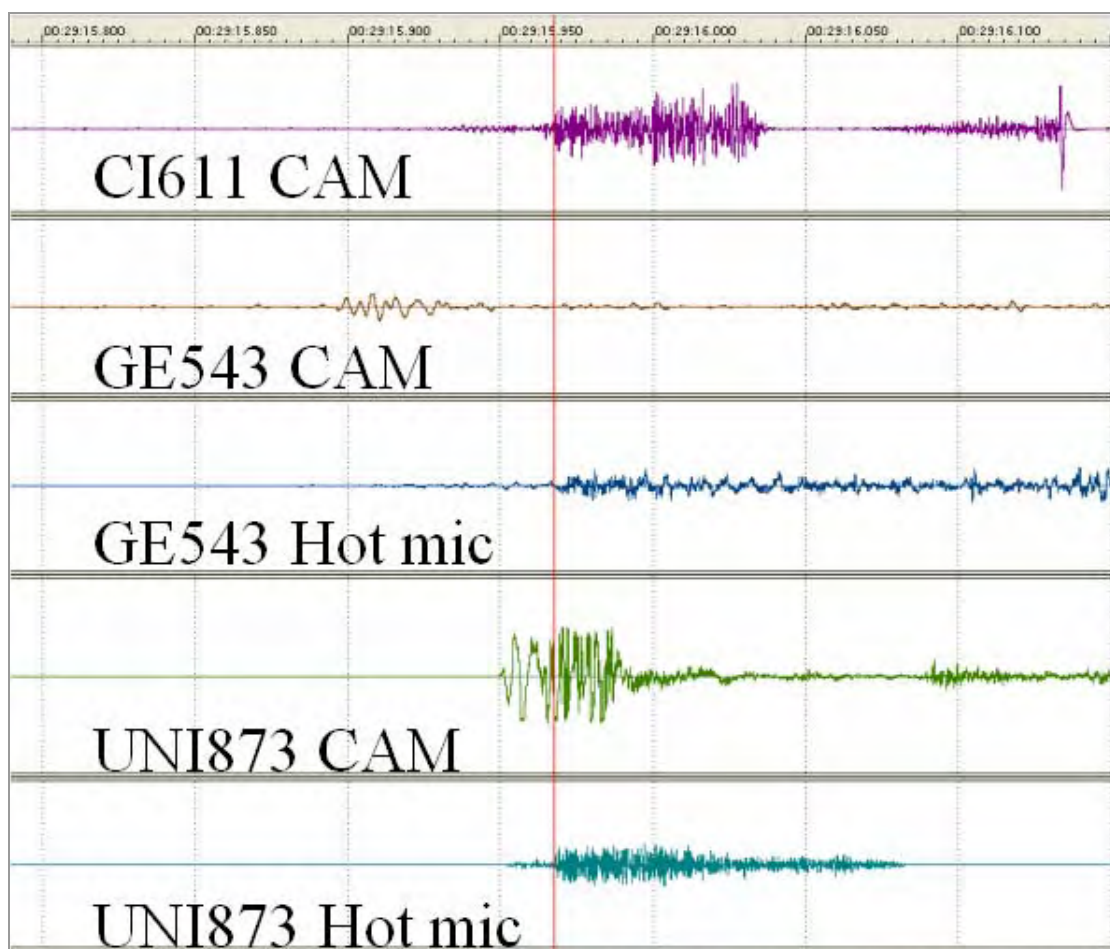

Figure 2.6-2 Comparison of the sound spectrum of three accidents

If the breakup is in the non-pressurized area, the fuselage structure will behave like a sound insulator that reduces the sound energy to the CAM. In this case the event sound level would be less than the precursor level. In the case of CI611, the event sound level is much higher than the precursor sound level. Based on these analysis, the Safety Council concludes that the structure breakup area

was most likely in the pressurized area.

## **2.6.5 Summary**

Base on above analysis, conclusions are made as follows:

1. Based on the time correlations analysis of TACC air-ground communication recording, the CVR recording, and FDR recording, both CVR and FDR stopped at the same time of 1527:59±1 second.
2. Except the last sound spectrum, all other sounds from the CI611 CVR recordings yield no useful information to this investigation of this accident.
3. The Safety Council concludes that the origin of the sound of CI611 was most likely in a pressurized area. This conclusion is based on the sound spectrum analysis of the last 130 ms before power cut-off.

The sound spectrum from the recorders of CI611 aircraft can provide only very limited information to the investigation. After the aircraft broke-up and the CVR power was cut-off, even the aircraft was still flying, there was no verbal information from pilots nor aural warning from aircraft systems could be recorded by CVR. Similar situation happened in TWA800, UA811 or other abrupt in-flight breakup accidents. The Safety Council believes that if there were back-up CVR and FDR installed nearby the cockpit with Recorder Independent Power Source (RIPS), more information could be provided to the investigators.

## 2.7 Pressurization and Pneumatic System Anomalies

This section provides an analysis related to the pressurization and pneumatic systems documented in Chapter 1 of this report. It includes the Cabin Pressure Control Selector Panel, Air Conditioning (Pack Control) Panel, and Pressure Relief Valves.

### 2.7.1 Cabin Pressure Control Selector Panel

Based on the examination, the Cabin Pressure Control Selector Panel (shown in Figure 2.7-1) is deformed, delaminated and fractured. The examination and test results show that the mode switch was in the “MAN” (manual) position.



Figure 2.7-1 Cabin pressure control selector panel

In accordance with CAL B747-200 (SP) “Airplane Operations Manual”, Section 6.0, Normal Procedures, CM3 should place the selector in the “AUTO” position during completion of the cockpit preparation checklist. The Safety Council considered three possibilities for the selector to be in the “MAN” position.

1. CM3 positioned the selector to “MAN” as part of the procedure to deal with a pressurization problem during the climb. If a pressurization problem occurred, procedures call for CM3 to move the selector to “MAN” in order to control the pressurization system manually to modulate the outflow valves.
2. CM3 might have placed the mode selector in “MAN” position intentionally for some unknown reason in order to control the pressurization system manually.
3. The “MAN” position of the pressure control selector could have been caused



by aircraft breakup, water impact, underwater recovery or ground handling.

The first possibility can be discounted to a large extent because, if a pressurization problem had occurred during the climb, there most certainly would have been conversation among the flight crew recorded on the CVR. There was no evidence in their conversation that the flight crew was dealing with such a situation before the accident. Laboratory examination of the cabin altitude indicator, the cabin altitude vertical speed indicator, and the cabin differential pressure indicator revealed no evidence of malfunction or other indications that a pressurization difficulty was encountered by the flight crew.

Both the second and the third scenario could explain the position of the selectors, but it can not be confirmed with the information available. The Aviation Safety Council was not able to determine with any certainty why the Cabin Pressure Control Selector Panel mode switch was in the “MAN” (manual) position.

## **2.7.2 Air Conditioning Panel**

The Air Conditioning Panel (Shown in Figure 2.7-2) is bent back on both sides of the center area, then forward at left and right edges. Most of light plate is missing.

Examinations and test results of the panel revealed that the bleed air valve switches for engines number 1 and 2 were found in the “Close” position. The bleed air switches for engines number 3 and 4 were found in the “Open” position. The Boeing 747-200 Airplane Operations Manual “Final Cockpit Preparation” and “Engine Starting” checklists specify that all four engine bleed valve switches be placed in the “Open” position, after engine start and normal flight.

One possible reason for the flight crew to place the bleed-air valves switches to “close” position would be due to the pressurization system malfunction. The CM-3 might also unintentionally have turned the two engine bleeds off in distress or disorientation when the occurrence happened.

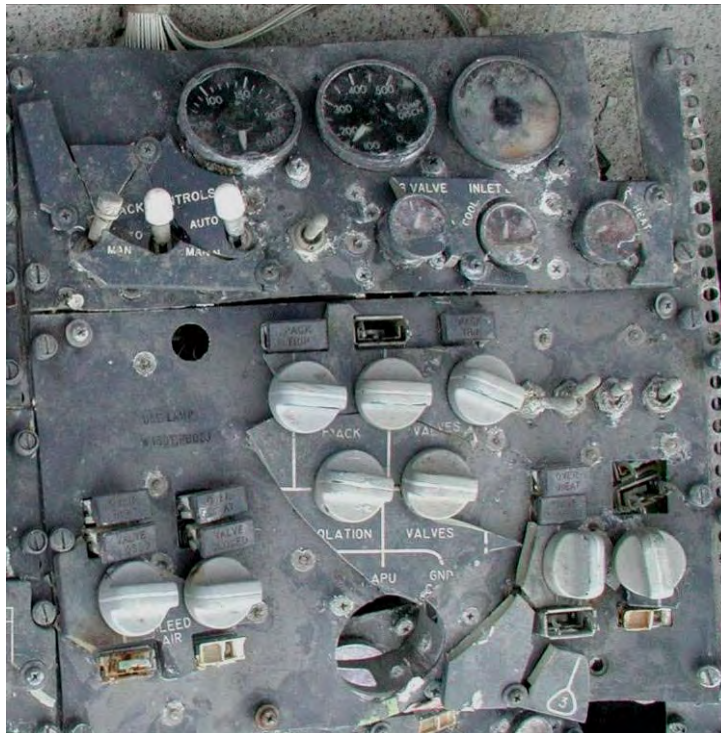

Figure 2.7-2 Air conditioning panel

Examination and test results of the air conditioning panel revealed that two of the three air conditioning “pack” valve selectors were found in the “Closed” position and another one was found in the near closed position. The normal operating procedures for CAL B747-200 specify that at least two pack valves be in the “open” position after engine start, and CM3 shall check the setting after takeoff and during climb. Also, CM3 is required to verify two packs “Open” after takeoff and during the initial climb. The CVR transcript reveals that CM3 verbally confirmed that two packs were “Open.”

A possible explanation for the flight crew to place the “pack” valves selectors in the “Close” position is a pressurization system malfunction, however, the pressurization system malfunction issue may be discounted due to lack of conversation among the flight crew recorded on the CVR regarding over pressurization in cabin.

The Aviation Safety Council was not able to determine with any certainty why two of the four engines’ bleed valve selectors and all three packs valve selectors were in the “Closed” position. There is no reasonable explanation for the position of the engine bleed valve switches, unless CM3 accidentally moved the selectors to the “Close” position, as part of an attempt to complete an emergency

decompression or another unknown reason. Again, the abnormal switch positions may have been caused by aircraft breakup, water impact, underwater recovery or ground transport.

### 2.7.3 Pressure Relief Valves

Two cabin pressurization relief valves are installed to relieve excessive pressure in the cabin. Both valves were recovered as shown in Figure 2.7-3. All flapper (blowout) doors (upper and lower for both valves) and some hinge pins are missing. The Lower Pressure Relief Valve was no longer attached to the structure. The structure between the upper and lower valves was buckled outward.



Figure 2.7-3 Pressure relief valves.

The purpose of the pressure relief valves is to prevent the aircraft fuselage from being over pressurized. The pressure relief valves remain closed in normal operation. If a failure in the pressurization control system, or an incorrect setting of cabin altitude leads to cabin pressure exceeding its design criteria, the pressure relief valves will open to prevent cabin over pressurization and consequent structural damage.

The structure of the pressure relief valves is shown in Figure 2.7-4<sup>44</sup>, there are two flapper doors installed on the door housing. Each flapper door fastens up the door housing with two shear (hinge) pins (Item 300 on Figure 2.7-4). The shear pins are the center of rotation while the flapper doors rotate around them. The maximum rotation angle of the flapper door is 90 degrees from its close position. These shear pins can move freely with respect to the shaft installed on the housing (Item 280 on Figure 2.7-4). There is another pin (Item 275 on Figure 2.7-4) that passes through each shear pin and the flapper door hinge at a 90 degrees angle to the shear pins. Therefore, item 275 pins are basically normal (perpendicular) to aircraft fuselage skin when the flapper doors are closed, and would be found parallel to the fuselage skin, if the doors were open.

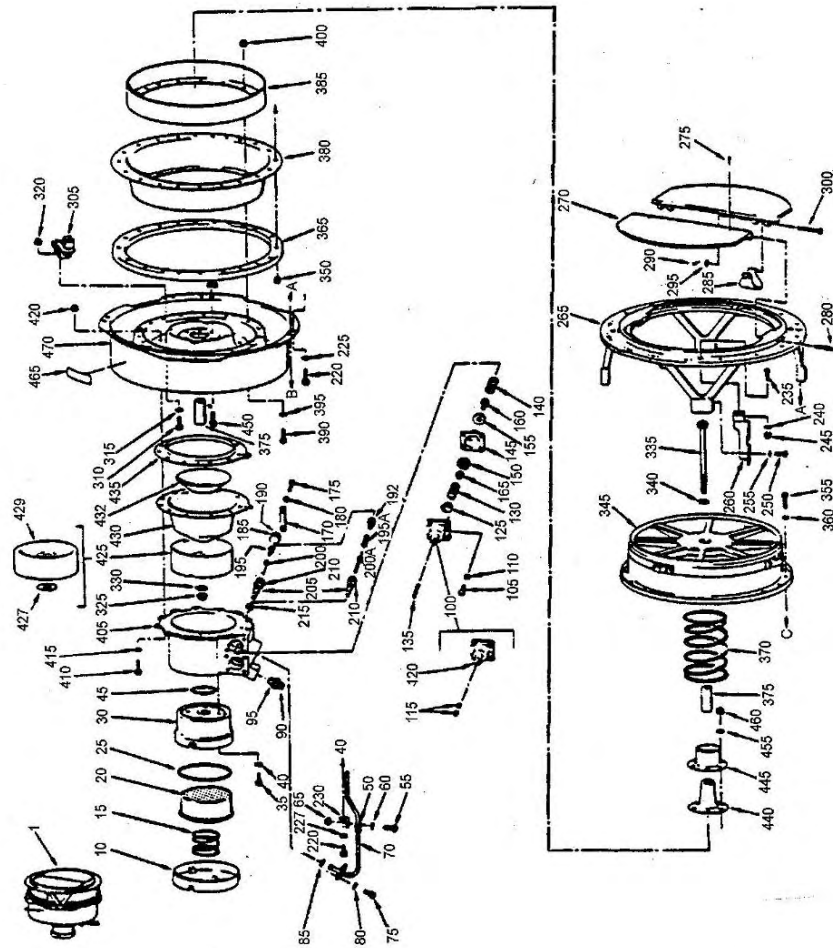

Figure 2.7-4 Break down of the pressure relief valve

<sup>44</sup> Hamilton Sundstrand overhaul manual 715995, page 1120

### 2.7.3.1 Upper Pressure Relief Valve

The visual inspection result shows the Upper Pressure Relief valve (Figure 2.7-5) has been deformed inward, the blowout doors are missing, the gate web fractured, FWD upper hinge pin is bent, lower hinge pin missing, AFT lower hinge pin is bent and all hinge pins are moveable.



Figure 2.7-5 Upper pressure relief valve

X-Ray on the upper relief valve control switch was conducted. The results show that the control sensor assemblies were deformed from their original setting as shown in Figure 2.7-6.

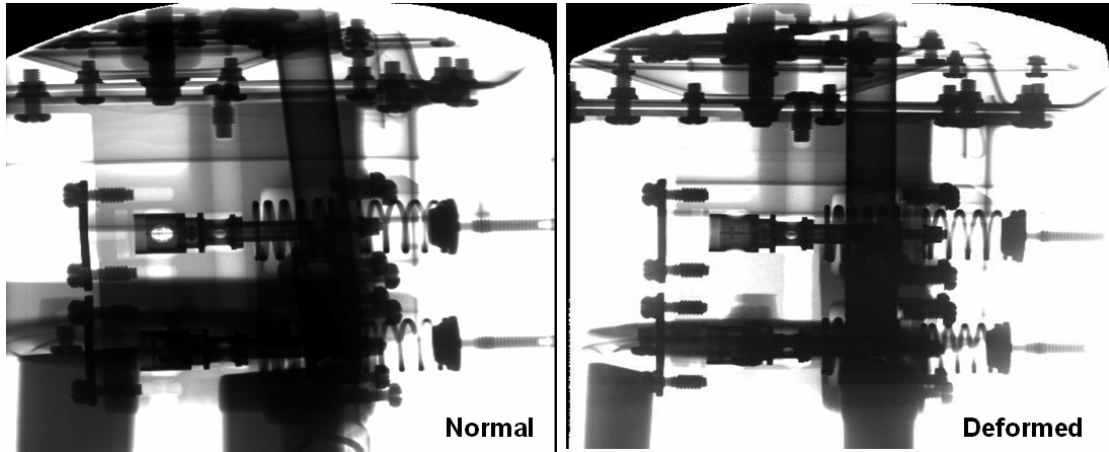

Figure 2.7-6 X-ray check results

The measurement of pin angles was performed using a flat reference plane (outer skin of aircraft); using two imaginary reference lines running between the centerlines of the pin mounting holes (upper fwd to upper aft) & (lower fwd to lower aft). All angular measurements were based from these two imaginary lines as shown in Figure 2.7-7. Results of the measurements are:

Upper aft pin was approximate  $13^\circ$ ; Upper fwd pin was approximate  $161^\circ$ ; Lower aft pin was approximate  $53^\circ$

Blue lines represent the centerline of the bushings

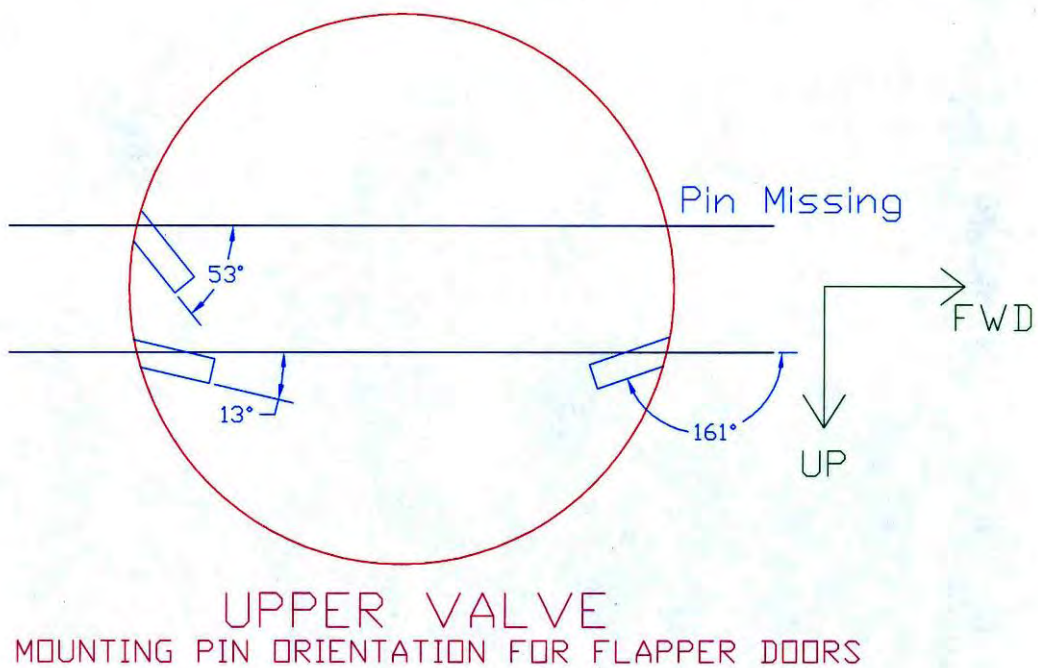

Figure 2.7-7 Upper flapper doors pins measurement results

The wreckage examination results show that the upper pressure relief valves had been deformed inward, the flapper doors were missing and the three out of four existing shear pins were bent-in, but moveable. It could be that outside-in forces crushed the relief valve and damaged the flapper doors and the web gate. Those three pins of item 275 were still attached to the shear pins and are parallel to the relief valves housings (aircraft fuselage skin) that might indicate the valve doors was open before the water impact. However, based on the test results, the Safety Council could not conclude whether the door was open prior to the water impact.

### **2.7.3.2 Lower Pressure Relief Valve**

After laboratory examination, the Safety Council found no useful information from the examination of the Lower Pressure Relief Valve.

### **2.7.4 Summary**

There is insufficient supporting information on the state of the aircraft's pressurization and pneumatic systems, as the outflow valves were not recovered, the open or close position of the recovered pressure relief valve is not certain, and the FDR did not have cabin pressure as one of its recorded parameters. There was nothing in crew's conversation to indicate any potential over pressurization problem in the cabin before the accident. Therefore, the Safety Council cannot determine the rational explanation regarding the abnormal positions of the Flight Engineer's panel switches.

According to ICAO Annex 6<sup>45</sup>, the large transport category aircraft shall have 32 mandatory parameters to be recorded for TYPE I flight data recorder. According to EUROCAE ED-112<sup>46</sup>, the large transport category aircraft shall have 78 mandatory parameters to be recorded for CLASS A flight data recorder. In addition, FAA has mandated that in 2008, all FDR installed in part 121 and part

---

<sup>45</sup> ANNEX 6, Part II. International Standards and Recommended Practices, International General Aviation- Aeroplanes. Sixth edition, July 1998.

<sup>46</sup> ED-112 MINIMUM OPERATIONAL PERFORMANCE SPECIFICATION FOR CRASH PROTECTED AIRBORNE RECORDER SYSTEMS. 27 January 2003

135 category aircraft shall have 88 parameters. However, those 88 mandatory parameters do not include cabin pressure.

In spite of the numbers of the mandatory parameters required by ICAO, EUROCAE, and FAA, the cabin pressure parameter still is an optional parameter. If CI611 had cabin pressure as one of the parameters recorded in the flight data recorder, the possibility of cabin over pressurization could be answered readily.



## **2.8 Injury Pattern**

This section describes the injury patterns of the recovered victims. Of the 225 people on board the accident flight, 175 were recovered.

### **2.8.1 Explosives and Fire**

Examination of the victims' remains revealed no indication of penetration of fragments, residual chemicals, burns or blast injuries that would be associated with a high-energy explosion or fire on-board. This is consistent with the examination of the aircraft wreckage.

According to a review of the medical examination records available, the Safety Council believes that the injuries to the victims were the result of multiple traumas and consistent with in-flight breakup and subsequent water impact.

### **2.8.2 Cabin Environment**

According to the CVR, at 1514:26, the fasten seat belt sign was turned off. Therefore, some of the passengers may have unfastened their seat belts and left their seats. When the structural failure occurred with the breakup of the aircraft, cabin furnishings and some occupants were likely ejected from the aircraft. Search and recovery findings support this conclusion. However, many other occupants would have remained strapped into their seats and remained within the fuselage as it struck the water.

### **2.8.3 Victims' Postmortem Examinations**

From the safety investigation standpoint, postmortem examinations of human remains after an aircraft accident are essential not only just for the identification the causes of death and injuries, but to assess the possibility of corrective actions in order to reduce future injury or death rate.

During the investigation, the Safety Council planned to collect information of the victims such as forensic documentation, injury pattern, seat and seatbelt condition and clothing conditions, to assist in the safety investigation. Victims' data mentioned above was provided by several different medical or rescue

organizations. For instance, postmortem examiners of Ministry of Justice performed examinations and provided examination reports of the victims. The divers of the rescue and salvage companies provided body recovery information. The Safety Council obtained limited postmortem information. The reasons are as following:

1. Insufficient time to conduct a detail postmortem examinations: Because of oriental culture, victims' bodies were requested by families as soon as possible before safety investigation examination can be performed. Under such condition, the primary task of the medical examiners was to determine the identity of the victims and to issue death certificates to the families, not for safety investigation. For example, the middle ears and skin of most of the victims were not examined and documented, and internal examinations of most of the victims' lungs were not conducted. As the result, some valuable information may have been lost in this complex accident.
2. Lack of requirements in Taiwan to perform autopsy on the victim of aviation accident: Other than the three flight crewmembers, none of the cabin crew or passengers was autopsied. Autopsy can provide valuable information to accident investigators in any complex aircraft accident investigation. For safety investigation, it is preferable to establish the rule of autopsy to aviation occurrence victims. For instance, in performing the autopsy of lungs tissue, middle ears, and skin of the crewmembers and passengers may help to explain and identify the degree of decompression during the accident.

## **2.9 Ballistic Analysis**

This section employs the ballistic analysis to assess the CI611 accident aircraft break-up sequence immediately after its in-flight breakup. Seven major groups of data as described in Chapter 1 are used; the SSR data, the PSR data, Doppler weather data, the recovered wreckage location, weight and shapes of the recovered wreckage pieces, wind profiles provided by both CAA weather center and NTSB, and the ocean current information provided by the Ocean Research Institute of Taiwan.

### **2.9.1 Altitude Increase after Initial Breakup**

Detailed information of the SSR return was described in section 1.8.4. Taiwan's radar received last SSR return at 1528:03 (34,900 ft), Xiamen radar from Mainland China continued receiving SSR returns until 1528:14. Three additional Mode-C altitudes were received: 10,500m (34,613ft), 10,600m (34,777ft), and 10,620m (34,843ft). Question was raised with regard to the altitude increases sensed by the Xiamen radar. Since the aircraft pitch stability depends on the relative location of the lifting surfaces (wing and horizontal tail) and the center-of-gravity. The horizontal tail provides a downward (negative) lift necessary to make the aircraft stable in pitch. After the empennage separated, the forward body would be expected to pitch downward initially as the effects of both the horizontal tail downward load and weight were removed.

As the aircraft lost its tail section, erratic movement in both altitude and attitude of the aircraft resulted after breakup that might have generated large lateral and pitching motions, which would affect the pressure sensed at the aircraft's static ports. Large errors in pressure altitude could result.

Thus, the Safety Council believes that the last three Mode-C altitudes received by the Xiamen radar could be inaccurate.

### **2.9.2 Correction of PSR Return Signals**

Detailed information about the PSR returns was described in section 1.8.6. It is important to note that, because there were no Mode-C altitudes in those returns, their positions were all assumed to be zero altitude, it means that the slant range

between the return signals and radar site were considered lying in the same horizontal plane. In order to analyze the initial breakup conditions from the PSR returns, FL320 and FL200 are selected to re-process the positions of the return signals during two time durations, 27:55 ~ 28:35 and 28:35 ~29:20.

There are three initial PSR returns at 1528:08 surrounding the SSR radar track of CI611. After correction, one position was re-located to the up-wind side and two positions were re-located to the down-wind side. Figures 2.9-1 and 2.9-2 superimpose the corrected PSR return signals, the SSR radar track from 1527:58 to 1528:10, and positions of major wreckage pieces. Three dashed lines on Figure 2.9-1 represent the three initial primary radar returns at FL320, FL200, and 0 feet.

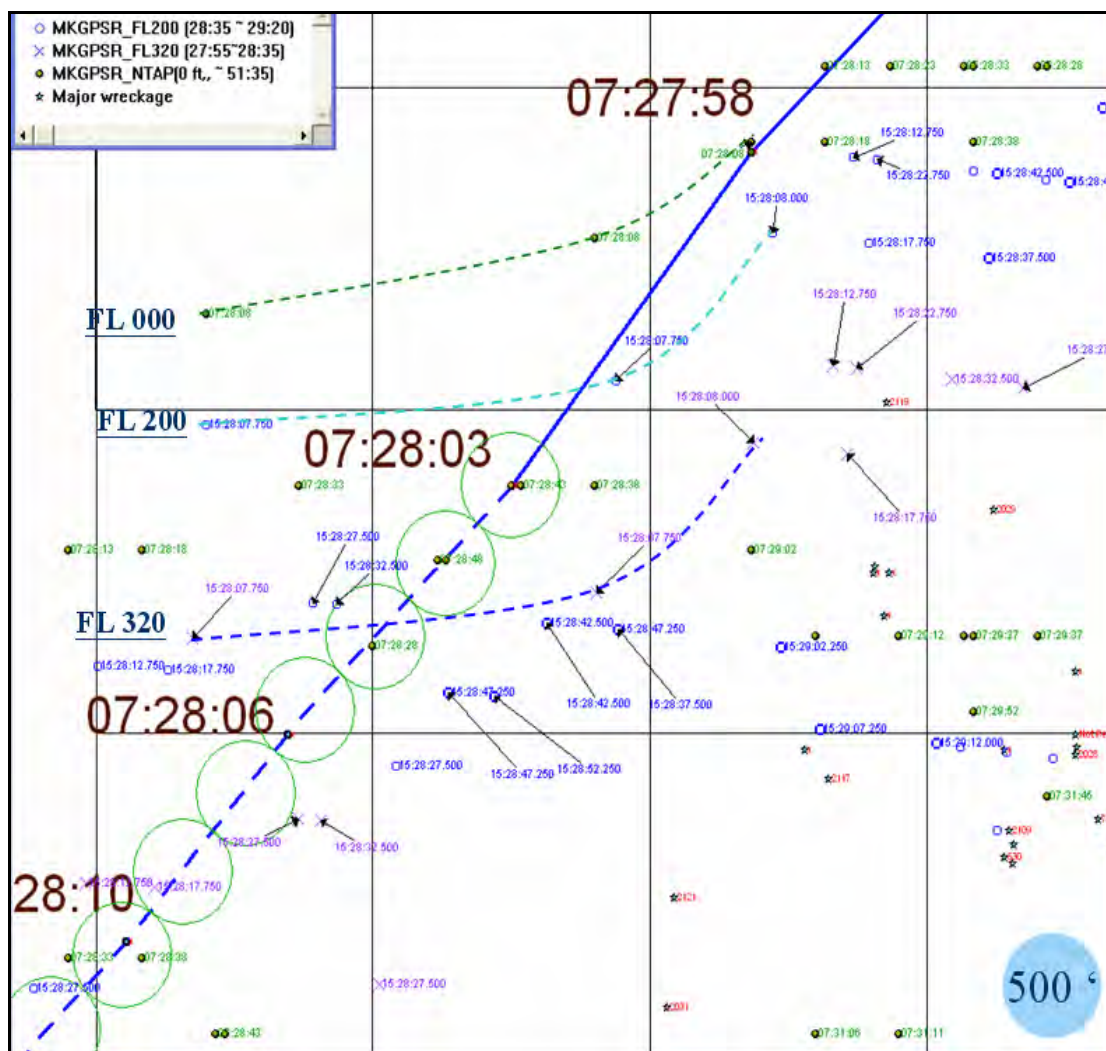

Figure 2.9-1 SSR track, PSR returns with altitude correction (red zone).

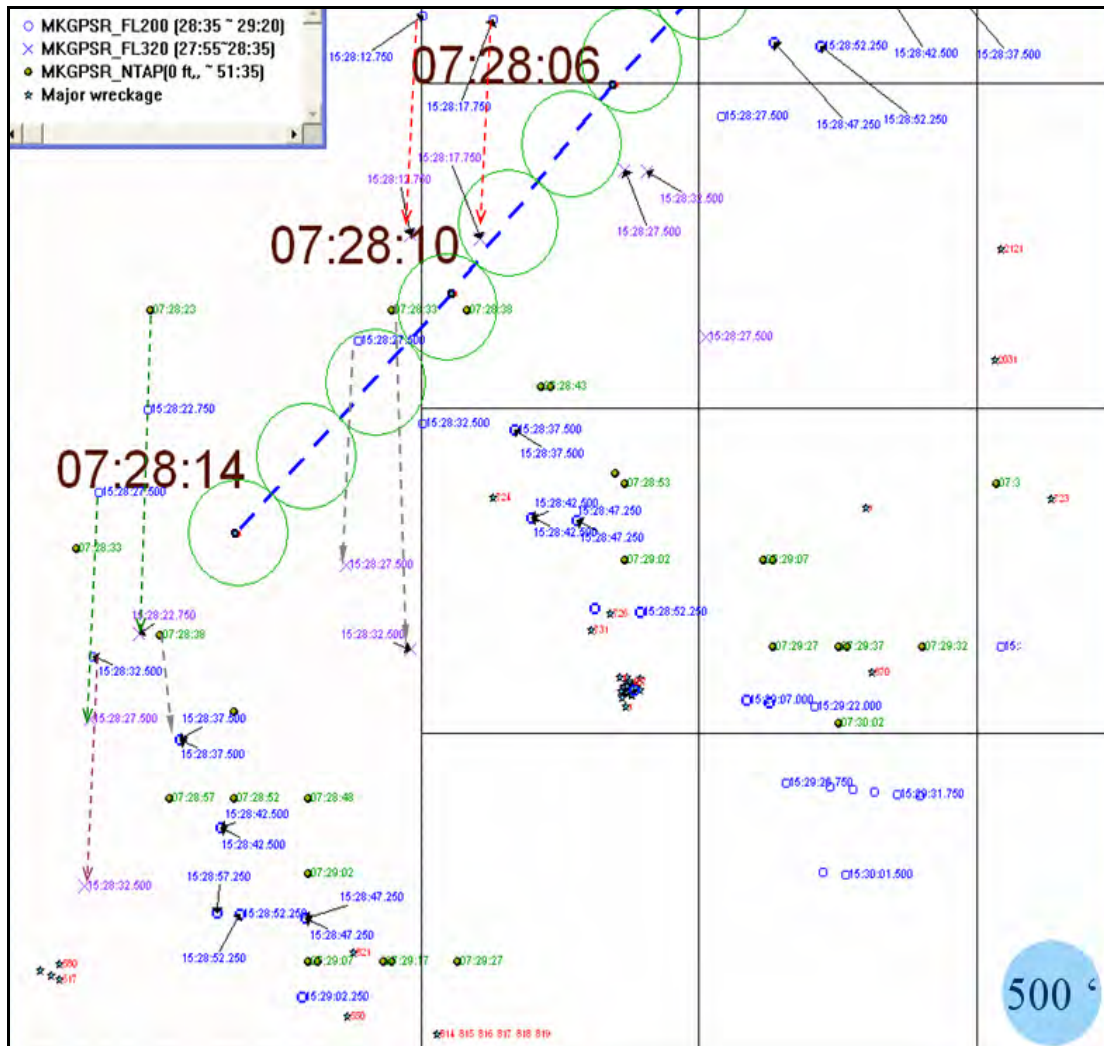

Figure 2.9-2 SSR track, PSR returns with altitude correction (yellow, green zones)

Before correction, there were no relevant PSR returns within 1,500 ft of the recovered positions of engines #1, #2, and the main wreckage field. Figure 2.9-3 shows the superposition of the PSR returns, SSR track from 1526:39 to 1528:14, and positions of major wreckage.

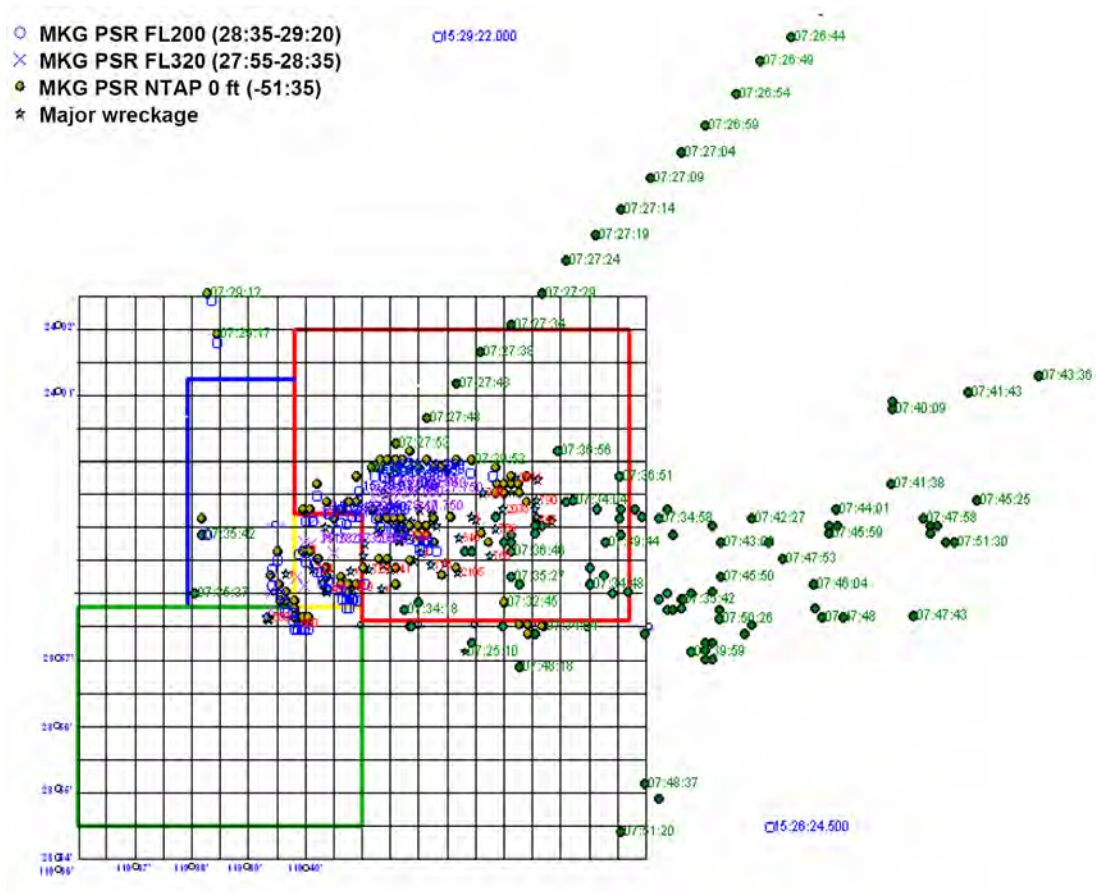

Figure 2.9-3 SSR track, PSR returns and position of major wreckage

### 2.9.3 Ballistic Trajectory of the Wreckage Pieces

It should be noted that since it is impossible to obtain the attitude of the wreckage pieces during descent, one could only assume constant ballistic coefficients for this analysis. Thus, the ballistic analysis can only be used as reference information to support the breakup of CI611.

#### 2.9.3.1 Introduction

Ballistic trajectory analysis is applied to selected wreckage pieces salvaged to assist the determination of the breakup sequence<sup>47</sup>. Trajectory of a wreckage

<sup>47</sup>(a) John C. Clark, "Trajectory Study," National Transportation Safety Board, Bureau of Technology, Washington, DC, July 12, 1985.

piece is traced with a time step simulation from its initial conditions to the position of that piece when recovered from the seabed. The initial condition is described with six parameters; positions (East, North, and Altitude), airspeed, flight path angle and heading.

The ballistic trajectory of a wreckage piece can be calculated based on its mass and aerodynamic characteristics, or the Ballistic Coefficient (BC). BC is the function of the mass, aerodynamic drag, and its effective cross section area. From the recovered wreckage piece, specific BC can be assumed. The ballistic trajectory of that wreckage piece can then be computed based on the wind profile, its BC, and an assumed initial condition. The computed trajectory will then be compared with the wreckage-salvaged position. Trajectory with higher BC will asymptotically approach its initial heading of the wreckage object. Trajectory with lower BC would asymptotically follow the wind drift. Thus, for the pieces with higher BC, the trajectory matching to the recovery location would be more accurate.

### **2.9.3.2 Ballistic Trajectory Analysis for CI611**

The wreckage distribution showed that wreckage pieces were initially separated from the aft section of the accident aircraft. The Safety Council selects the major items in the red zone, main wreckage, and the engines for the ballistic analysis.

Ballistic trajectories are determined using the Ballistic program, developed by the NTSB. It has been used successfully for many years<sup>48</sup>.

Dynamic Model of the ballistic trajectory is given as follows:

---

<sup>47</sup>(b) Hugh Oldham, "Aircraft Debris Trajectory Analysis," 304 Lyonswood Drive Anderson, South Carolina 29624, August 21, 1990.

<sup>48</sup> Aviation Accident Report: In-flight Breakup Over the Atlantic Ocean Trans World Airlines Flight 800 Boeing 747-141, N93119 near East Moriches, New York July 17, 1996. Report Number: AAR-00-03.

$$\begin{aligned}
\dot{V}_x &= -\frac{Dg}{W} \cos \gamma \sin \psi + a_x = -\frac{\rho V^2}{2BC} g \cos \varphi \sin \psi + a_x \\
\dot{V}_y &= -\frac{Dg}{W} \cos \gamma \cos \psi + a_y = -\frac{\rho V^2}{2BC} g \cos \varphi \cos \psi + a_y \\
\dot{V}_z &= \frac{Dg}{W} \sin \gamma - g + a_z = -\frac{\rho V^2}{2BC} g \cos \varphi \sin \psi - g + a_z \qquad \text{Eq. (1)} \\
BC &= \frac{W}{CD * S}; \quad D = 0.5 \rho V^2; \quad \gamma = \tan^{-1}\left(-\frac{V_z}{V_{xy}}\right); V_{xy} = \sqrt{V_x^2 + V_y^2} \\
\rho &= 0.002378e^{-z/30000}, y < 30000 \text{ ft}; \quad \rho = 0.0034e^{-z/22000}, y \geq 30000 \text{ ft}
\end{aligned}$$

$$\begin{aligned}
\dot{X} &= \int \dot{V}_x dt + V_w \cos \psi_w (h) \\
\dot{Y} &= \int \dot{V}_y dt + V_w \sin \psi_w (h) \qquad \text{Eq. (2)} \\
\dot{Z} &= \int \dot{V}_z dt
\end{aligned}$$

Symbols of D and W denote the aerodynamic drag and weight of ballistic object.  $\rho$  represents air density,  $a_x$ ,  $a_y$ , and  $a_z$  are longitudinal, lateral and vertical un-modeled accelerations along the 3-axes position variables of X, Y and Z, respectively. These un-modeled accelerations are assumed to be zero for this study. Symbols of S and CD represent the reference area of a ballistic object and zero-lift drag coefficient. Terminal velocity is defined as the point at which aerodynamic drag equals the weight of the ballistic object, so that it produces zero acceleration along the Z-axis. After integrating equation (1) in time, and inputting the wind profile, the 3-axes position variables in equation (2) can be obtained. Applying the initial position and integrating equation (2), the ballistic trajectory of the wreckage piece can then be obtained.

The last recorded altitude, airspeed, and heading parameter values by the FDR and the time of the last transponder returns are used as the known initial conditions of the simulation. The program outputs a three-dimensional trajectory of the specific wreckage object when it hits water. The unknown initial position was then obtained by translating the final coordinates of the trajectory to match the coordinates of the wreckage object recovered.

Section 2.9.3.4 shows the result of ballistic trajectories, indicating that the red zone pieces separated from the accident aircraft in the first few seconds after the flight recorders lost their power. Since the main fuselage and engines were all very heavy items with high inertia, their airspeed and heading are assumed to be



constant. In order to evaluate the timing of the engine separation from the forward body, a specific initial condition was assumed that the forward body was still at high altitude. The damaged aircraft could undergo a very erratic attitude change that may cause the separation of those engines. However, due to its extremely dynamic nature, no attempt was made by the Safety Council to calculate the force required to separate the engines from the main fuselage after the initial breakup of the aircraft.

### **2.9.3.3 Error Sources**

There are several sources of error in the ballistic trajectory analysis that should be taken into account when interpreting the results. These error sources are: accuracies of the SSR data, wreckage salvaged position, uncertainties in the estimation of the wreckage weight, aerodynamic drag coefficient, the wind profile, buoyancy and ocean currents.

Accuracy of the SSR data is as follows:

- Makung radar: Cross Area  $> 2\text{m}^2$ ; Separation range:  $\pm 1/8$  NM ( $\pm 760\text{ft}$ ); min. strength  $> -104$  dB
- Long range radar: Cross Area  $> 2\text{m}^2$ ; Separation range: 1000ft;
- Alt error: slant range greater 150 NM,  $\pm 1000 \times (\text{slant range}/150)^3$  ft

Accuracy of the wreckage-salvaged position is as follows:

- GPS and ROV, better than 50 ft.

The ballistic trajectory analysis assumes that the wreckage pieces fell with a constant BC from the moment of separation from the aircraft main body. In fact, wreckage orientation during descent was nearly impossible to predict. During initial separation, dynamic forces on the wreckage would result in an initial separation condition from a pure ballistic trajectory for a period, which could induce an error of the final descent point. Furthermore, the ballistic trajectory generated did not consider the possible sub-separations of the wreckage pieces. Ballistic trajectory analysis also assumes that wreckage objects separated from the main fuselage with initial airspeed and heading equal to the last recorded flight condition.

The accuracy of wind profiles would also impact the accuracy of the results. The

wind profile would affect the initial positions of the wreckage items, and may also affect their sequence of separation during the rapid descent. Wind profile used in the ballistic trajectory analysis was described in section 1.11.3. These winds were interpolated to even altitudes from upper air data contained in the meteorological information of section 1.7.

The estimated drift effect of ocean current does not take into account the effect of buoyancy<sup>49</sup>. Ocean depth at the accident site is about 230 ft. The ocean current at the time of the accident was predicted by NCOR to be 2.5 knots to 5.0 knots, northern direction. It is desirable to determine the drift effect of the current on wreckage locations. Figures 2.9-4 shows the relationships of drift distance and different ballistic coefficients (BC). The drift effect of ocean currents on heavy wreckage position (BC greater than 10) is less than 500 ft; 1,000 ft to 2,000 ft for the lighter wreckage (BC less than 10).

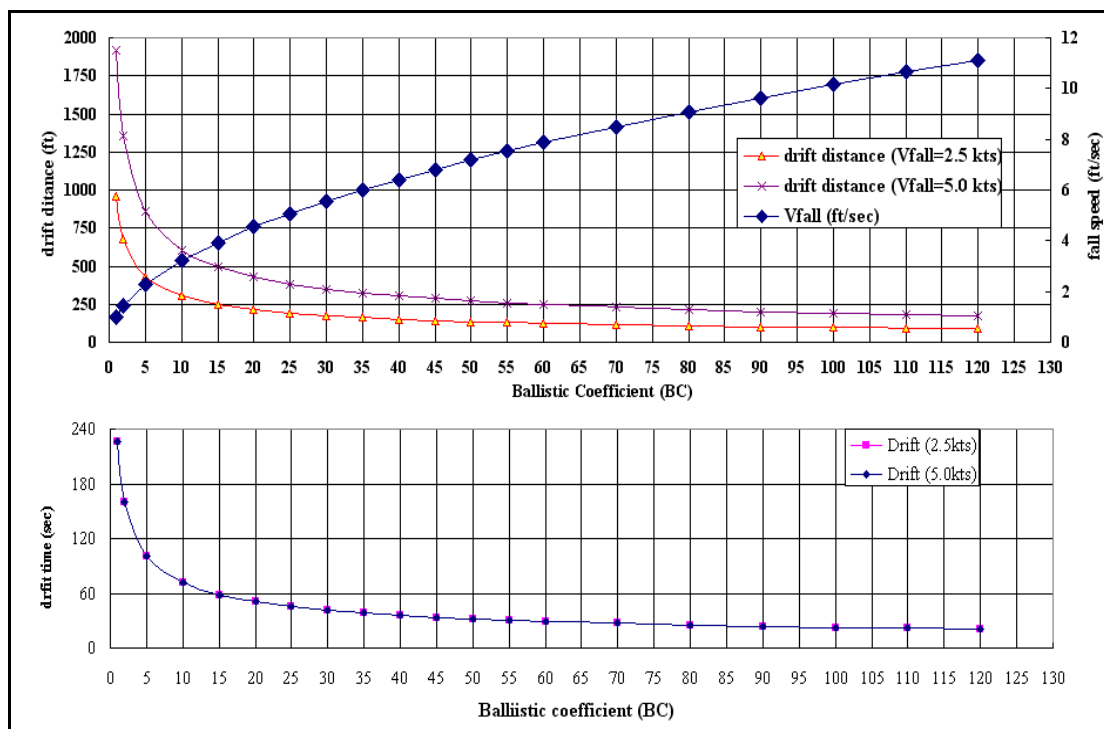

Figure 2.9-4 Comparison of drifting distance on the wreckage of different ballistic coefficients

<sup>49</sup> Buoyancy effect: Buoyancy is the upward force exerted on an object when it is immersed, partially or fully, in a fluid (air or water). All objects that are surrounded by air or water on the surface of the Earth experience buoyancy to some degree. For example, two parts may have the same ballistic coefficient and same weight, but if one contains a trapped airspace while the other does not, the effect of the ocean currents could be significantly different.

### 2.9.3.4 Results

There were 18 pieces of wreckage analyzed, for which the initial breakup was assumed to have occurred at 1528:03, 34,900 ft, 287 knots, +3 deg flight path angle, and 220 deg heading. Those 18 pieces separated into four groups; the first group of plots indicates the trajectories of engines; the second group of plots shows the trajectory of the main forward body; the third group of plots shows the trajectories of the aft cargo door, the empennage, and the recorders; the fourth group of plots indicates the trajectories of the wreckage recovered in the red zone.

Table 2.9-1 summaries the ballistic trajectories in the red zone, the main forward body (including cockpit), tail section and engines. ID numbers of wreckage pieces, Impact time, ballistic coefficients and estimated wreckage weight are also included.

Superposition of the ballistic trajectories, the SSR transponder returns, the PSR returns, and wreckage-salvaged position are shown in Figures 2.9-5 and 2.9-6.

Table 2.9-1 Summary of ballistic trajectories

Wreckage ID	Trajectory at sea level	Ballistic Coefficient	Weight (lb)	Wreckage description
ENG 1&2	0729:12	280.00	14050	Engine 1&2
ENG 3&4	0729:18	220.00	13986	Engine 3&4
Cockpit	0730:34	45.00	361100-400400	Cockpit
1201	0735:59	3.80		STA 1940-2040 skin (2.4m×1.2m)
1281/1282	0739:44	1.75	75	Portion of frame and skin of section 46 (4m×1.7m)
2011	0738:01	2.40		STA 1900-2080 skin of LHS section 46 with 9 windows
2030	0734:58	5.00		STA 1480-1741 skin with door
2034	0733:33	8.00		Door 5R
630	0732:01	15.00	16000-24000	Tail
640	0734:54	5.00	774	Bulk cargo door
723	0731:36	20.00		Upper part of after cargo door
738	0736:23	3.20	399	Large piece of skin with STA 1460 door frame with Door L4 and 13 windows (10m×5m)

Wreckage ID	Trajectory at sea level	Ballistic Coefficient	Weight (lb)	Wreckage description
740/767	0736:21	2.10	10.5	After cargo door lower lobe frame (2m×0.5m) skin with "B18255" painting mark (6m×2.5m)
741	0733:01	10.00	777	After cargo door lower lobe skin attached with door (5m×4m×0.5m)
751	0732:20	13.00	539	Door L5 in section 46 8m×2m
768	0736:23	2.00	395	STA 1680-1930 skin with 11 windows near Door R4 (3m)
789	0736:22	2.00		STA 2230-2340 skin
870	0731:15	25.00		STA 1600-1720 cabin floor (3.4m×3.2m)

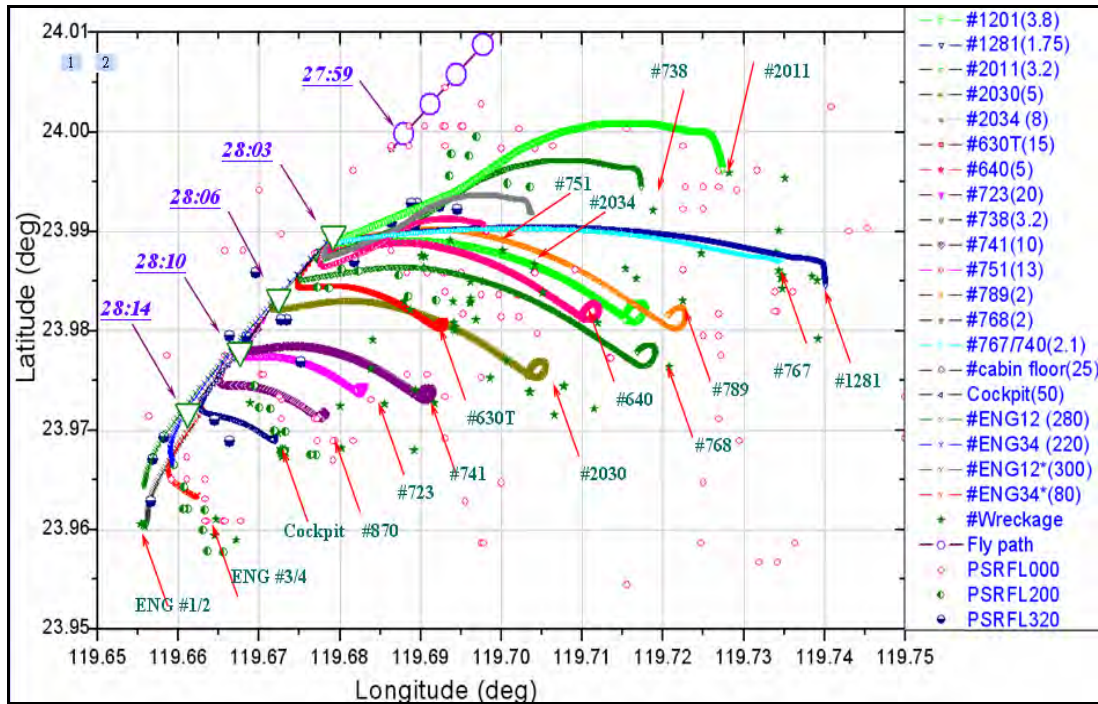

Figure 2.9-5 Two-Dimensional plot of ballistic trajectories

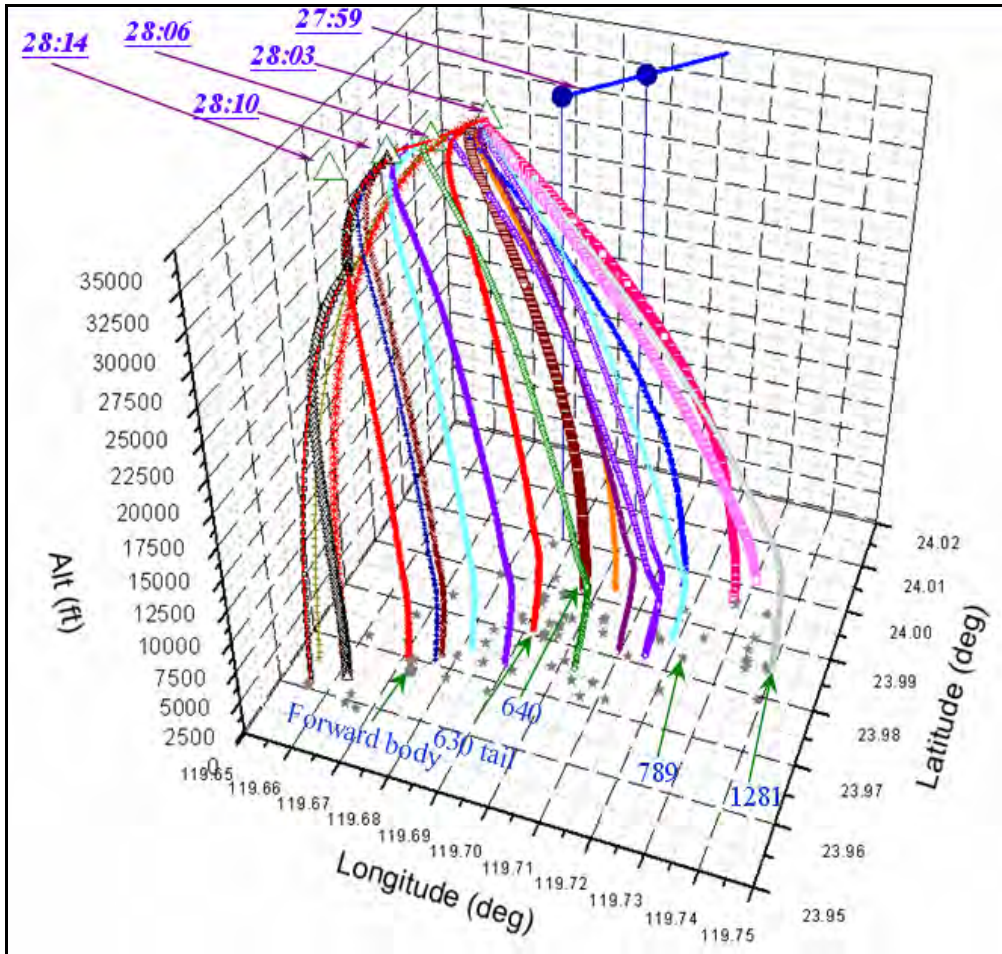

Figure 2.9-6 Three-Dimensional plot of ballistic trajectories

The ballistic analysis indicated that initial breakup of CI611 may have occurred more than 4 seconds after the ending of the FDR recording for all or some of the segments. Larger segments may have separated into smaller segments after the initial breakup. It should be re-emphasized that partial lift and buoyancy effects were not taken into account in the analysis.

The analysis results showed that the main forward body descended to sea level at 1530:34. The engines descended to sea level about 1529:15. The initial condition of assuming the engines separated from the main forward body at FL290 yields resulting trajectories closest to the salvaged positions of the four engines.

All the ballistic trajectories were consistent with the salvaged wreckage positions. The average distance error is less than 1,000 ft. Figure 2.9-7 (denoted as blue and green) shows the superposition of ballistic trajectories, SSR track, PSR returns, Doppler weather radar trajectory, and airborne debris distribution. Two

trajectories using different wind profiles with the same breakup initial condition (BC assumed to be 0.28). These trajectories indicated that airborne debris initiated descent at the altitude about 35,000 ft. Doppler radar trajectories and the recovered location of those light pieces of debris match with the computed ballistic trajectory.

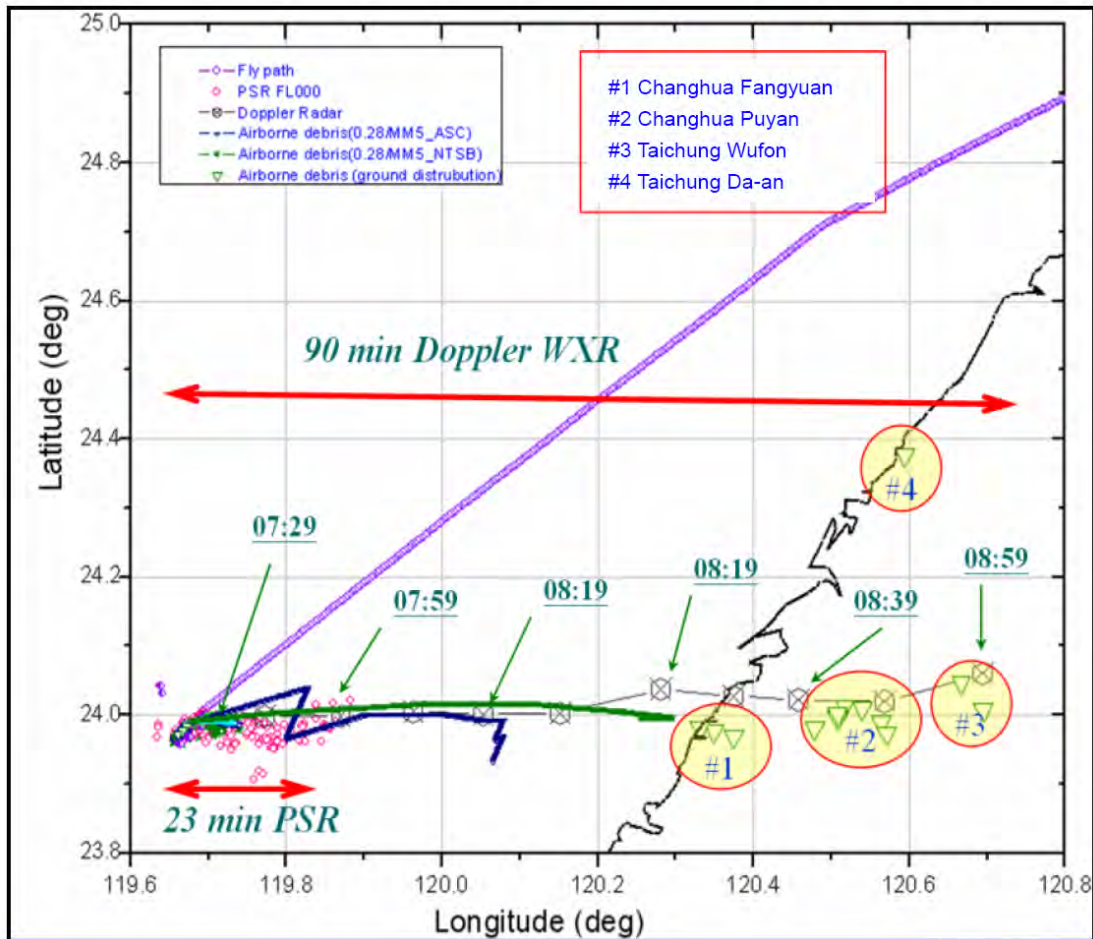

Figure 2.9-7 2D ballistic trajectories, SSR, PSR returns, and airborne debris

### 2.9.4 Higher Accuracy Tracking Radar

The ballistic analysis could be accomplished with better accuracy and in a timelier manner for the salvage operation had the better accuracy tracking radar data been available. It is worthy to note that in the United States, the NTSB has an agreement with its Department of Defense to obtain military and intelligence-gathering ground-based and airborne radar data, as well as satellite data, if available. Plots of data from such sources, if it contains information about an aircraft accident, are provided to the NTSB without compromising the classified nature of the source. For example, when the cargo door separated

from the UAL Boeing 747 Flight 811 100 miles from Hawaii, US military height-finding radar were used to plot the descent of the door and other pieces of wreckage. Those data were used to eventually search for and recover the remains of the cargo door from the deep ocean. If tracking radar data were available, it would have made the task of evaluating the breakup and final descent of the wreckage pieces more accurate.

**Intentionally left blank**



## 3. Conclusions

In this Chapter, the Safety Council presents the findings derived from the factual information gathered during the investigation and the analysis of the CI611 accident.

The findings are presented in three categories: findings related to probable causes, findings related to risk, and other findings.

**The findings related to the probable causes** identify elements that have been shown to have operated in the accident, or almost certainly operated in the accident. These findings are associated with unsafe acts, unsafe conditions, or safety deficiencies that are associated with safety significant events that played a major role in the circumstances leading to the accident.

**The findings related to risk** identify elements of risk that have the potential to degrade aviation safety. Some of the findings in this category identify unsafe acts, unsafe conditions, and safety deficiencies that made this accident more likely; however, they can not be clearly shown to have operated in the accident. They also identify risks that increase the possibility of property damage and personnel injury and death. Further, some of the findings in this category identify risks that are unrelated to the accident, but nonetheless were safety deficiencies that may warrant future safety actions.

**Other findings** identify elements that have the potential to enhance aviation safety, resolve an issue of controversy, or clarify an issue of unresolved ambiguity. Some of these findings are of general interest and are not necessarily

analytical, but they are often included in ICAO format accident reports for informational, and safety awareness, education, and improvement purposes.

### **3.1 Findings Related to Probable Causes**

1. Based on the recordings of CVR and FDR, radar data, the dado panel open-close positions, the wreckage distribution, and the wreckage examinations, the in-flight breakup of CI611, as it approached its cruising altitude, was highly likely due to the structural failure in the aft lower lobe section of the fuselage. (1.8, 1.11, 1.12, 2.1, 2.2, 2.6)
2. In February 7 1980, the accident aircraft suffered a tail strike occurrence in Hong Kong. The aircraft was ferried back to Taiwan on the same day un-pressurized and a temporary repair was conducted the day after. A permanent repair was conducted on May 23 through 26, 1980. (1.6, 2.3)
3. The permanent repair of the tail strike was not accomplished in accordance with the Boeing SRM, in that the area of damaged skin in Section 46 was not removed (trimmed) and the repair doubler did not extend sufficiently beyond the entire damaged area to restore the structural strength. (1.6, 1.16, 2.3)
4. Evidence of fatigue damage was found in the lower aft fuselage centered about STA 2100, between stringers S-48L and S-49L, under the repair doubler near its edge and outside the outer row of securing rivets. Multiple Site Damage (MSD), including a 15.1-inch through thickness main fatigue crack and some small fatigue cracks were confirmed. The 15.1-inch crack and most of the MSD cracks initiated from the scratching damage associated with the 1980 tail strike incident. (1.16, 2.2)
5. Residual strength analysis indicated that the main fatigue crack in combination with the Multiple Site Damage (MSD) were of sufficient magnitude and distribution to facilitate the local linking of the fatigue cracks so as to produce a continuous crack within a two-bay region (40 inches). Analysis further indicated that during the application of normal operational loads the residual strength of the fuselage would be compromised with a continuous crack of 58 inches or longer length. Although the ASC could not determine the length of cracking prior to the accident flight, the ASC believes that the extent of hoop-wise fretting marks found on the doubler,

and the regularly spaced marks and deformed cladding found on the fracture surface suggest that a continuous crack of at least 71 inches in length, a crack length considered long enough to cause structural separation of the fuselage, was present before the in-flight breakup of the aircraft. (2.2, 2.5)

6. Maintenance inspection of B-18255 did not detect the ineffective 1980 structural repair and the fatigue cracks that were developing under the repair doubler. However, the time that the fatigue cracks propagated through the skin thickness could not be determined. (1.6, 2.3, 2.4)

### **3.2 Findings Related to Risk**

1. The first Corrosion Prevention and Control Program (CPCP) inspection of the accident aircraft was in November 1993 making the second CPCP inspection of the lower lobe fuselage due in November 1997. CAL inspected that area 13 months later than the required four-year interval. In order to fit into the CAL maintenance schedule computer control system, CAL estimated the average flight time or flight cycles for each aircraft and scheduled the calendar year based inspection. Reduced aircraft utilization led to the dates of the flight hour inspections being postponed, thus the corresponding CPCP inspection dates were passed. CAL's oversight and surveillance programs did not detect the missed inspections. (1.6, 2.4)
2. According to maintenance records, starting from November 1997, B-18255 had a total of 29 CPCP inspection items that were not accomplished in accordance with the CAL AMP and the Boeing 747 Aging Airplane Corrosion Prevention & Control Program. The aircraft had been operated with unresolved safety deficiencies from November 1997 onward. (1.6, 2.4)
3. The CPCP scheduling deficiencies in the CAL maintenance inspection practices were not identified by the CAA audits. (1.6, 1.18, 2.4)
4. The determination of the implementation of the maximum flight cycles before the Repair Assessment Program was based primarily on fatigue testing of a production aircraft structure (skin, lap joints, etc.) and did not take into account of variation in the standards of repair, maintenance, workmanship and follow-up inspections that exist among air carriers. (1.6, 1.17, 1.18, 2.4)

5. Examination of photographs of the item 640 repair doubler on the accident aircraft, which was taken in November 2001 during CAL's structural patch survey for the Repair Assessment Program, revealed traces of staining on the aft lower lobe fuselage around STA 2100 were an indication of a possible hidden structural damage beneath the doubler. (1.6, 2.2)
6. CAL did not accurately record some of the early maintenance activities before the accident, and the maintenance records were either incomplete or not found. (1.6, 2.4)
7. The bilge area was not cleaned before the 1st structural inspection in the 1998 MPV. For safety purpose, the bilge area should be cleaned before inspection to ensure a closer examination of the area. (1.6,2.4)

### **3.3 Other Findings**

1. The flight crew and cabin crewmembers were properly certificated and qualified in accordance with applicable CAA regulations, and CAL company requirements. (1.5,2.1)
2. This accident bears no relationship with acts or equipment of the air traffic control services. (2.1)
3. This accident bears no relationship with the actions or operations by the flight crew or cabin crewmembers. (1.1, 1.5, 2.1)
4. The possibilities of a midair collision, engine failure or separation, cabin over pressurization, cargo door opening, adverse weather or natural phenomena, explosive device, fuel tank explosion, hazardous cargo or dangerous goods, were ruled out as potentials of this in-flight breakup accident. (1.10,1.11,1.12,1.13,1.16, 2.1)
5. There was no indication of penetration of fragments, residual chemicals, or burns that could be associated with a high-energy explosion or fire within the aircraft. (1.13, 1.14, 1.15, 2.1, 2.8)
6. The reasons for the unexpected position of some of the cockpit switches were undetermined. They might have been moved intentionally or may have been moved as the result of breakup, water impact, and wreckage recovery or transportation. (1.12, 1.16, 2.7)

7. Based on time correlation analysis of the Taipei Air Control Center air-ground communication recording and the CVR and FDR recordings, the CVR and FDR stopped recording simultaneously at 1527:59. (1.11, 2.6)
8. Except the very last sound spectrum, all other sounds from the CVR recording yielded no significant information related to this accident. (1.11, 2.6)
9. The sound signature analysis of the last 130 milliseconds CVR recording, as well as the power of both recorders been cut-off at the same time, revealed that the initial structural breakup of CI611 was in the pressurized area. (1.11, 2.6)
10. The last three Mode-C altitude data recorded by Xiamen radar between 1528:06 and 1528:14, most likely were inaccurate measurements because of the incorrect sensing of the static pressure tubes affected by severe aircraft maneuvering. (1.11, 2.9)
11. The ballistic analysis, although with assumptions, supports that the in-flight breakup of CI611 aircraft initiated from the lower lobe of the aft fuselage. Several conclusions can be drawn from the analysis: (1.11, 2.9)
  - Some segments might have broken away more than 4 seconds after power loss of the recorders. Several larger segments might have separated into smaller pieces after the initial breakup.
  - The engines most likely separated from the forward body at FL290 about 1528:33.
  - Airborne debris (papers and light materials) from the aft fuselage area, departed from the aircraft about 35,000 ft altitude, and then traveled more than 100 km to the central part of Taiwan.
12. If tracking radar data could be made available to both the salvage operation and accident investigations, the salvage operation could be accomplished in a timelier manner and the ballistic analysis would yield better accuracy. (1.12, 2.9)
13. There is no lighting standard for CAL during a structural inspections and the magnifying glass was not a standard tool for structural inspections. (1.6,2.4)
14. There was a problem in communication between Boeing Commercial Airplane Company and CAL regarding the tail strike repair in 1980. The

Boeing Field Service Representative would have seen the scratches on the underside of the aircraft. However, the opportunity to provide expert advice on a critical repair appears to have been lost, as there are no records to show that the FSR had a role in providing advice on the permanent repair. (1.17, 2.3)

15. As demonstrated in the case of CI611, the accident aircraft had a serious hidden structural defect. High frequency eddy current inspection is not able to detect cracks through a doubler. The crack would still not be detected if external high frequency eddy current had been used for structure inspection. Therefore, a more effective non-destructive structural inspection method should be developed to improve the capability of detection of hidden structural defects. (1.16, 2.4)
16. Due to the oriental culture and lack of legal authority to request autopsy, the autopsy was conducted only on the three flight crewmembers. (1.13, 2.8)

## 4. Safety Recommendations

In this chapter, safety recommendations derived as the result of this investigation are listed in Section 4.1. Safety actions that have been accomplished, or are currently being planned by the stakeholders as the result of the investigation process are listed right after the recommendations or in Section 4.2. It should be noted that the Safety Council has not verified the safety actions. Therefore, the Safety Council is still listed those recommendations even they have already been implemented.

### 4.1 Recommendation

#### 4.1.1 Interim Safety Bulletin (ASC-ISB-003-001)

In 21 March 2003, the Safety Council issued the following Interim Flight Safety Bulletin to ICAO<sup>50</sup>:

**Subject: Aircraft Pressure Vessel Structure Repair Alert**

#### **Background Information:**

On May 25, 2002, a Boeing 747-200 aircraft, owned and operated by China Airlines, crashed in the Taiwan Strait during a scheduled flight from Taipei to

---

<sup>50</sup> A Chinese version of Interim Flight Safety Bulletin was issued to CAA ROC.

Hong Kong. The Aviation Safety Council (ASC) of Taiwan has been conducting the investigation. The investigation is still in progress and the probable causal factors not determined. However, based on the factual information collected to date, the ASC has identified a safety issue that should be addressed.

#### **Interim Safety Recommendation:**

The ASC strongly recommends that all civil aviation accident investigation agencies to collaborate with their regulatory authorities to take appropriate action requiring all operators of transport-category aircrafts with pressure vessel repairs. Identified as a result of structural damage other than those covered by Boeing service bulletin documentation ASB B747-53A2489 for an immediate inspection on the repaired area to determine whether any hidden damage is present.

An improperly treated scratch on the aircraft pressure vessel skin, especially if covered under a repair doubler, could be a hidden damage that might develop into fatigue crack eventually causing structure failure.

### **4.1.2 Safety Recommendations**

#### **To China Airlines**

1. Perform structural repairs according to the SRM or other regulatory agency approved methods without deviation, and perform damage assessment in accordance with the approved regulations, procedures, and best practices. (1.6, 2.3,2.4)-ASC-ASR-05-02-001

#### **CAL response:**

CAL accomplished Boeing Service Bulletin (SB) B747-53A2489 (747 Fuselage - Skin - Lower Body Skin Inspection from STA 1961 to STA 2360) on March 6th, 2003 in accordance with an advance telex from Boeing.

CAA concurred with the CAL publication of QP 12ME009 dated August 7th 2003 to re-examine all previous patch repairs on the aircraft pressure boundary for the whole fleet, in response to CAA AD 2003-03-020A dated April 30th 2003.

QP 12ME009 specifies EO (Engineering Order) documentation for pressure



boundary repair. The current repair EO must include:

- Warning wording: “Hidden structural damage can cause aircraft structure failure”;
- Categorization of the repair as “major” (QR 8.1.3 issue 8 dated August 1st 2004);
- Complete defect type and location description;
- Step by step instructions and signature requirements;
- A detailed drawing showing the extent and nature of damage, its location on the aircraft, doubler dimensions, material specification (including fasteners), applicable SRM section, and any special instructions;
- RII (Required Item Inspection) specified for the repair.

For structural repairs that are classified as RII, inspectors must follow “Duplicate Inspections on Aircraft and Aircraft Components, QR 8.1.5 Issue No. 6”, dated December 1st 2003, and “QP 08MI043 Issue No. 5”, dated August 31st 2004; inspectors must review work sheets in advance, and conduct inspections both during the repair process and after completion to ensure a damage free condition and compliance with maintenance processes specified in the SRM procedures.

For any structural damage beyond existing approved data, CAL must seek assistance and consultation from the manufacturer(s) for appropriate repair procedures.

2. Review the record keeping system to ensure that all maintenance activities have been properly recorded. (1.6, 2.4) -ASC-ASR-05-02-002

CAL response:

CAL has revised QP12MI002 (Rev.2 dated July 30th 2004) in accordance with AC 43-001A issued by the CAA (dated May 19th, 2004) for Maintenance Record Keeping; notably, structural repair records are to be retained in accordance with CAA regulations and an additional copy of the major repair record will be specifically archived to establish a historical structural record for each aircraft on all fleets.

3. Assess and implement safety related airworthiness requirements, such as

the RAP, at the earliest practicable time. (1.6, 2.4) -ASC-ASR-05-02-003

CAL response:

Currently, CAL has scheduled early implementation of CPCP tasks on all affected 747- 400 airplanes.

4. Review the self-audit inspection procedures to ensure that all the mandatory requirements for continuing airworthiness, such as CPCP, are completed in accordance with the approved maintenance documents. (1.6, 2.4) -ASC-ASR-05-02-004

CAL response:

- a. CAL has changed the philosophy of control for planned maintenance tasks that do not correspond with the intervals of letter checks. The relevant data has been reviewed and transferred to a computer system so that such tasks can be controlled by an automatic system in accordance with the aircraft maintenance program. Thus, a basic (first level) self-audit system has been established with the aid of an automatic computer system. Implementation of this control methodology commenced before April 30th, 2004.
  - b. CAL EMD established a dedicated department, Engineering Planning Department (EPD), on May 10th 2004, to integrate such functions as planning, control, issuance of work orders, monitoring, etc. to ensure the overlap integrity of various tasks.
  - c. In accordance with CAA requirements, a check form (QP08MI052F1R0) originated from CAA, – form FSD-AWS-D-001 – was developed on June 15th, 2004 to ensure that all the mandatory requirements for continuing airworthiness are completed in accordance with the approved maintenance documents. Columns for the conformity of maintenance task planning and execution will be signed by an authorized person following review.
  - d. The Quality management Office will conduct a yearly audit of EPD to monitor its operational effectiveness.
5. Enhance maintenance crew's awareness with regard to the irregular shape of the aircraft structure, as well as any potential signs that may indicate hidden structural damage. (1.6, 2.2) -ASC-ASR-05-02-005

CAL response:

- a. As there is no existing visual inspection methodology that uses the liquid trace phenomenon to detect the structural anomalies, the case study of the CI-611 accident will be put into the training program by the CAL Technical Training Office, to instruct maintenance crew on how to detect hidden structural damage which results in irregular shape of the aircraft surface or visible liquid traces or stains. The OJT (On-the-Job Training) was conducted prior to August 1st, 2004. It includes discussion with maintenance crews of the indication(s) of possible hidden damage as shown in the photographs of the CI-611 doubler area. The formal training material was set up on July 30th 2004 by the CAL Technical Training Office.
  - b. The Aircraft Inspection Section issued an "Inspection Circular" using the CI-611 accident as a case study to instruct inspectors on how to recognize early indications of hidden structural damage on July 27th 2004; Advanced OJT has been, and will continue to be, conducted periodically by the Aircraft Inspection Section on a randomly scheduled, as-necessary basis, on maintenance inspection subjects that are necessary for inspectors to know. The Advanced OJT may be conducted by issuance of Inspection Circulars or provision of in-situ inspection guidance by the Foreman or Duty Manager.
6. Re-assess the relationship with the manufacturer's field service representative to actively seek assistance and consultation from manufacturers' field service representatives, especially in maintenance and repair operations (1.6, 2.3) -ASC-ASR-05-02-006

CAL response:

CAL currently enjoys the benefit of a strong and communicative relationship with the manufacturer field service representatives from both Boeing and Airbus; both have proven cooperative and responsive to requests for technical support by the airline.

**To Civil Aeronautics Administration, ROC**

1. Ensure that all safety-related service documentation relevant to ROC-registered aircraft is received and assessed by the carriers for safety

of flight implications. The regulatory authority process should ensure that the carriers are effectively assessing the aspects of service documentation that affect the safety of flight. (1.6, 1.17, 2.4) -ASC-ASR-05-02-007

2. Consider reviewing its inspection procedure for maintenance records. This should be done with a view to ensuring that the carriers' systems are adequate and are operating effectively to make certain that the timeliness and completeness of the continuing airworthiness programs for their aircraft are being met. (1.6, 1.17, 2.4) -ASC-ASR-05-02-008
3. Ensure that the process for determining implementation threshold for mandatory continuing airworthiness information, such as RAP, includes safety aspects, operational factors, and the uncertainty factors in workmanship and inspection. The information of the analysis used to determine the threshold should be fully documented. (1.18, 2.2, 2.4) -ASC-ASR-05-02-009
4. Encourage operators to establish a mechanism to manage their maintenance record keeping system, in order to provide a clear view for inspector/auditors conducting records reviews. (1.6, 2.4) -ASC-ASR-05-02-010
5. Encourage operators to assess and implement safety related airworthiness requirements at the earliest practicable time. (1.6, 2.4) -ASC-ASR-05-02-011
6. Consider the implementation of independent power sources for flight recorders and dual combination recorders to improve the effectiveness in flight occurrence investigation. (1.11, 2.6) -ASC-ASR-05-02-012
7. Consider adding cabin pressure as one of the mandatory FDR parameter. (1.12, 2.7) -ASC-ASR-05-02-013
8. Closely monitor international technology development regarding more effective non-destructive inspection devices and procedure. (1.6, 2.2, 2.4) -ASC-ASR-05-02-014

### **To Boeing Commercial Airplane Company**

1. Re-assess the relationship of Boeing's field service representative with the operators such that a more proactive and problem solving consultation effort to the operators can be achieved, especially in the area of maintenance

operations. (2.2, 2.3) -ASC-ASR-05-02-015

Boeing response:

The ASC recommends that Boeing reassess the role of the field service representative such that a more pro-active and problem solving consultative effort can be achieved. In 1999, Boeing undertook an extensive reevaluation of the role of our field service representatives. This reevaluation did not change the technical support role of our representatives, but rather expanded the role to emphasize consultative support on larger and more forward-looking issues as listed below.

- A greater emphasis with airline management concerns involving complex technical and business issues
- Advising customer personnel regarding cost of airplane ownership, safety issues, and operational efficiency
- Facilitating changes to Boeing-recommended maintenance procedures, operational procedures, or designs in response to technical and operational problems observed at operators
- Above all, strive to recognize problems and trends before they have an adverse impact on safety

We believe these changes, already in place, meet the intent of the ASC recommendation.

2. Develop or enhance research effort for more effective non-destructive inspection devices and procedures. (1.6,2.2,2.4) -ASC-ASR-05-02-016

Boeing response:

Boeing's NDI staff researches and develops for operator use new non-destructive inspection methods and tools that incorporate technological advances and accommodate evolving inspection needs. For example, new ultrasonic methods and tool were developed to assist operators with the inspection of repairs associated with tail strikes in accordance with Service Bulletin 747-53A2489. These Boeing NDI research and development efforts will continue.

**To the Federal Aviation Administration (FAA) of the U.S.**

1. Consider the implementation of independent power sources for flight recorders and dual combination recorders to improve the effectiveness in flight occurrence investigation. (1.11, 2.6) -ASC-ASR-05-02-017
2. Consider adding cabin pressure as one of the mandatory FDR parameter. (1.12, 2.7) -ASC-ASR-05-02-018
3. Ensure that the process for determining implementation threshold for mandatory continuing airworthiness information, such as RAP, includes safety aspects, operational factors, and the uncertainty factors in workmanship and inspection. The information of the analysis used to determine the threshold should be fully documented. (1.18, 2.2, 2.4) -ASC-ASR-05-02-019

**To Aviation Safety Council, Ministry of National Defense, and Ministry of Justice**

1. ASC should coordinate with the Ministry of Defense to sign a Memorandum of Agreement for the utilization of the defense tracking radar information when necessary, to improve efficiency and timeliness of the safety investigations. (1.11, 2.8) -ASC-ASR-05-02-020
2. ASC should coordinate with the Ministry of Justice to develop an autopsy guidelines and procedures in aviation accident investigation. (1.13, 2.8) -ASC-ASR-05-02-021

## 4.2 Safety Actions Taken or Being Planned

### According to the China Airlines

1. In response to: ...*Perform structural repairs according to the SRM, without deviation, and perform damage assessment in accordance with the approved regulations, procedures, and best practices.* (1.6, 2.2)

#### CAL Response:

CAL accomplished Boeing Service Bulletin (SB) B747-53A2489 (747 Fuselage - Skin - Lower Body Skin Inspection from STA 1961 to STA 2360) on March 6th, 2003 in accordance with an advance telex from Boeing.

CAA concurred with the CAL publication of QP 12ME009 dated August 7th 2003 to re-examine all previous patch repairs on the aircraft pressure boundary for the whole fleet, in response to CAA AD 2003-03-020A dated April 30th 2003.

QP 12ME009 specifies EO (Engineering Order) documentation for pressure boundary repair. The current repair EO must include:

- Warning wording: “Hidden structural damage can cause aircraft structure failure”;
- Categorization of the repair as “major” (QR 8.1.3 issue 8 dated August 1st 2004);
- Complete defect type and location description;
- Step by step instructions and signature requirements;
- A detailed drawing showing the extent and nature of damage, its location on the aircraft, doubler dimensions, material specification (including fasteners), applicable SRM section, and any special instructions;
- RII (Required Item Inspection) specified for the repair.

For structural repairs that are classified as RII, inspectors must follow “Duplicate Inspections on Aircraft and Aircraft Components, QR 8.1.5 Issue No. 6”, dated December 1st 2003, and “QP 08MI043 Issue No. 5”, dated August 31st 2004; inspectors must review work sheets in advance, and conduct inspections both during the repair process and after completion to ensure a damage free

condition and compliance with maintenance processes specified in the SRM procedures.

For any structural damage beyond existing approved data, CAL must seek assistance and consultation from the manufacturer(s) for appropriate repair procedures.

2. In response to: *...Review the record keeping system to ensure that all maintenance activities have been properly recorded. (1.6, 2.4.2)*

CAL Response:

CAL has revised QP12MI002 (Rev.2 dated July 30th 2004) in accordance with AC 43-001A (dated May 19th, 2004) issued by the CAA for Maintenance Record Keeping; notably, structural repair records are to be retained in accordance with CAA regulations and an additional copy of the major repair record will be specifically archived to establish a historical structural record for each aircraft on all fleets.

3. In response to: *...Assess and implement safety related airworthiness requirements, such as the RAP (Repair Assessment Program), at the earliest practicable time. (1.6, 2.4)*

CAL Response:

Currently, CAL has scheduled early implementation of CPCP tasks on all affected 747- 400 airplanes.

4. In response to: *...Review the self-audit inspection procedures to ensure that all the mandatory requirements for continuing airworthiness, such as CPCP (Corrosion Prevention and Control Program), are completed in accordance with the approved maintenance documents. (1.6, 2.4)*

CAL Response:

- a. CAL has changed the philosophy of control for planned maintenance tasks that do not correspond with the intervals of letter checks. The relevant data has been reviewed and transferred to a computer system so that such tasks can be controlled by an automatic system in accordance with the aircraft maintenance program. Thus, a basic (first



- level) self-audit system has been established with the aid of an automatic computer system. Implementation of this control methodology commenced before Apr. 30th, 2004.
- b. CAL EMD established a dedicated department, Engineering Planning Department (EPD), on May 10th 2004, to integrate such functions as planning, control, issuance of work orders, monitoring, etc. to ensure the overlap integrity of various tasks.
  - c. In accordance with CAA requirements, a check form (QP08MI052F1R0) originated from CAA, – form FSD-AWS-D-001 – was developed on June 15th, 2004 to ensure that all the mandatory requirements for continuing airworthiness are completed in accordance with the approved maintenance documents. Columns for the conformity of maintenance task planning and execution will be signed by an authorized person following review.
  - d. The Quality Management Office will conduct a yearly audit of EPD to monitor its operational effectiveness.
5. In Response to: *...Enhance maintenance crew's awareness with regard to the irregular shape of the aircraft structure, as well as any potential signs that may indicate hidden structural damage. (1.6, 2.2)*

CAL Response:

- a. As there is no existing visual inspection methodology that uses the liquid trace phenomenon to detect the structural anomalies, the case study of the CI-611 accident will be put into the training program by the CAL Technical Training Office, to instruct maintenance crew on how to detect hidden structural damage which results in irregular shape of the aircraft surface or visible liquid traces or stains. The OJT (On-the-Job Training) was conducted prior to August 1<sup>st</sup>, 2004. It includes discussion with maintenance crews of the indication(s) of possible hidden damage as shown in the photographs of the CI-611 doubler area. The formal training material was set up on July 30<sup>th</sup> 2004 by the CAL Technical Training Office.
- b. The Aircraft Inspection Section issued an "Inspection Circular" using the CI-611 accident as a case study to instruct inspectors on how to recognize early indications of hidden structural damage on July 27<sup>th</sup> 2004; Advanced OJT has been, and will continue to be, conducted

periodically by the Aircraft Inspection Section on a randomly scheduled, as-necessary basis, on maintenance inspection subjects that are necessary for inspectors to know. The Advanced OJT may be conducted by issuance of Inspection Circulars or provision of in-situ inspection guidance by the Foreman or Duty Manager.

6. In response to: ...*Re-assess the relationship with the manufacturer's field service representative to actively seek assistance and consultation from manufacturers' field service representatives, especially in maintenance and repair operations (1.6, 2.3)*

CAL Response:

CAL currently enjoys the benefit of a strong and communicative relationship with the manufacturer field service representatives from both Boeing and Airbus; both have proven cooperative and responsive to requests for technical support by the airline.

**According to the Civil Aeronautics Administration, ROC**

1. On Enhancing Flight Safety Management of Structure Maintenance of Aging Aircraft:
  - a. CAA cooperated with Boeing to host a "Technical Seminar on Maintenance of Aging Aircraft" at CAA's international conference hall on October 23-25, 2002. The seminar was conducted through lectures on specific topics and interactive discussions to provide the participants with necessary understanding, effective and feasible methods for developing maintenance program for aging aircraft and for managing their maintenance.
  - b. CAA and Flight Safety Foundation-Taiwan (FSF-T) co-hosted a seminar by inviting structure experts from Boeing and FAA to come to Taiwan to lecture on the developing status of RAP, SSID, CPCP and FAA's current policy on September 16-18, 2003.
  - c. Participants in the above meetings included delegations from the Aviation Safety Council of the Executive Yuan, local airlines and repair stations in Taiwan, and all airworthiness inspectors from CAA. The elaborations from the experts and interactive discussions have not only

contributed to the noticeable results in CAA's development of its policy for managing the aging aircraft, but also enhanced the management of structure maintenance of aging aircraft and the implementation capability of local aviation industry.

- d. CAA and four airlines in Taiwan jointly dispatched delegates to attend a meeting on structure maintenance of aging aircraft held by Boeing on May 17-21, 2004.
  - e. CAA held a seminar and training on aging aircraft structure and fuselage skin scribes on aircraft skin on December 22, 2004 to share relevant information and experiences with local air carriers.
  - f. Notwithstanding the fact that it has already met the requirements of ICAO Annex 6 and 8, CAA has developed ROC's management policy in rulemaking for aging aircraft by referring to FAA's six elements for managing aging aircraft. Moreover, CAA will continue to dispatch personnel to attend meetings held by the aircraft manufacturers with regard to aging aircraft to ensure the management of structure maintenance of aging aircraft is in line with the international standard.
2. On Revision of Related Regulations, Publication of Airworthiness Directive (AD), Administrative Order and Aviation Safety Bulletin:
- a. Prior to FAA's publication of Repair Assessment Program (RAP) AD and referring to the special maintenance requirements specified in FAR 121.370, CAA has treated it as a mandatory maintenance program amended in "Aircraft Flight Operation Regulation (AOR)" Article 131-2 in Section 2, Article 242-2 in Section 3 and Article 289 in Section 4. (CAA has issued AD 2002-009-002 to include RAP as a mandatory item.)
  - b. By referring to FAR 121.370a, CAA has amended in AOR Article 131-3 to mandate the inspection and procedure of "Structure Damage Tolerance Base" as a requirement in the maintenance program.
  - c. AD 2003-03-020 was issued on April 2, 2003 requesting operators to complete, within a specified timeframe, the assessment of the structure repairs on the airframe's pressure boundary skins by comparing the physical status and the repair records to identify whether the concerned repairs meet the specified standards. For any repair that can not be

confirmed, does not meet the requirement or has incomplete record, the operator has to redo the repair.

- d. CAA issued “Advisory Circular AC 120-017” for management of maintenance program on October 15, 2002 to provide the operators with guidance for developing maintenance program required by the regulations.
- e. In view of the abolition of related procedures after the publication of ROC’s administrative regulation, CAA issued AC 43-001 on August 1, 2003 to provide operators with guidance of continuous airworthiness release and maintenance records after performing various maintenance, repair, alternation and fabrication on aircraft, engines, propellers and their system equipment, components, etc. so as to meet the requirements stipulated in “Regulation for Aircraft Airworthiness Certification” and AOR.
- f. AC 43-002 was issued on September 1, 2003 to provide operators with guidance on the differentiation of major/minor repair when performing structure repair on airframe of aircraft and to describe the related requirements of maintenance release and record keeping for major/minor repair.
- g. CAA added the section of “Operator Maintenance Record-keeping Inspection” to Airworthiness Inspector’s Handbook on December 1, 2002 to provide guidance to the inspectors for conducting inspections.
- h. To ensure that operator’s maintenance of various fleets meets the aircraft maintenance program approved by CAA, CAA issued an administrative order on January 27, 2003 requesting local air operators to conduct self-audit by comparing their maintenance records with related aircraft maintenance program. The airworthiness inspectors from CAA also conducted an in-depth inspection in conjunction with all operators in May and all discrepancies found during which period had been corrected by the end of May 2004.
- i. To ensure that the requirements of continuous airworthiness and maintenance program are met, CAA has prepared Form FSD-AWS-D-001 (checklist of scheduled inspection items of aircraft and maintenance records) and Form FSD-AWS-D-002 (airworthiness statement) to remind the operators to strictly follow CAA requirements.

- j. To ensure the compliance of operator's maintenance records system with relevant regulations, in an efficient and complete manner, CAA issued a letter, No.09300024100, on January 27, 2004 requesting each operator to review its own maintenance records system and records keeping to determine whether it meets the above-mentioned requirements. CAA inspectors also conducted oversight inspections accordingly.
- k. CAA issued a letter, No.09200344410, on November 19, 2003 and a second letter, No.09300194500, on July 2, 2004 respectively to provide local air carriers with the following flight safety information from Boeing. The said information alerts the air carriers that the improper removal of sealant from the aircraft may leave scribe marks on the aircraft skin, which in turn may result in cracks on the skin; and that all carriers must use the tools specified by the aircraft manufacturer to remove the sealant. CAA issued another letter, No.09400016260, on January 14, 2005 requesting all operators to submit their training program on the correct use of sealant removal tools and to keep such training records for inspection.

### **According to National Transportation Safety Board**

#### **NTSB Recommendation to the FAA (April 8, 2003)**

- Establish appropriate criteria (taking into account the size of the repair and other relevant considerations) to identify those pressure vessel repairs to transport-category airplanes that could be hiding damage that, if not addressed, may lead to multiple-site fatigue damage and fatigue crack and could result in structural failure of the airplane. (A-03-07)
- Issue an airworthiness directive requiring all operators of transport-category airplanes with pressure vessel repairs identified as a result of applying the criteria discussed in Safety Recommendation A-03-07 (other than those covered by Service Bulletin 747-53A2489) to (1) immediately remove the repair doubler to determine whether hidden damage that could lead to multiple-site fatigue damage (MSD) or fatigue crack is present and, if so, repair the damage in accordance with the applicable structural repair manual (SRM) or (2) perform repetitive visual and nondestructive inspections for MSD and fatigue crack at appropriately conservative intervals until the doubler is removed and, if any crack is detected,

immediately remove the doubler and repair the damage in accordance with the applicable SRM. The results of these inspections should be provided to the FAA. The only repairs that should be eligible for exemption from these requirements are those that are supported by credible and detailed engineering documentation substantiating that the repair was performed in accordance with the applicable SRM and only after a visual inspection to confirm that the repair conforms to that documentation. (A-03-08)

- Inform maintenance personnel about the circumstances of this accident and emphasize that improper repairs to the pressure vessel may be hiding damage that allows the development of multiple-site fatigue damage and fatigue fracturing that could lead to structural failure. (A-03-09)
- Require the manufacturers of pressurized transport-category airplanes to include in their structural repair manuals, training programs, and other maintenance guidance, warnings about the possibility of structural failure resulting from hidden damage. (A-03-10)

### **FAA Response to the Recommendations (July 3, 2003)**

#### To A-03-07

The Federal Aviation Administration (FAA) agrees that appropriate criteria need to be established to identify those pressure vessel repairs to transport-category airplanes that could be hiding damage. The FAA agrees that if this issue is not addressed, it may lead to multiple-site fatigue damage and fatigue crack and could result in structural failure of the airplane. The FAA is working with airplane manufacturers to establish appropriate criteria. This effort involves independent discussions with various manufacturers to determine what criteria are appropriate for their airplanes and consolidation of the information into one general set of criteria. It is estimated that this effort could take approximately 8 months to complete.

#### To A-03-08

In response to Safety Recommendation A-03-07, the FAA is working with airplane manufacturers to establish appropriate criteria to identify those pressure vessel repairs to transport-category airplanes that could be hiding damage. Once the criteria are established and the FAA has identified airplane models that are determined to be at risk of failure due to hidden multiple-site damage as a result of improper repairs to the pressure vessel, the FAA will initiate appropriate

airworthiness directive action.

The FAA issued AD 2003-03-19 later on.

To A-03-09

The FAA will issue a flight standards information bulletin to discuss the circumstances of this accident and to address potentially catastrophic consequences of improper pressure vessel repairs. The bulletin will ask maintenance inspectors to emphasize to their respective air carriers during required inspections that improper repairs to the pressure vessel may be hiding damage that allows the development of multiple-site fatigue damage and fatigue fracturing that could lead to structural failure. The FAA plans to issue the bulletin by October 2003.

To A-03-10

The FAA is working with Boeing to determine what warnings might be appropriated to be included in the Boeing structural repair manuals (SRM). The FAA is also working with other transport airplane manufacturers to review their repair manuals to determine if additional warnings or cautions need to be included in the SRMs. In those cases where there is ambiguity in the repair instructions, the FAA will ask manufacturers to include clarifying material or warnings in their SRMs.

The FAA is also evaluating the need for general guidance relating to the repair of tail strike damage or of the damage that can result from hidden damage. I will provide the Board with any guidance material issued as a result of the evaluation.

**According to the Boeing Commercial Airplane Company**

Regarding improper repairs concealing damage:

Boeing issued SB B747-53A2489 (original release) on 26 Nov 2002 to recommend inspection of repairs in the tail strike area of B747 airplanes.

Boeing issued SB B747-53A2489 Rev 1 on 13 Mar 2003 to add an optional inspection method.

The FAA issued AD 2003-03-19 related to the above SB.

In developing the criteria for the SB, Boeing evaluated the potential for similar damage on other models and due to other causes that could lead to a catastrophic loss of structural integrity. That evaluation included a review of several hundred reports of scratched skins and lead us to conclude that only tail strikes are likely to cause the type of damage that could be hidden by a repair and lead to catastrophic loss of structural integrity. Boeing then evaluated each model for susceptibility to tail strike damage of this sort and concluded that only the B747 required a service bulletin for directed inspections.

Since then Boeing has also been working on a different issue known as "skin scribing" in which certain maintenance activities result in scribe lines on fuselage skins, which act like scratches and can lead to fatigue crack. However, this issue does not involve improper repairs concealing scratches or other damage that was the topic of the NTSB Safety Recommendation. There have been a number of activities related to skin scribing on various models.

Boeing has also been working with the FAA on their response to the NTSB Safety Recommendation related to improper repairs concealing damage. Boeing has suggested to the FAA that there are many similarities between this issue and the skin scribing issue and they may wish to address both issues consistently or even concurrently.



# **Attachment 1 - Comments on ASC's Final Draft Report from NTSB**



**NATIONAL TRANSPORTATION SAFETY BOARD**

Washington, D.C. 20594

Office of Aviation Safety

**December 17, 2004**

Attached are the final NTSB staff and advisor comments on the draft final report on the accident involving China Airlines flight 611, a Boeing 747-200, B18255, which crashed into the sea near Makung, Taiwan, on May 25, 2002.

The attached comments were compiled from the draft final report dated December 3, 2004. The December 3 draft report incorporates the substance of the comments provided by the NTSB staff and advisors on March 8 and August 6, 2004.

I would like to congratulate you and the Aviation Safety Council for conducting a very thorough investigation that resulted in a comprehensive and excellent report that identifies many significant recommendations that will increase aviation safety around the world.

Thank you for providing us the opportunity to review the Aviation Safety Council's draft report.

Best regards,

US Accredited Representative

Enclosure: China Air 611 NTSB Staff and Advisor Comments (Final)

With respect to the following sections of the draft report, the NTSB staff suggest the following changes:

#### 4.1.2 Safety Recommendations

##### To Aviation Safety Council, Ministry of National Defense, and Ministry of Justice

NTSB staff fully support these two recommendations. The NTSB has a Memorandum of Agreement with the US military so that all available radar data can be utilized in our safety investigations in the United States. In addition, NTSB staff have the authority to order an autopsy, when necessary, in order to obtain this important accident information.

NTSB staff agree with the following comments on the draft report provided by the Boeing Company.

Below are Boeing's comments on the CI611 Final Report Draft dated 3 December 2004. In quoted sections of the report, recommended insertions are underlined and deletions are shown with ~~strikeout~~.

#### **Volume I**

##### **Executive Summary**

###### Page i paragraph 1

The body of water where the crash occurred is referred to as the "Taiwan Strait", rather than "Taiwan Straits", on most maps, including those published by the Government Information Office of the Republic of China (ref: <http://www.gio.gov.tw/taiwan-website/2-visitor/map/index.htm>). The ASC may wish to revise this geographical name throughout the report.

For readability, we recommend that the last sentence be revised as follows:

One hundred and seventy-five of the 225 occupants on board the CI611 flight, which included 206 passengers and 19 crewmembers, sustained fatal injuries; the remainders-~~were~~ are missing and presumed killed.

##### **Findings Related to Probable Cause**

###### Page iv Finding 2

In this finding and in other locations in the report, the accident airplane is referred to by the registration number it carried at the time of the crash, B-18255. At the time of the tail-strike event, the airplane carried a different registration number. Therefore, we recommend that this finding be revised as follows:

On February 7 1980, B-18255 (then registered as B-1866) suffered....

This comment also applies to sections 2.3.1 and 2.3.1.1, page 156, and section 3.1, Finding 2, page 221.

###### Page iv Finding 4.

This finding summarizes the results in Section 2.2.6.1 of the report. To more accurately reflect the laboratory findings, and the text of section 2.2.6.1, we recommend that the finding be revised as follows:

Evidence of fatigue damage was found in the lower aft fuselage centered about STA 2100, between stringers S-48L and S-49L, under the repair doubler near its edge and outside the outer row of securing rivets. A cumulative length of 25.4 inches of fatigue cracks, including a 15.1-inch continuous through thickness crack and some small fatigue cracks (MSD) were confirmed. ~~Most of them were initiated from~~ The 15.1 inch crack and most of the MSD cracks initiated from the scratching damage associated with the 1980 tail strike incident.

This comment also applies to section 3.1, Finding 4, page 221.

Page iv Finding 5.

The residual strength analysis includes inherent conservatism. As a result, the calculated capability is somewhat less than the demonstrated capability. Therefore, we recommend that the last sentence of this finding be revised to read:

The skin assembly was beyond its calculated capability limit with the extent of identified damage during the application of normal operational loads.

This comment also applies to section 3.1, Finding 5, page 221.

**Other Findings**

Page vi Finding 4

This finding lists a number of scenarios which were considered and then ruled out by the ASC. However, "cargo door opening" is not included in this list, although it too was ruled out (ref section 2.1.6). Therefore, we recommend "cargo door opening" be added to this finding:

The ~~possibility~~ possibilities of a midair collision, engine failure or separation, cabin over pressurization, cargo door opening, adverse weather or natural phenomena, explosive device, fuel tank explosion, hazardous cargo or dangerous goods, ~~was~~ were ruled out as potentials of this in-flight breakup accident.

This comment also applies to section 3.3, Finding 4, page 225.

**Recommendations to Boeing**

Page xiv Recommendation 2

We would like to provide the following response to be included in the final report.

Boeing's NDI staff researches and develops for operator use new non-destructive inspection methods and tools that incorporate technological advances and accommodate evolving inspection needs. For example, new ultrasonic methods and tool were developed to assist operators with the inspection of repairs associated with tailstrikes in accordance with Service Bulletin 747-53A2489. These Boeing NDI research and development efforts will continue.

**Section 1.6.8**

Page 36 Figure 1.6-12

The red line in the figure that indicates the location of the crack on B-18255 is located too far away from S-49L. It is shown aligned with the second rivet in the shear tie between S-49L and S-48L. The actual crack location was closer to first rivet and is more accurately depicted in Figure 1.6-13.

**Section 2.2.5**

Page 145 Paragraph 2

We recommend the following revisions to clarify the location of the various stain marks visible in the photographs taken in November 2001.

The photograph is taken from underneath the airplane looking up towards the fuselage. This area of the aircraft belly slopes upward towards the rear of the airplane. When the aircraft is parked, the forward end of the doubler is closer to the ground than the aft end. There were several traces ~~been~~ observed on the doubler and the skin around STA 2100. ~~The traces~~ Traces 1, 2, and 3 are ~~in~~ brown ~~in color~~ and straight toward the aft of the aircraft, suggesting that the traces were induced by the relative wind during flight. Trace 4 shows several curved lines of transparent condensate liquid that flowed from STA 2090 toward the ~~fore~~ forward (lower) end of the ~~aircraft~~ doubler, consistent with flow due to gravity when the aircraft is parked. ~~(lower water level), suggesting that they were the result of gravity when the aircraft was on the ground.~~ The traces seen in the November 2001 photographs were not evident on the wreckage when it was recovered.

**Section 2.2.6.2**

Page 148 Paragraph 3

We recommend that this paragraph be revised as follows to clarify the findings of the laboratory work:

~~The fretting marks with significant damage were located~~ Fretting marks were more pronounced near the main fatigue crack area and ~~minor~~ less pronounced at ~~in~~ both ends of the crack. This pattern is consistent is correspondent with the theory that the fretting marks were caused by the repetitive opening of the crack. ~~The rivets along the crack caused the skin and the repair doubler around the rivets/holes much tighter, therefore resulted in most of the fretting damages were located on the rivet/hole locations.~~ Most of the fretting damage is located adjacent to fastener locations, where rivets held the skin and doubler in direct contact.

**Section 2.2.8**

Page 155 Paragraph 8

This paragraph states that “significant pitching forces ... likely led to the separation of the engines at altitude”. We are not aware of conclusive evidence that suggests engine separation was due only to pitching forces rather than some combination of forces in various axes. Indeed, some of the pylons show signs of side-acting loads. Therefore, we recommend that the first sentence of this paragraph be modified as follows:

During the breakup process, the abrupt change in ~~pitching moments~~ aerodynamic characteristics would likely have resulted in significant ~~pitching-inertial~~ forces that ~~likely~~ led to the separation of the engines at altitude.

### **Section 2.3.1**

#### **Page 156**

This section describes the tail strike occurrence, ERE (747)AS062 (Appendix 3) and the subsequent repair. The ASC may wish to consider adding information about an inconsistency that exists on the sketch that accompanies the ERE. For the Section 46 damage, the ERE depicts a temporary repair doubler 23" wide covering the area from S-49L to S-49R. In actuality, the distance from S-49L to S-49R is greater than 23". The doubler recovered on item 640 measured 23" wide and covered only from S-49L to S-51R. The ASC may also wish to consider adding a statement that the 25 May 1980 Major Repair and Overhaul Record (Appendix 7) does not specify whether it is referring to the Section 46 repair, Section 48 repair, or both.

#### **Section 2.3.1.1**

##### **Page 156 Paragraph 1**

This paragraph discusses the SRM requirements for damage within and beyond the allowable limits. The SRM allows blend outs when the damage is within allowable limits but does not prohibit an operator from installing a doubler or replacing a skin in such situations. Currently, the second sentence in the draft report could be interpreted to imply that the SRM does not allow replacement or a doubler repair if the damage is within allowable limits. Therefore we recommend that this sentence be revised as follows:

Specifically, the Boeing SRM ~~required that~~ allows scratches in the damaged skin within allowable limits to be blended out, ~~or if~~. If, however, the damage was too severe and beyond allowable limits, the damaged skin had to be cut off and a doubler was to be installed, or the old skin was to be replaced with piece of new skin.

##### **Page 157 Paragraph 2**

This paragraph mentions three repair doublers on the lower portion of the fuselage, one in Section 46 and two in Section 48. A fourth repair doubler is visible in the photographs taken in November 2001. It is located in Section 46 immediately aft of the item 640 doubler and appears to occupy the area enclosed by the dimension lines on the sketch accompanying ERE(747)AS062. The section of fuselage skin containing the fourth doubler was not recovered. The ASC may wish to mention this doubler by adding a new sentence between the first and second sentence:

A fourth repair doubler located just aft of the item 640 doubler is visible in the photographs taken November 2001. The section of fuselage skin containing this fourth doubler was not recovered.

The sixth sentence states no records could be found concerning the Section 48 doublers. However, ERE(747)AS062 (Appendix 3) shows the temporary doubler in section 48. In addition, as noted above, the 25 May 1980 Major Repair and Overhaul Record (Appendix 7) does not specify whether it is referring to the Section 46 repair, Section 48 repair, or both. Therefore, the ASC may wish to consider revising the sixth sentence to read:

However, no additional records can be found regarding the two repair doublers in Section 48...

**Section 2.3.1.2**

**Page 157 Paragraph 1**

The first sentence should be modified as the noted section of the SRM is applicable to fuselage skin only:

The 1976 version of Boeing SRM 53-30-01 Figure 1 provided allowable damage to the aircraft fuselage skin.

The third sentence should be revised to indicate that the SRM permits both replacement or repair of damaged structure:

The remaining skin must be no less than 85% of its original thickness when the length of the damage is longer than 11 inches; otherwise the damaged area must be replaced or repaired per SRM 53-30-03 to restore the structure strength.

**Section 2.4.1**

**Page 163 Paragraph 3**

This paragraph discusses the capability of high frequency eddy current (HFEC) inspection to detect the presence of a crack in the fuselage skin under the item 640 doubler. While HFEC would not have been able to detect the crack through the doubler, HFEC would be capable of detecting the crack if the inspection were conducted from inside the airplane. Therefore, we recommend that the last sentence be revised to read:

Therefore, the crack would still not be detected if ~~the~~ external high frequency eddy current had been used for structure inspection.

**Section 2.4.1.1.1**

**Page 164 Paragraph 2**

The document name was omitted from the first sentence:

The Boeing CPCP document categorizes structural inspections into three different levels depending on the intensity needed for the inspection: general visual, surveillance, and detailed visual.

**Section 2.5**

**Page 177 Paragraph 2**

We recommend that second paragraph of this section be revised as follows to clarify the concept of residual strength

Replace this paragraph:

“Residual strength” is the static strength capability of a structural component for a given set of damage, or cracks. With existence of cracks in the aircraft structural component, the residual strength will decrease with the growing of the crack length. The residual strength should always excess the limit loads of the aircraft to ensure the structural safety when aircraft is in services. Once the residual strength falls below the operating loads , the structure will no longer sustain the loading and the structural failure will occur.

With this paragraph...

“Residual strength” is the strength capability of a structural component for a given set of damage, or cracks. Residual strength analysis is used to determine the critical damage length. Critical damage is the maximum damage, including multiple site damage (MSD), that can exist before the capability of the structure falls below regulatory load conditions. It should be noted that regulatory load conditions are typically significantly higher than the maximum operating load expected to occur during a typical flight.

## **Volume II**

### **Appendix 16 BMT Lab Report**

The BMT Report included in Volume II is the original issue of report MS22570 dated December 2002, which contains an error on Figure 20. It should read, “Figure 20, SEM photograph showing the compressive deformation of the cladding just forward of Hole +15.” The error was corrected in Revision A of report MS22570, which was provided to the ASC in March 2003. Revision A should be included in Volume II instead of the original release. When the change is made, we ask that the ASC omit the names of the Boeing employees who prepared the report, as has been done in the current version of Volume II.



# **Attachment 2 - Comments on ASC's Final Draft Report from CAL**

February 3<sup>rd</sup> 2004

CHINA AIRLINES



台北市南京東路三段一三一號  
131, Nanking E. Rd., Sec. 3, Taipei, Taiwan, R.O.C.  
Tel: (02) 715-2233 / 506-2345

**To:**  
Chairman and Managing Director, ASC  
AVIATION SAFETY COUNCIL  
THE EXECUTIVE YUAN, R.O.C.  
16<sup>th</sup> Floor, 99 Fu-Hsing North Road  
Taipei, Taiwan, R.O.C

**Subject: Accident to China Airlines Boeing 747-200  
Over the Taiwan Strait on the 25<sup>th</sup> of May 2002**

**Reference: Aircraft Accident Report (Final Draft) dated January 14<sup>th</sup>, 2005**

In response to your report at reference, China Airlines has examined the subject report at length and is providing our comments as an attachment to this letter; we respectfully request that this letter, along with its attachments, be appended to the final published report of this accident, in accordance with established practice.

We appreciate ASC's continued openness regarding the concerns of China Airlines and the fair and objective manner in which the investigation and report have developed. It is unfortunate that a large portion of wreckage from section 46 was not recovered, as it would have been of help in arriving at a definitive conclusion with respect to the location on the fuselage of the initiating cause of the inflight breakup.

The Report made some determinations and recommendations concerning maintenance procedures at China Airlines, and we have taken these to heart as lessons learned from this accident. We have made numerous improvements in our maintenance structure, training and documentation as a result. Those resulting action items were listed in an earlier submission, and we are grateful that you have chosen to include them in the Final Report as an indication of our diligence and sincerity.

Throughout the investigation we have gone to great lengths to contribute to the investigative process to the extent possible. As a part of that contribution, we have undertaken to examine some of the factual data contained in the Appendices to the Report, particularly in the area of metallurgy. Although we essentially agree with the Report, we have arrived at some opinions which differ from interpretations of factual data contained in the Final Draft Report. Our observations have been collated and attached at Attachment A to this letter, representing China Airlines comments with respect to metallurgical aspects of the investigation in response to the latest revision of the Final Draft Report.

Additionally, as mentioned above, we have carefully addressed all safety recommendations offered in the Report, have verified that corrective action has been taken, and have provided documentary evidence substantiating those changes to ASC.

Finally, we would like to congratulate ASC on the production of a professional, thorough, and enlightened Final report. The Report will serve as a guide to investigators everywhere on how to proceed with a major and complex investigation, and to assemble an appropriate Final report.

Yours Sincerely,

Attachments

- A China Airlines Comments - Metallurgical Examinations
- B CD ROM containing electronic copy of China Airlines Comments

## **Attachment A**

### **China Airlines Comments - Metallurgical Examinations**

#### **Foreword**

Part One of this attachment was submitted to ASC in February 2004 by China Airlines. It has been reviewed in its entirety by China Airlines, and has been adopted as China Airlines considered opinion with respect to metallurgical interpretations resulting from several examinations of accident wreckage.

Subsequent to that time further examinations of the item 640 doubler edge (faying surface) were undertaken at CSIST (in September 2004). Observations were made concerning metallurgical interpretation of the information gleaned at that time. The comments have been reviewed in their entirety by China Airlines, and constitute the considered opinion of China Airlines; they are appended as Part Two of this attachment.

Parts One and Two of this attachment, although written predominantly in the first person, as seen through the eyes of our metallurgist expert, nevertheless have been adopted by, and as such represent the combined opinion of, the China Airlines designated investigation team.

## Part One

### Report Regarding Metallurgical Examination CI-611

#### 1 REFERENCES

- 1) Chung Shan Institute of Science and Technology (CSIST)- Report 910383 draft copy of which is undated but believed to have been released October 14, 2002; herein referred to as CSIST report;
- 2) Boeing Materials Technology Engineering Report MS 22570 dated December 18, 2002; herein referred to as the Boeing report.

#### 2 BACKGROUND

- 2.1. The following report presents what I consider to be factual information that was developed during the examination of the components as well as my interpretation and analysis of these facts.
- 2.2. I was not present throughout all times during the examination of components from the accident airplane. However, I was present during the initial and critical examinations of specific components and follow-up discussions at CSIST that culminated in the CSIST report and for the time frame of November 5 to 15, 2002 pertaining to the Boeing examination and report reference 2). In addition, I examined a considerable portion of the accident hardware that was recovered.
- 2.3. For the record, I did not have the opportunity to review the Boeing report until about April 19, 2003, when this document was first supplied to me. The Boeing report incorrectly indicated the presence of China Airlines representatives at the Boeing examination through the time frame of November 22, 2002. To my knowledge no representatives of China Airlines, including myself, were present at Boeing from November 16 through 22, 2002.
- 2.4. I left the Boeing examination at the end of November 15, 2002 with the full understanding that there were no further examinations that were going to be made and that the added time to November 22 would be needed only to collate what information was available and already documented. However, before leaving Boeing I was apprised of and agreed to the fact that there was one area of fracture outside of the slow growth fatigue regions in the form of a step-wise roughened fracture morphology that may have been evidence of cyclic progression. This step-wise region was positioned near rivet holes 1 to +1 relatively close to the main through-the-thickness fatigue regions. My examination disclosed no other regions containing evidence of cyclic progression in areas determined to be indicative of overstress in the CSIST report. It was after November 16, 2002 that the Boeing Company introduced the theory of quasi-stable fracture outside of the slow growth fatigue cracking regions and expanded their interpretation of the length of fatigue cracking.

### 3 CSIST AND BOEING REPORTS REGARDING SKIN FATIGUE S-49L

#### Regarding Boundary Extents of Slow Growth Fatigue Cracking:

- 3.1. Both the CSIST and Boeing reports as well as my examination of the hardware indicated that the furthest forward and furthest aft positions that contained small intermittent areas of slow growth fatigue cracking were at rivet hole location +14 (on aft side of hole, at approximate STA 2062.7) and at rivet hole 51 (on the aft side of hole at approximate STA 2133.4). There appears to be no disagreement regarding this fact. Also, in all instances the slow growth fatigue cracking propagated primarily in the upward direction (direction through the skin thickness). The physical distance between the most forward crack and most aft crack is approximately 7½ inches. This does not mean that a continuous crack existed between these areas. Instead it only describes the most forward and most aft positions where small separated cracks were found. Figure 11 of the CSIST report probably best shows how discontinuous and small these cracks are in the area.

#### Regarding Additional Slow Growth Fatigue Areas

- 3.2. The CSIST report did not identify some small slow growth fatigue regions that were reported in the Boeing report. The Boeing report indicated that there were 3 additional cracks at rivet hole positions of +11 aft, 33 aft and 34 forward<sup>1</sup> that were not reported on in the CSIST report. My examination indicated that there was an indication of an additional small fatigue crack in the position corresponding to the aft side of rivet hole +11. However, the additional cracks identified in the Boeing report at rivet holes 34 forward and at rivet hole 33 aft were much less clear, if indeed they did exist.
- 3.3. While at Boeing and in my presence an attempt was made to prove by SEM examination that there was a fatigue crack on the forward side of hole +11. Results of that examination showed that the +11 fwd crack indication had an overall and high magnification fractographic appearance similar to the other fatigue areas that were examined using the SEM. Even though visible striations could not be found, the features at the crack indication at hole +11 aft appeared identical to other fatigue areas similarly examined. Again, it was not clear whether there were small fatigue cracks at 33 aft and 34 forward and there were no SEM examinations made of these suspected crack indications to verify their presence.
- 3.4. In addition, the CSIST report identified indications of slow growth fatigue cracking at the forward position of rivet hole +1 (10 to 20% through the thickness). In the Boeing report there is no mention of this cracking (missing from Table IV, page 31, reference 2).

---

<sup>1</sup> Identified in Boeing text pg 3 as aft but in reality was forward. In Table VI, page 31 correctly identified as forward.

Regarding Stable Crack Growth in Overstress Regions

- 3.5. The CSIST report makes no mention of any observed cracking outside of the slow growth fatigue regions and the interpretation outside the fatigue regions was that they were produced by a single load overstress stemming from the slow growth fatigue regions. However, the Boeing report indicated that there were numerous areas in the overstress regions that were indicative of stable crack growth, which Boeing alone identified as "quasi-stable" fracture. These Boeing named "quasi-stable" fracture zones were in the form of somewhat step-wise roughened fracture morphologies that could be seen on a macroscopic scale but which had both macroscopic and microscopic overstress features containing no evidence of fatigue striations.
- 3.6. My detailed visual examination of all the fractures disclosed only one area suggestive of any incremental high-stress fracture progression, as indicated below.
- 3.7. The only pronounced step-wise fracture region is that documented in Figures 15 of the Boeing report located on a plane offset from rivet holes 1 to that of rivet hole +1. This area is adjacent to the frame position at body station 2080 and is well within the extents of undisputed slow growth fatigue positions. These rivet hole positions were downstream<sup>2</sup> of (in this case forward of) the 100% through-the-thickness slow growth fatigue cracks that were centered near rivet holes 4 and 5. In addition, this area is just downstream of where the shear tie fastens to the 2080 frame. Transference of load to the 2080 frame as the fracture progresses through the shear tie connection could lower the stress in the skin and perhaps account for the incremental fracture phenomenon in this region. The exact number of steps in this region is unclear but the Boeing Report indicated there were 14 steps in their photographic display of Figure 15.
- 3.8. Boeing reported an appearance of incremental crack growth indications (Boeing termed quasi-stable) between rivet holes +9 and +10 as shown in the top photograph of figure 16 in the Boeing report. This area is well downstream of (forward of) the nearest completely through-the-thickness fatigue cracking and is just before (in this case aft of) small slow growth fatigue regions near the forward extent of slow growth fatigue cracking. The markings in this area were extremely faint and much less obvious than that between 1 and +1. As a further note, the area contains no evidence of slow growth fatigue immediately upstream from this position and is in an area far removed from the nearer 2060 frame connection. At best there are only about 3 steps indicated on the fracture and these are unclear.
- 3.9. Other areas that the Boeing report indicated were representative of stable crack growth in overstress regions were those shown in the center photograph (between rivet holes 32 and 33) and lower photograph (between rivet holes 55 and 56) of figure 16 and in figure 17 (around rivet hole 7). These areas also contained extremely faint

---

<sup>2</sup> Downstream is in the direction away from the primary overstress from the main fatigue area.

marks with little or no step-wise deviation in the fracture plane. Again, there were only about 3 faint marks in each of these areas. The fracture area between rivet holes 55 and 56 is well downstream of (in this case aft of) the undisputed aft extent of slow fatigue crack region at hole 51. Whether these marks were made by the fracture process cannot be established without corroboration by the existence of identical marks on the mating fracture half (mating half not recovered). Even if by chance these marks were indications of momentary fracture stoppage this cannot be considered as evidence that these were produced before the accident flight.

- 3.10. Incremental crack growth outside of the position extents of localized and isolated regions of slow growth fatigue cracking is not only highly speculative but in my opinion nonexistent and unsupportable.
- 3.11. Boeing also surmises in their report that rubbing or deformation of the thin clad section of the fracture as far aft as rivet hole 62 is evidence of overstress crack stoppage and subsequent crack closure produced from contact with the mating fracture surface. I disagree with this analysis and as far as I know it has no basis to be considered as fact. The appearance of the cladding separation in this area was not indicative of a rubbing wipe and was remarkably different than that found near the primary fatigue regions (compare figure 19 to that of 21 in the Boeing report) Again, even if by chance these were indications of momentary fracture stoppage and crack closure, it can not be considered as evidence that these were produced before the accident flight.

Skin Fracture Extending Forward of STA 2060:

- 3.12. The Boeing report, with no photographs or other documentation evidence supplied, indicates that there was incremental crack growth as far forward as BS 2055, approximately 5 inches forward of the doubler edge in an area where the skin is not covered by the doubler. The CSIST report does not mention this area of the fracture. Whether this area of the fracture forward of the doubler contained irregular fracture and/or post fracture mechanical damage is unknown since it is not documented in any of the reports. However, even if it does contain suspicious fracture it cannot be said that it occurred prior to the accident flight. A more likely scenario is that this fracture forward of STA 2060 was produced during the accident flight or perhaps even after the initial breakup of the airplane.

Regarding Major and Minor Striation Development:

- 3.13. The CSIST report concludes that there are minor striations near the terminus regions of slow growth fatigue cracking that are probably associated with smaller alternating stress conditions promoting the fatigue cracking. These minor striations were within more pronounced major striations. Boeing, in their report suggests that minor striations in structural components are not unusual and gives the impression that these are expected for all structural components near the critical stages of crack growth (Boeing used the term "mature"). The Boeing report



does not reference why they believe these minor striations are not unusual.

- 3.14. I agree that the primary stress cycle promoting cracking is that of the pressurization cycle producing the major striations and that for purposes of determining the number of flight cycles the minor striations can be ignored. However, I do not agree that these minor striations are common occurrences that are to be expected in all fatigue fractures near the critical stages of cracking in structural materials. Boeing has offered no proof that constant or near constant load amplitude cycling stress produces these minor striations.
- 3.15. My interpretation of the minor striations is that they are signifying minor changes in the stress state as a result of small changes in pressurization load and/or as a result of applied fluctuating stress cycles during flight. Applied fluctuating load can occur during flight from the change in bending stress in the fuselage along the longitudinal axis when the down load on the horizontal tail varies during flight. In essence, the change in the tail load will vary the stress especially in the presence of a significant opening in the fuselage and/or detachment of frame structure to the skin. In general there appeared to be about 3 minor striations for every major striation near the latter stages of slow growth fatigue cracking. The so-called "quasi-stable" fracture regions outside of the slow growth fatigue regions in the most part appeared to have about 3 offsets, which is of similar magnitude to the minor striations being developed in the later stages of slow growth fatigue. It is therefore believed that tearing of the fuselage structure outside of the well-defined fatigue regions could very well be associated with applied stress from alternating tail loads or perhaps even changes in pressurization produced during the accident flight.
- 3.16. The Boeing report states that the "quasi-stable" fracture region at its extremities was formed before the last flight and even indicated some of the region forward of STA 2060 would have been visible forward of the doubler before the flight. I strongly disagree with that assessment. Instead, these areas (if indeed they were representative of fracture extensions) most likely occurred during the last flight from applied fluctuating tail loads and/or pressurization deviations.
- 3.17. Even though incremental fracture growth may have occurred in some form in the areas formally assessed as overstress in CSIST report, it has not been established with any degree of certainty that most of it occurred as a stable crack, let alone before the accident flight. When or how most of the fracture areas occurred outside of the well-established slow growth fatigue regions is not known nor can be speculated on with the evidence available at hand.

#### 4 PROBABLE EXTENT OF PREEXISTING THROUGH-CRACKS<sup>3</sup>

##### Prior to Last Flight

- 4.1. There is little question that the slow growth fatigue cracks occurred prior to the accident flight. Also there appears to be adequate detail presented in both the CSIST and Boeing reports to indicate the extents and lengths of these slow growth fatigue cracks along the bottom surface of the skin. However, the magnitude of this slow growth cracking that had penetrated through to the inner surface of the skin was not established. Nonetheless an approximation can be made as to the length and amount of cracking exposed to the inner surface from the available data.
- 4.2. Figure 11 in conjunction with figures 5 through 10 of the CSIST report were used to approximate the upper surface penetration of the slow growth fatigue cracks (cracks exposed to the inner surface of the airplane). From these figures it was estimated that the longest crack penetrating the inner surface was about 8 inches in length (between rivets 10 and 11 to just aft of rivet 19). The second longest crack penetration on the inner surface was about 3.5 inches (from rivet 22 to about mid position between 25 and 26). In addition there appeared to be approximately 1 inch or so lengths of cracks around rivets 4, 5 and 21. Although there were more cracks that appeared to penetrate the inner upper surface of the skin (such as 10 fwd and 27 fwd and aft) the lengths of those cracks along the inner surface were so small that they could be discounted (in addition would be covered by the rivet tails).
- 4.3. Other than the above no degree of certainty can be established regarding the through-crack length before the last flight.
- 4.4. However, the multiple step-wise fracturing just aft of hole +1 suggests that a through-crack could have existed to hole position +1 (BS 2078) on the forward end. It is also probable that on the aft end the through-crack was at least to the extent of slow growth fatigue cracking between rivets 25 and 26 (BS 2107.5). Whether the through-cracking was continuous between these extremities or of multiple varying lengths is unknown but if it were continuous from these extremities the crack would be approximately 29.5 inches long.

##### At Last Visual Inspection During Mid Period Visit (MPV) Occurring 12/17/98 to 1/11/99

- 4.5. A portion of the slow growth fatigue cracking had to have propagated subsequent to the last visual inspection required in this area. Striation data generated during the examination of the slow growth fatigue areas can be used to approximate this amount of propagation.
- 4.6. The airplane had accumulated 21,398 flight cycles at the time of the accident. During the MPV a visual inspection was performed on the inner surface of the skin and at that time the airplane had accumulated

---

<sup>3</sup> Through-crack would be a crack completely through the thickness of the skin.

18,241 flight cycles. Therefore, between the last visual inspections up until the time of the accident the airplane sustained 3,157 flight cycles.

- 4.7. Striation data was obtained in numerous areas where maximum lengths of cracks occurred in slow growth fatigue that represented 100% through the thickness cracking (specifically between rivet hole locations 12 and 25). Using the striation data from the Boeing report for these areas (pages 101 to 110 of the Boeing report) calculations can be made to estimate the depths of the fatigue cracks 3,157 cycles prior to the accident. At each line of striation counting the estimate of crack depths showed that they had not penetrated the upper surface of the skin. The deepest penetration upward from the lower surface was associated with the hole 15 area and its depth was estimated at no more than 1.33 millimeters (mm). The skin thickness in this area was about 1.76 mm. Thus the deepest crack was approximately 75% through the thickness of the skin during the time of the last visual inspection and could not be detected by visual inspection of the area.

## **5 RIVETING AT THE CRITICAL ROW OF RIVETS**

- 5.1. The critical rows of rivets are those nearest the outside edge of the doubler. Some of the critical row of rivets – specifically those centered near the primary fatigue cracking around STA. 2100 above stringer 49L – contained rivet tails (interior bucked button ends) that were heavily deformed. One such rivet (identified as 19 in the referenced reports) was even deformed off center with a small part of the rivet tail having a high side. This rivet was adjacent to a blind rivet attaching the repair doubler and skin to a shear tie, transmitting load to the STA 2100 frame. The area of the doubler and skin centered on STA 2100 was found after the accident to be in a permanent set as if locally deformed by pillowing (or bulging) outward away from the normal fuselage skin plane.
- 5.2. The formation of the rivet tails found above stringer 49L around STA 2100, and much less severe in nature in other areas, suggests that the riveting was done in part to reform (or deform into place) the skin and/or doubler sheet so as to produce a fastened joint in these areas. The bottom of the airplane around STA 2100 is reasonably flat for the most part between stringers 50L and 50R with an apparently more curvilinear change upward from these locations. The riveting in the STA 2100 along stringer 49L area appears to be more reflective of mechanically forming the doubler and skin than it would be from just normal riveting of one piece to another. To imply that the rivet is “overdriven” as a normal course of repair is misleading. Instead, this over flattening of rivet tails may have been what was needed to fasten the joint together in the forming of the doubler attachment.
- 5.3. The implication that the rivet tail does not meet the requirements of the SRM has little significance from a structural standpoint so long as the rivet does not fail. Even though these rivet tails were formed below that of a defined minimum height and had larger diameters than a defined maximum they nonetheless remained intact – still transferring load. If

the rivet tails had failed in shear so as to pop off the tail and loosen the joint then there would be significance in the fact that the rivet tail was overly deformed. Again, the rivets did not fail in this area nor was there any appreciable number that failed over the whole of the repair doubler.

## **6 SKIN SCRATCHES UNDER THE CENTRAL PORTION OF THE DOUBLER:**

- 6.1. The deepest and most pronounced scratching of the skin from the 1980 abrasion event was found to be associated with the support stringers and shear ties reinforcing the skin area. This extensively scratched area was situated for the most part well under the location of the doubler repair and away from the critical rows of rivets. Even though these centralized areas displayed relatively deep residual scratches there was no evidence of cracking associated with them. These centralized scratches posed no problem since almost the total skin thickness was still available to support the load and with the doubler repair attached to this damaged area the stress would be approximately halved in the skin. There appears to be no adverse consequences resulting from leaving the scratched skin area intact and covering it with a doubler (instead of cutting it out) provided that the scratched area is not at or outside of the critical rows of rivets.

## 7 CONCLUSIONS:

- 7.1. There are minor differences in the description of the slow growth fatigue regions between the CSIST and Boeing reports. Except for one small crack positioned on the aft side of rivet hole +11 the extents and positions are probably best and most accurately identified in the CSIST report.
- 7.2. Step-wise fracturing in the region near holes identified as 1 and +1 may indicate differing magnitudes of stress applications at or near an overstress condition that progressed the fracture. The number of stress applications in this region is unclear but could be about 14 or so in number. Using the above as evidence of completely through-the-thickness fracture the furthest forward extent of 100% through the thickness fracture would be at hole +1 (approximate BS 2078).
- 7.3. The faint step-wise fracture regions outside of those indicated in the vicinity of rivet holes 1 and +1 should not be considered as being evidence of preexisting cracking to those positions prior to the accident flight.
- 7.4. Boeing's interpretation of deformed cladding at rivet hole positions 57 to 58 is inconclusive in establishing preexisting cracking prior to the accident flight. A more likely scenario is that this deformation resulted during the accident flight or for some other reason.
- 7.5. Using the step-wise fracture to the rivet hole +1 position as evidence of preexisting through-cracking the overall length of through-cracking in the skin at the time of the accident flight was approximately 29.5 inches.
- 7.6. Unless it can be otherwise proven the minor striations could be signifying loading conditions as a result of longitudinal fuselage bending and/or pressurization deviations.
- 7.7. The slow growth fatigue cracks could not be detected by visual inspection from the outside of the airplane since they were covered by the repair doubler.
- 7.8. At the last visual inspection during the MPV the slow growth fatigue cracks did not penetrate the upper inner surface of the skin and therefore could not be detected by visual inspection from the inside of the airplane.
- 7.9. The over-flattening of the rivets on the upper rivet row along stringer 49L appear to be associated with in place doubler forming and did not jeopardized the joint integrity.
- 7.10. There appears to have been no adverse consequences resulting from leaving the scratched skin area intact and covering it with a doubler (instead of cutting it out) provided that the scratched area is not at or outside of the critical rows of rivets.

## Part Two

### **Comments Regarding the Hoop-wise Markings on the Doubler Faying Surface**

I examined the hoop-wise rub damage to the doubler in great detail while at Boeing in November 2002 and again at the CSIST in September 2004.

My observations of the hoop-wise rubs were as follows: The hoop-wise rubs 1) were not continuous from rivet to rivet (did not exhibit a fracture fretting line as would be expected from a continuous crack), 2) were of differing magnitudes and in some cases highly local and extremely small and, 3) in the most part appeared clearly fresh (no evidence of aluminum oxidation that would normally be expected on long term fretted surfaces).

I also examined the photographs of the SEM viewing and metallographic sections of the rub area associated with rivet hole 32 that were taken during the September 2004 examination at CSIST and have the following comments: The SEM examination did not show deposits other than that which would have been expected considering the environment that the area had experienced subsequent to the airplane breakup (water and seabed contamination, retrieval environment on deck of a ship and land exposure before and after laboratory examination). The metallographic sections showed no clear evidence that there were repeated movements due to fretting. For the record I respectfully take exception to the terminology used by CSIST that there were superimposed rubbing or rubbing deposits found during this examination.

## Conclusions:

- 1 The hoop-wise markings appeared to be related to crack opening with no evidence of crack closure. Because of this, the hoop-wise rubbing damage most likely was produced rapidly as a result of the overall fracturing in the area and not as a result of numerous cycles of pressurization stress.
- 2 If a continuous crack did exist in the presence of repeated hoop-wise movements of the flapping skin piece (not recovered) there should have been extensive areas of fretting along the whole of the crack fracture line, not just in a few areas associated with some of the rivets, especially some highly local small areas of rub. If varying hoop stress had caused the skin flap to produce these marks they should have been readily evident between the rivet holes as well. Since there was no evidence of continuous or near continuous hoop-wise mark associated with the crack line these hoop-wise marks could be construed as evidence that there was not a long continuous crack before the accident flight.
- 3 Localized rub damage resulting from a mere tightness between the fuselage skin and doubler (due to riveting) does not appear to be an adequate explanation for the localized rub. If tightness (clamping) from riveting was the cause for the localized areas, it is logical to expect that this rubbing would be all around the rivet holes and not in just sporadic localized areas at certain rivet locations. Areas adjacent to the rub "fretting" areas (at the same distance from the rivet) appeared to have the original surface finish of the doubler (completely untouched by mating surfaces) yet these same areas should have been subject to the same relative clamping force (tightness) from the riveting operation.



# **Attachment 3 - Comments on ASC's Final Draft Report from CAA, ROC**



中華民國交通部民用航空局  
**CIVIL AERONAUTICS ADMINISTRATION**  
MINISTRY OF TRANSPORTATION AND COMMUNICATIONS  
REPUBLIC OF CHINA

FAX: 886-2-2349-6277  
<http://www.caa.gov.tw>

台北市 105  
敦化北路 340 號  
340, TUN-HWA N. ROAD  
TAIPEI, TAIWAN, 105

December 16, 2004

The Civil Aeronautics Administration is pleased to provide its comments on the Final Draft revision 2 of your Report regarding China Airlines Boeing 747-200 in-flight breakup over the Taiwan Strait on 25 May 2002.

We have noticed that in this revision 2 you had taken consideration of our earlier presentations. Apparently, the changes that you already made have enhanced the clarity and accuracy of the report. However, there are some additional presentations that we hope will be of further assistance in your efforts to make the clearest and most accurate report possible. Moreover, the CAA provided document has been formatted in accordance with the request made by the ASC.

With the conscientious dedication to the consummation of the investigation report, my staff and I wish to invite your generous attention to the suggestions made as our responsive comments including the previous CAA comments dated August 5th and to their reservation in the Appendix of the Final Report.

As a matter of fact, the staff of ASC under your dynamic leadership have again demonstrated the function of your organization in a professional manner. In recognition of your great contribution to aviation safety, we take this opportunity to sincerely appreciate your unfailing assistance rendered to us.

Sincerely,

**CAA of Taiwan Representations to the ASC on the Final Draft of  
the Report on the Investigation of the China Air Lines Boeing  
747-200 Accident on May 25, 2002**

**General**

The CAA appreciates the opportunity to make representations related to the Draft Final Report on your investigation into the 25 May 2002 in-flight breakup accident involving a twenty-two year old Boeing 747-200 that was being operated by China Air Lines as Flight CI611. In general, the CAA found the Report reflects a thorough and professionally conducted investigation. As part of their work, the ASC investigators had to conduct an extremely difficult and lengthy deep-water, typhoon interrupted, wreckage recovery exercise. While doing that, in the glare of media attention, they were able to respect the urgent need to identify victims and return them and their belongings to the next of kin.

These representations made by the CAA are solely with the object of increasing the fairness, accuracy and clarity of your draft Investigation Report. We hope in this way to support your purpose of advancing aviation safety in The Republic of China and throughout the world. Our representations are not to be used for any purpose other than the advancement of aviation safety. The ASC authors of Final Draft Report took information from several sources to modify what was in the Preliminary Draft report. That has resulted in considerable new factual information and, as might be expected, it has led the CAA to comment on some of that information. It has also resulted in us offering some corrections to information that we provided earlier and elaborations where we did not make plain some of the points that we tried to make earlier.

In technically-advanced, well-managed and carefully operated systems with a high degree of integration and interdependence such as civil air transport, there are occasional safety failures in the form of accidents. When such failures do occur, they are unexpected, often serious and they attract intense public scrutiny. To maintain public confidence in the air transport system, the investigation of the

accident must be competent, open, fair and timely. The ASC appears to us to have succeeded on all four counts. On the issue of timeliness you have been considerably quicker with your draft Final Report than either the United States with the investigation of TWA 800, or Canada with Swissair 111, both of which had many similarities to the CI611 investigation.

### **The Investigation**

The ASC, in working with the portion of the accident aircraft that was recovered and taking into account the damage from impact and transport, has the difficult and delicate task of drawing whatever conclusions that are relevant and supportable. The investigators have done a commendable job with the information that they were able to gather. Still, there are some parts of the analysis and conclusions that the CAA believes are too conjectural. Individual comments on those points are made in our detailed observations and recommendations. The CAA believes that the report would be clearer if the following general items were covered.

- Describe the tail-strike damage as clearly as possible including what is known about the length and depth of the scratches as well as the extent of the scratching. It would be helpful to be clearer on what wreckage was recovered and what was not recovered next to the scratched skin that was identified. It should be clear that only one surface of the major stress fracture was recovered. It should be clear that no scratching was found beyond the perimeter of the doublers.
- Describe the repairs, both temporary and permanent, and indicate what the industry practices were on skin scratch repairs at the time of the tail strike. It would give clearer context to the Report if the information were added from the Boeing 2003 Structures conference in Amsterdam. There, at least four other carriers reported scratching beneath repair doublers. It would also help if the recent information from Boeing about the dangers of skin scratches caused by metal tools were to be added to indicate that the understanding of aircraft skin scratching is still developing.
- The role of the Boeing representative could be clearer, particularly because the duties of the technical representative do not entirely match the expectations of the air carrier industry.
- The reader's understanding of the report would be facilitated if the deficiencies not related to the accident were clearly separated and identified.

Examples would be the quality of the riveting and the missed CPCP inspections.

- Where there is information supporting a conclusion and other information that is contradictory to the conclusion, both kinds of information should be included.
- Care should be taken in apparently judging actions taken in years past against more recent standards. An example is the rivet job on the repair doubler which was done over 20 years ago, but the job is discussed in the context of a 2001 standard. Where work is evaluated and found wanting, as in the instance of the rivets, it is important to note whether it was, in any event, effective. Nothing indicates that the over-driven or under-driven rivets compromised the security of the doubler.
- Where there is both a period of regulatory validity and a period of technical validity and they are not in agreement, it is important to note the effects of both. An example of this involves the CPCP inspection of the lower bilge area. The regulatory validity of the inspection had expired. However, the technical validity (four years from the previous corrosion inspection) had not expired at the time of the accident. The ASC should consider the two periods and express its opinion on which period of validity is more important for the safety of flight.

From the number of recommendations that you are proposing, it appears that there has been much learned from this investigation to eliminate, or at least reduce, safety risks within the air transport system. We believe that the ASC might be able to put greater persuasiveness into its recommendations by providing additional support for each of them. In the Report, as presented, one must go back into the analysis section of the Report to see the justification for each of the recommendation. That is something that not many readers are likely to do. We note that in the United States and Canada, recommendations come with considerable associated supporting information so that they can be read as 'stand alone' documents. In addition, those nations will add other relevant information as support for what has been derived from the specific investigation, that is, they will often cite the work of others to add support for what the particular investigation has found. You might wish to consider whether such practice would be appropriate for Taiwan.

## **The Aim of CAA Representations**

We have made our representations from the perspective of our organization and its work. We are, therefore, able to comment more extensively and with greater precision on those elements of your investigation that reflect on the CAA, its policies and its practices. For the most part, our representations relate to matters of accuracy and tone. In our review of the report we also noted spelling and typing errors. We have handled those by marking them in a copy of your Draft Report and sending it to you under separate cover in the hope that those notes, while not material to the accuracy or completeness of the Report, nevertheless will be helpful to you.

## **Safety vs. Enforcement & Liability**

We note with satisfaction that the ASC, in the introduction to the Report, is explicit in stating that the purpose of the Report is to enhance aviation safety and not to apportion blame or responsibility. In our view it is important to separate the safety investigation from other legitimate processes in order to encourage all those with knowledge of the accident and its circumstances to come forward to the ASC and give their information freely, openly and quickly. To highlight the non-regulatory and non-blaming nature of the report, the CAA suggests that the language of the report be reviewed to eliminate from the report the words that infer blame or regulatory infractions and replace them with safety-related terms. For example, terms such as 'evidence', 'failed to', and 'airworthiness' are legitimate and understandable, but they are often associated with the processes of litigation and enforcement. It would help to make plain the context of the report if those terms were replaced, where appropriate, with terms like 'information', 'did not', and 'structural safety'.

In the report there is considerable discussion of the maintenance requirements to keep older aircraft in safe flying condition. This is necessary to the understanding of the accident, but the report is structured in a way that it infers that missed corrosion inspections and the corrosion on recovered wreckage was, or may have been, material to the accident. It needs to be made very clear that no link was made between corrosion and the accident.

The description of the damage from the tail-strike, the repair and the remaining scratches is complex and difficult to describe. However, the report could be clearer on the location of the cracks that joined to become the long crack that

was determined to be the likely initiating point in the break-up of the aircraft. While, it is clear that there were a number of scratches under the doubler, one has to search the report to determine that the main crack developed under the doubler but between the outside row of rivets and the edge of the doubler.

The CAA believes the report would benefit significantly if the items related to the accident were clearly separated from the safety deficiencies that were noted in the investigation that are important but not related to the accident. The whole question of missed corrosion inspections is important, but they are not really related to the accident. For example, the heading with 1.6.6.2 describes 'delayed inspections', but it relates only to delayed corrosion inspections and the accident was associated with fatigue damage. More precision in that title would be helpful. Much is made of the late CPCP inspection as a lost opportunity to detect fatigue cracking. However, if one considers the philosophy of corrosion inspections as being time dependant rather than cycle dependant, the accident occurred less than four years after the last corrosion inspection. The significant number of items noted in that corrosion inspection suggests that it was thorough. Officially the next corrosion inspection was overdue, but that relates to a schedule that was overtaken by the December 1998 CPCP inspection and the documents were not amended to reset the time clock for the corrosion inspection, although they could have been. In other words, the CPCP inspection was overdue in accordance with the regulatory requirement, but it was not overdue in the technical safety context that considers the inspection as valid for four years.

### **Organization and Length of Report**

The Cl611 accident investigation Report covers a very complex recovery operation and a series of unusually sophisticated technical analyses. No doubt that makes the report necessarily long. However, if even more of the details of some of the investigation processes and descriptions of activities were moved to appendices, the report could become clearer and could be understood more easily. The amount of information already published in factual documents and appendices is exemplary and we believe that it will be of considerable value to investigators of subsequent large aircraft accidents.

### **Safety – Education vs. Punishment**

Possibly the most important comment that the CAA can make relating to aviation safety involves the choice between education and punishment. If accident



investigations are conducted and documented with a view to getting full information as quickly as possible, they should be conscious about not indicating normal human lapses as failures that invite punishment. If those working for manufacturers, carriers and regulatory agencies are concerned about being punished because they expose safety deficiencies in which they had a part, they have strong incentives to be less than forthcoming. The risk of punishment tends to leave unidentified safety problems hidden within the air transport system. The ASC conducts its interviews informally and not under oath. That represents the important presumption that those being interviewed will provide full and accurate information without coercion. That is the quickest way to identify any safety problems within the system and bring them into the light so that they can be fixed. If, in writing investigation reports, the language appears at all blameworthy, those being interviewed in future can be expected to be less forthcoming – which would be a serious safety problem. Punishment in aviation safety matters should be reserved for those who willfully conduct unsafe acts.

## SECTION 1 FACTUAL INFORMATION

No.	Original	Recommended Change
1	<p>Page 2</p> <p>Section 1.1: At 1516:24, Taipei Area Control Center, instructed CI611 to continue its climb, to maintain flight level 350, and to fly from CHALI direct to KALDO.</p>	<p>Issues/Discussion: Minor wording changes are proposed for increased accuracy.</p> <p>Recommended changes: At 1516:24, the Taipei Area Control Center controller instructed CI611 to continue its climb to flight level (FL) 350, and to maintain that altitude while flying from CHALI direct to KALDO.</p>
2	<p>Page: 3</p> <p>Section: 1.2 Table of Injuries</p>	<p>Issues/Discussion: The information is perfectly clear without the table.</p> <p>Recommended changes: Since the report is very long, consider eliminating the table that does not provide any information that is not already easily understandable.</p>
3	<p>Page: 5</p> <p>Section 1.5 – 1.5.3: Both the interview and medical records revealed that CM-1 was in good health and did not take any medication or drugs. He had a good relationship with his family and was well respected by his colleagues. He was on stand-by and was called for the flight the morning of the accident. He had more than 24 hours off-duty before the accident. He was the pilot in command and occupied the left seat.</p>	<p>Issues/Discussion: Issue: Information for CM-1, CM-2, CM-3. Identify “who” was interviewed for determination of information. Use same statement for each crewmember.</p> <p>Recommended changes: Based on interviews with the family and friends of CM-1, and the information retrieved from medical records, CM-1 was characterized as being in good health and did not take any medication or drugs.</p>
4	<p>Page: 8</p> <p>Section: 1.6.1.2: The fuselage of B747-200 is of semi-monocoque construction. In full monocoque construction, the skin carries the majority of the applied loads. In the B747-200 fuselage, applied loads are reacted by both the skin and by internal structure including frames, stringers, shear ties, and stringer clips. The fuselage station diagrams that describe the frame numbering are shown in Appendix 2.</p>	<p>Issues/Discussion: The second sentence, as written, would not be clear to non-technically trained readers.</p> <p>Recommended changes: Rewrite the second sentence to improve its clarity and replace the bolded word in the third sentence with the word ‘supported’.</p>

No.	Original	Recommended Change
5	<p>Page: 10</p> <p>Section: 1.6.1.3: Damage tolerance is an advanced structural philosophy that helps operators to detect structural damage, like fatigue, corrosion, etc., by scheduled inspections before the damage becomes critical. The federal Aviation Administration of the United States, FAA defines damage tolerance as:</p> <p><i>An evaluation of the strength, detail design, and fabrication must show that catastrophic failure due to fatigue, corrosion, manufacturing defects, or accidental damage, will be avoided throughout the operational life of the airplane.</i></p> <p>Therefore, in terms of damage growth and the effect of damage on structural strength, the manufacturers must conduct analyses and tests to quantify the level of damage that a structure might have to tolerate.</p>	<p>Issues: (1) The statement attributed to the FAA is not a definition.</p> <p>(2) Clarify the meaning of “regulatory loads”.</p> <p>Discussion:</p> <p>A previous version of this Report that quoted FAR 25.571 seemed more appropriate.</p> <p>At the paragraph headed “Residual Strength”, the term “regulatory loads” is not defined. Is this the same as “limit load” as defined in FAR 25.301, or is there some other meaning?</p> <p>Recommended change:</p> <p>Revert to earlier version that refers to FAR 25.571. Note bolded words to improve English. Define “Regulatory Loads”.</p>

<b>No.</b>	<b>Original</b>	<b>Recommended Change</b>
<b>6</b>	<p>Page: 12</p> <p>Section: 1.6.2.1: Based on a review of documents provided, CAL maintained the B18255 aircraft in accordance with the schedule of the CAA-approved B747-200 Aircraft Maintenance Program (AMP). The AMP work scope consisted of General Operation Specifications, Systems, Structure Inspection Program (SIP) and Corrosion Prevention and Control Program (CPCP). In order to maintain the airworthy condition of the aircraft, the components and appliances were maintained in accordance with specified time limits and cycles as stated in the AMP.</p> <p>Both the SIP and CPCP are parts of the AMP contents. The SIP specifies the minimum acceptable programs to assure the continuing structural integrity of the aircraft. The objective of the CPCP is to prevent corrosion deterioration that may jeopardize continuing airworthiness of the aircraft. To meet these requirements, the effectiveness of a CPCP is determined for a given aircraft area by the "level" of corrosion found on the principal structural elements during the scheduled inspections, and the need to conduct follow up repairs at an early stage.</p>	<p>Issues/Discussion: In the introduction to the report, there is a statement that "... the purpose of the investigation report is to enhance aviation safety, and not to apportion blame and responsibility ...". In light of that statement in this section and others, it would be preferable to state issues in safety terms rather than regulatory terms so that the tone of the entire report becomes related to safety then regulation and liability can be left to other processes and other reports.</p> <p>Recommended changes: The last sentence of the first paragraph should be reworded as follows:</p> <p>"To maintain the structural safety of the aircraft, the components and appliances were maintained in accordance with specified time limits and cycles as stated in the AMP."</p> <p>The third sentence of the second paragraph should be reworded as follows:</p> <p>"The object of the CPCP is to prevent corrosion deterioration that may jeopardize the structural safety of the aircraft."</p>
<b>7</b>	<p>Page: 13</p> <p>Section: 1.6.2.2: In accordance with the CAL's AMP description, the Boeing 747-200 aircraft required the following periodic inspections for its continuing airworthiness.</p>	<p>Issues/Discussion: The introductory sentence is in regulatory rather than safety terms.</p> <p>Recommended changes: In accordance with the CAL's AMP description, the Boeing 747-200 aircraft required the following periodic inspections for its continuing safe operation.</p>
<b>8</b>	<p>Page: 17</p> <p>Section: 1.6.3.1: Second "bullet": Replace "enforcing" with "reinforcing".</p>	<p>Issues: Replace word unless it is an accurate reflection of what is in the document referred to.</p>

<b>No.</b>	<b>Original</b>	<b>Recommended Change</b>
9	<p>Page: 19-20</p> <p>Section: 1.6.3.4: According to the CAL aircraft structure repair and tool / equipment drawing procedure, dated April 4, 2002, whenever an inspector finds a major defect or structural damage not described in SRM, the inspector will inform the System Engineering Department. The structures engineer will make an on-site evaluation and complete a preliminary sketch of the damage. A repair notice will be submitted to the aircraft manufacturer to obtain their repair scheme and drawing. The engineer will finalize the engineering drawings along with the Engineering Order and distribute them to the repair shop to complete the work. The Production Control Unit should file all the documentation with signatures.</p>	<p>Issues: Changes to improve English.</p> <p>Recommended change:</p> <p>Insert "bolded" changes.</p>
10	<p>Page: 19</p> <p>Section: 1.6.3.4: The reference to Paragraph 8.6 of Part 1, Chapter 8 in ICAO Annex 6 dated Jan 11, 2001.</p>	<p>Issues/Discussion: The reference to a document that became valid 20 years after the tail-strike can be misleading. The purpose of the reference should be clear.</p> <p>Recommended changes: If the reference is intended is to show that the ICAO requirement came along recently, it should be so stated. If it is for some other purpose, that too should be clear in the report.</p>
11	<p>Page: 21</p> <p>Section: 1.6.3.4: The remaining skin thickness must be 85 percent or above of the original thickness and the sum of the total length of damage is limited to 20 inches.</p>	<p>Issues:</p> <p>Earlier version of Report stated "The remaining skin thickness must be 90 percent or above..."</p> <p>Recommended Change:</p> <p>Identify correct value.</p>

<b>No.</b>	<b>Original</b>	<b>Recommended Change</b>
12	<p>Page: 30</p> <p>Section: 1.6.6.1: The paragraph beginning "The CAA-approved AMP required 47 CPCP items to be inspected...."</p>	<p>Issues: Not all readers will be knowledgeable concerning different inspection intervals based upon the phenomenon of the threat to the structure. In particular, the threat due to metal fatigue is associated with cycles of use: if the aircraft is not used, fatigue damage will not increase. On other hand, the threat due corrosion is substantially independent of use, but is dependent upon elapsed time. Therefore, corrosion-related inspections are generally based upon calendar times, not flight cycles or flight hours. A single sentence in this paragraph will be of help to some readers.</p> <p>Recommended change:</p> <p>At the end of the second sentence of this paragraph, insert: "Because the accumulation of corrosion damage is time-dependent, CPCP inspection intervals are specified in calendar times."</p>
13	<p>Page: 31</p> <p>Section: 1.6.6.1 (4<sup>th</sup> paragraph): In 1996, the CAL Maintenance Planning Section (MPS) of the System Engineering Department became aware that all scheduled CPCP inspection items in the letter checks might cause inspection overdue (Appendix 9). At the same period of time, the MPS issued an internal memorandum (Appendix 10) to the Maintenance Operation Center (MOC) of the Line Maintenance Department, and asked the MOC to notify the MPS when the CPCP inspection items were approaching the scheduled inspection intervals.</p>	<p>Issues/Discussion: Some rewording is required for clarity.</p> <p>Recommended changes: In 1996, the CAL Maintenance Planning Section (MPS) of the System Engineering Department became aware that all scheduled CPCP inspection items in the letter checks might lead to late inspections (Appendix 9). At the same time, the MPS issued an internal memorandum (Appendix 10) to the Maintenance Operation Center (MOC) of the Line Maintenance Department, and asked the MOC to notify the MPS when the CPCP inspection intervals were approaching.</p>

No.	Original	Recommended Change
14	<p>Page: 32</p> <p>Section: 1.6.6.2:</p> <p>Note to the ASC:</p> <p>At the time of the 12/28/98 inspection there were two possible cases:</p> <p>(i) the crack was below detectable limits;</p> <p>(ii) the crack was detectable, but the inspection procedure failed to detect the crack.</p> <p>If (i), the crack grew to a critical extent within the timeframe of the inspection period. Thus the inspection period should be reduced.</p> <p>If (ii), the crack grew over some unknown time, but the failure occurred within two inspection periods. Again, the inspection period should be reduced to give at least two opportunities to detect a crack before it leads to catastrophic failure.</p> <p>One must remember, however, that the CPCP was not intended as an inspection procedure to find fatigue cracks, but rather was designed to identify corrosion problems.</p>	<p>Issues/Discussion: The points in the note, if included in the report, may make the corrosion vs. fatigue issue clearer to the reader.</p>
15	<p>Page: 36-38</p> <p>Section: 1.6.6.3: Regulations Article 40.</p>	<p>Issues/Discussion: The citing of these regulations brings a regulatory tone to the report.</p> <p>Recommended changes: Remove the long list of regulations and simply note that CPCP is considered to be such an important safety program that regulations make it non-discretionary.</p>
16	<p>Page: 41</p> <p>Section: 1.6.9, Para. 3: According to the Aircraft Flight Operation Procedures of the Civil Aeronautics Administration in 1976:</p> <p><i>Article 46</i> to end of section.</p>	<p>Issues/Discussion: The first paragraph of the section explains the issue. Including the detailed procedures does not add to the report.</p> <p>Recommended changes: Delete the detail of article 46.</p>

<b>No.</b>	<b>Original</b>	<b>Recommended Change</b>
<b>17</b>	<p>Page: 49</p> <p>Section: 1.6.11.2: Figure 1.6-14 shows the bilge before corrosion inhibit compound and dust was removed of a B747-400 freighter. The stain on the lower lobe skin cover part of the paint. The bilge was covered with dirt and residue that on two adjacent insulation blankets in the bulk cargo lower lobe bay.</p>	<p>Issues:</p> <p>Wording is incorrect.</p> <p>Recommended change:</p> <p>Figure 1.6-14 shows the bilge before corrosion inhibit compound and dust was removed from a B747-400 freighter. The stain on the lower lobe skin cover part of the paint. The bilge was covered with dirt and residue that covered two, adjacent insulation blankets in the bulk cargo lower lobe bay.</p>
<b>18</b>	<p>Page: 64-65</p> <p>Section: 1.12.1, Para. 2: Once a wreckage piece was recovered, either floating or from the seabed, a number was immediately assigned in numeric order. For instance, item 623 means this item was number 623 in the recovery sequence. The C number means that a particular piece has been cut because of testing, or for the convenience in shipping/transportation. Several batches of numbers were reserved initially for smaller pieces but were considered not relevant to be numbered, or reserved for the wreckages recovered from different locations or different means, but were not used.</p>	<p>Issues/Discussion: The final sentence of the paragraph is difficult to follow and should be rewritten for clarity.</p> <p>Recommended changes: Several batches of numbers were initially reserved for identifying the smaller wreckage pieces, but the numbers were not used because the investigators determined that the small pieces did not justify individual identification by location or by means of recovery.</p>
<b>19</b>	<p>Page 71</p> <p>Section 1.12.4: "Shallow dents and varying shades of blue marks were found along the leading edge of the LHS stabilizer." These were determined to be "not from aircraft exterior finishes". It was further determined that these marks did not match with interior components.</p>	<p>Issues:</p> <p>These comments concerning marks on the LHS at the leading edge indicate that this concern is not "closed". The reader is left with the idea that this is an item that has not been satisfactorily resolved.</p> <p>Recommended change:</p> <p>If this matter is considered to be inconsequential, delete this paragraph. Otherwise, explain the origin of the blue marks.</p>
<b>20</b>	<p>Page: 77</p> <p>Section: 1.12.6.1: Begins with APU Panel on P77 and ends with Clock on P78.</p>	<p>Issues/Discussion: In describing the switch positions terms like; "set to", "was in", "in" etc., imply that the crew set, or may have set them in those positions.</p> <p>Recommended changes: A neutral term like 'was found in' leaves open all possibilities and fits better with the analysis in the Analysis section of the Report.</p>



<b>No.</b>	<b>Original</b>	<b>Recommended Change</b>
<b>21</b>	<p>Page: 83</p> <p>Section: 1.16.2 begins with: On November 2, 2002, seven aircraft systems components were sent to the Boeing Equipment Quality Analysis (EQA) laboratory in Seattle, Washington, for detailed examinations. The EQA laboratory has specialized equipment and personnel to examine aircraft parts. ASC personnel, together with the personnel from Boeing, NTSB, and CAL participated in the examinations. The key system components been tested including:</p>	<p>Issues/Discussion: It is clear that the ASC and others attended tests done by manufacturers and others who might have an interest in the findings of the tests. It is not clear whether the ASC had control of the components during the testing. For example, were the tested components opened at the manufacturer's facility by or in the presence of the ASC? Were they locked up at the end of each day with a lock controlled by the ASC?</p> <p>Recommended changes: If the ASC controlled the testing described in this and subsequent sections, it would be worth noting in the Report.</p>
<b>22</b>	<p>Pages: 108 to 115 incl.</p> <p>Section: 1.17.3</p>	<p>Issues:</p> <p>A substantial amount of new material. Generally this is a clearly written section, but some errors in English remain. At no point, however, does it appear that the CAA states that one of their primary responsibilities is to approve the CAL Maintenance Program and, presumably, to audit CAL against the contents of their Maintenance Procedures Manual.</p> <p>Recommended Change:</p> <p>Suggest adding a clear statement of CAA responsibility with respect to approving the CAL Maintenance Procedures Manual.</p>
<b>23</b>	<p>Page 110 –112</p> <p>Section: 1.17.3.5</p>	<p>Issues/Discussion:</p> <p>This is a rather complete listing of the functions, duties and responsibilities of the CAA Airworthiness Branch. However, we are unable to identify two important functions among those listed. First, is it not true that a major function of the CAA is to conduct Audits? Secondly, the approval of the AMP would also appear to be a major task and responsibility.</p> <p>Recommendations:</p> <p>Add Audits and Maintenance Manual Approvals to the list of tasks and responsibilities.</p>

<b>No.</b>	<b>Original</b>	<b>Recommended Change</b>
24	<p>Page: 114</p> <p>Section: 1.17.3.7, Para. 2: For the past few years, ICAO has been conducting audits of ICAO Member States regarding compliance with the provisions of Annexes 1 (Personnel Licensing) 6 (Operations), and 8 (Airworthiness). Virtually all Member States have received at least one audit, which assesses a State's ability to meet its safety oversight obligations contained in the SARPs of those particular Annexes. ICAO does not assess ROC's safety oversight programs because the ROC is not a member of ICAO.</p>	<p>Issues/Discussion: The sentence about ICAO membership almost suggests that membership is at the discretion of the ROC. Since the exclusion of the ROC is a clear safety problem, that fact should be emphasized in the Report.</p> <p>Recommended changes: For the past few years, ICAO has been conducting audits of ICAO Member States on compliance with the provisions of Annexes 1 (Personnel Licensing) 6 (Operations), and 8 (Airworthiness). Virtually all Member States have received at least one audit, which assesses a State's ability to meet its safety oversight obligations contained in the SARPs of those particular Annexes. ICAO refuses to assess the ROC's safety oversight programs because the ROC has been excluded from ICAO membership.</p>
25	<p>Page 133</p> <p>Section: 1.18.4: After reviewing the current ditching procedures of the China Airlines B747-200 (SP) "Airplane Operations Manual", the Safety Council found that on page 2.10/43a (Figure. 1.18-6) and on page 4.75/9-10 (Figure.1.18-7) which define the ditching procedures are different. The ditching procedures on Page 4.75/9-10 has one additional step than the one on page 2.10/43a, whereas step "Equipment Cooling Valve Sw..... Ditch" on page 4.75/10 is missing on Page 2.10/43a. The ditching procedures in the China Airlines B747-200 "Quick Reference Handbook" are the same as the one in Page 2.10/43a without the additional step.</p>	<p>Issues/Discussion: The information provided on ditching has little, if any, contextual relationship with the accident.</p> <p>The information is not supported in the analysis and may confuse the reader into thinking the investigation believes that the crew was executing the ditching checklist.</p> <p>Recommended changes: Either delete the section or make clear that the inconsistency in the manuals is a safety issue unrelated to the accident.</p>

## SECTION 2 ANALYSIS

No.	Original	Recommended Change
26	<p>Page 145</p> <p>Section 2.1 – last paragraph</p> <p>Based on the information presented in Chapter 1, the Safety Council concludes that the in-flight breakup of CI611 was due to structural failure. A combination of analytical methods was used to rule out the remaining possible scenarios as described in the following subsections. After careful observation of the FDR data before its power loss, the Safety Council also analyzes the phenomenon exhibited.</p>	<p>Issues/Discussion: The time that the power stopped coming to the FDR and the time that it quit picking up data, while very close, may not be identical. For accuracy it would be better to delete the words 'before its power loss', in the final sentence. In the same sentence the words '... the Safety Council also analyzes the phenomenon exhibited' are not understood.</p> <p>Recommended changes: Delete the above-noted words and make clear what phenomenon or phenomena were subjected to analysis.</p>
27	<p>Page 145 – 148</p> <p>Sections 2.1.2 – 2.1.9: The terms 'a cause', 'the cause', 'a causal factor' and 'the causal factor' are used apparently interchangeably.</p>	<p>Issues/Discussion: Cause as used in describing a scientifically certain event is very restrictive. The Term 'cause' is used in litigation with a much lower degree of certainty. Both uses are legitimate in their appropriate contexts. However, in accident investigation reports the term cause is often used without apparent indication of the standard of certainty being used. The absence of a clear understanding of what is meant by the term often leads to unnecessary difficulties in the litigation that usually follows an accident. Where practicable it is preferable to use a term other than cause.</p> <p>Recommended changes: Replace references to cause in these sections with an unambiguous term such as; 'were (or was) not a factor'.</p>
28	<p>Page 148</p> <p>Section 2.1.9, final paragraph: The accelerometers of the Boeing 747 are mounted along STA 1310, which is near the center of gravity of the aircraft. Purpose of the accelerometers is to measure the maneuvers (forces) of the aircraft, not for the use to measure structural frequencies of the fuselage. With the limited amount of data available, the Safety Council can not be certain whether this slight increase in the vertical acceleration was the structural content in pitch direction, or caused by some other unknown phenomenon.</p>	<p>Issues/Discussion: The section would benefit from rewording for clarity.</p> <p>Recommended changes: On the Boeing 747 the accelerometers are mounted along STA 1310, which is near the aircraft's center of gravity. These instruments measure accelerations of the aircraft associated with maneuvering, turbulence etc. They do not accurately measure the frequencies of vibrations that may pass through the fuselage. With the limited data available, the Safety Council could not determine what led to the slight increase in vertical acceleration just before the aircraft broke-up.</p>

No.	Original	Recommended Change
29	<p>Page 150-151</p> <p>Section 2.2.1.1: After examining wreckage items 640 and 630, the Safety Council concludes that the May 1980 repair to the tail strike damage area of B18255 was not accomplished in accordance with the Boeing SRM. Specifically, the Boeing SRM required that scratches in the damaged skin within allowable limits should be blended out, or if the damage was too severe and beyond allowable limits, the damaged skin had to be cut off and a doubler was to be installed, or the old skin was to be replaced with piece of new skin. However, the damaged skin of B18255 was beyond allowable limit and there were still scratches on the skin underneath the doublers.</p> <p>When the belly section of the recovered wreckage in both Sections 46, and 48 were examined, three repaired doublers were found, including one in Section 46, and two in Section 48. The two doublers in section 48 were in the unpressurized area as described in 1.12.10. After removing the doublers, the Safety Council found similar scratch patterns on the skin covered by the repair doublers comparable to the skin around STA 2100. The skin underneath repair doubler-2 had been cut off. The record shows that scratch marks in sections 46 and 48 occurred as the result of the 1980 tail strike (Appendix 3). However, no records can be found regarding the two repair doublers in Section 48 (the November 2001 RAP data collection only covered the pressurized area of the fuselage), the Safety Council believes that those two Section 48 doublers were either installed at the time of the temporary repair or permanent repair of Section 46 at STA 2100.</p>	<p>Issues/Discussion: Some rewriting would make the section clearer, particularly in the second paragraph. Rather than assuming when the Section 48 doublers were installed, suggest the Safety Council simply say they do not know when they were installed.</p> <p>Recommended changes: After examining wreckage items 640 and 630, the Safety Council concluded that the May 1980 repair to the tail strike damage did not meet all the requirements of the Boeing SRM. Specifically, the Boeing SRM required that scratches in the damaged skin, if small and not deep, should be blended out. The scratches in the damaged skin of B18255 exceeded the allowable limit and after the repair there were still scratches on the skin underneath the doublers.</p> <p>When the belly section of the recovered wreckage in both Sections 46 and 48 were examined, there were three repair doublers, one in Section 46, and two in Section 48. The two doublers in Section 48 were in the un-pressurized area as described in 1.12.10. After removing the doublers, the Safety Council found scratch patterns on the skin covered by the Section 48 repair doublers that were comparable to the skin around STA 2100. The record shows that scratch marks in Sections 46 and 48 occurred as the result of the 1980 tail strike (Appendix 3). However, no records were found on the two repair doublers in Section 48 (the November 2001 RAP data collection only covered the pressurized area of the fuselage), the Safety Council was unable to determine when the two Section 48 doublers were installed.</p> <p>Note: In Section 1.6.3.1 the Boeing BFSTPE refers to patches in the plural, which likely refers to the Section 48 doublers as well as the Section 46 doubler.</p>

No.	Original	Recommended Change
30	<p>Page152</p> <p>Section 2.2.1.2, para. 4: Examination of wreckage item 640 Indicated that the length of the scratches on the damaged skin was more than 20 inches in a 20 -inch-square area, and the depth of scratches were more than 15% of the skin thickness. The damage was beyond the allowable damage specified by the SRM. Repairs could be made by replacing the entire affected skin or cutting out the damaged portion and installing a reinforce doubler to restore the structure strength. Instead of either of these acceptable options, a doubler was installed over the scratched skin. In addition, the external doubler did not cover the entire damaged area as scratches were found at and outside the outer row of fasteners securing the doubler.</p>	<p>Issues: This appears to be a key section in explaining the accident. The critical crack developed under the doubler but outside its perimeter rivets, rendering the area invisible from the exterior of the aircraft but unsupported by the doubler.</p> <p>Discussion: It is important to make the situation stand out so that readers will not miss what happened.</p> <p>Recommended changes: Examination of wreckage item 640 shows that the scratches on the damaged skin were more than 20 inches long in a 20-inch-square area, and the depth of scratches was more than 15% of the skin thickness. The damage was beyond that allowable by the SRM. Replacing the entire affected skin was the only way to make the repairs in accordance with the SRM. When the doubler was installed with some scratches outside the rivets, there was no protection against the propagation of a concealed crack in the area between the rivets and the perimeter of the doubler.</p>
31	<p>Page 152</p> <p>Section 2.2.1.2, para. 5: Today, CAL uses the logic flow chart in Figure 1.6.6 as the guideline to determine if the repair can be qualified as a major or minor repair. According to the interview records, regarding the classification of the 1980 repair, if utilizing the decision process as described in Figure 1.6.6, CAL replied that the 1980 repair would still be classified as a “minor” repair. However, since the 1980 tail strike damage was too severe, it was beyond the allowable limits (allowed to reduce structure strength within certification limits), the repair was not done using simple repair with strength reduction methods (must be within certification limits). In other words, it was too severe to adopt the method of a “minor” repair. Rather, it used a complex repair to restore its strength i.e., to install a reinforcing doubler. Therefore, by using the same logic flow chart as described in Figure 2.2-1, the Safety Council would definitely classify the 1980 tail strike repair as a “major” repair. In addition, the FAR Part 43 (1989) definition of major repair should also apply to the 1980 tail strike repair.</p>	<p>Issues/Discussion: Footnote 16 makes plain that the CAA has classified all skin patches on the pressure hull as major repairs. It really does not matter what individuals may have said during interviews, the requirement is now clear for any ROC carrier. The references to testimony that is contradictory to current CAA directives tend to confuse the reader.</p> <p>It is not fair to the carrier or the CAA to refer to the 1989 definition of a major repair. The repair was carried out nine years earlier.</p> <p>Recommended changes: Delete all except the first sentence of the paragraph 5 of the section to the point where the logic chart (2.2-1) is mentioned. Also delete the final sentence, as one cannot logically apply a 1989 definition to 1980 circumstances.</p>

<b>No.</b>	<b>Original</b>	<b>Recommended Change</b>
<b>32</b>	<p>Page 154</p> <p>Section 2.2.2, Para. 1 &amp; last Para.: According to interview records, CAL maintenance personnel would still categorize the 1980 tail strike repairs as a “minor” despite CAA regulations, For minor repair, CAL personnel indicated that it was not necessary to inform the Boeing FSR because it would simply follow the SRM procedure to complete the repairs. CAL also indicated that it was not necessary to keep the relevant maintenance records for minor repairs. According to interview of the Boeing FSR at the time of the accident (retired), he stated, “if the repair was to be conducted in accordance with the SRM, then it was not necessary for CAL to inform the Boeing FSR regarding the permanent repair. CAL would inform Boeing FSR only if there were a problem or difficulty in the repairing process. Since the tail strike repair was not a complex repair, the CAL did not inform the Boeing FSR of the permanent repairs of the 1980 tail strike.”</p>	<p>Issues/Discussion: Note 16, invalidates the first two lines of the paragraph.</p> <p>Recommended changes: Delete the first two lines of Paragraph 1.</p>
<b>33</b>	<p>Page 157</p> <p>Final Para.: The Safety Council finds that communication between CAL and the Boeing FSR has improved dramatically as the relationship between the operator and the manufacturer has grown more mature. If the similar tail strike occurs today, a more proactive attitude of the FSR to assist the operator in problem solving will be imminent. However, if CAL still considers such a tail strike as a minor repair, then neither the manufacturer’s FSR nor the CAA inspectors will be involved. The Safety Council believes that when assessing damage caused by an occurrence, CAL should hold counsel with manufacturer to educate the staff how to categorize the type of the repair and carefully assess its repair method with safety as the number one priority concern by using the adequate maintenance repair methods.</p>	<p>Issues/Discussion: The third sentence in the final paragraph of the section invalidates the third paragraph.</p> <p>Recommended changes: Delete the third sentence which starts “However, if CAL still considers ... “</p>

No.	Original	Recommended Change
34	<p>Page 164</p> <p>Section 2.3.1.2, Final Para.: However, the hypothesis that the regular spaced marks, consistent with the pressurization cycles indicates “quasi-stable crack growth” is not a mature theory. On the other hand, the determination of the causes of the deformed cladding might be related to other unknown factors (post-damage to the fracture surface for example). The same situation might also occur in the determination of the causes of the regular spaced marks, especially at the forward and aft ends of the crack. Therefore, to be more conservative, the Safety Council believes the length of the pre-existing cracking should be about 71 inches, instead of 93 inches, as indicated in the BMT report.</p>	<p>Issues: The conservatism of the ASC is noted, but there is little to indicate why a crack length of ‘about 71 inches’ was selected. Some minor wording changes would also make the paragraph clearer.</p> <p>Discussion: With the uncertainty of the theory, it would likely be better to express the pre-existing crack length as a range of between --- and -- inches. The high end of the estimate could be from the BMT estimate of 93 inches and the low-end number should be supported by clear rationale. If the BMT estimate is rejected, it should be done with clear rationale, i.e. more specific than just to be conservative.</p> <p>Recommended changes: The hypothesis that the regular spaced marks, consistent with the pressurization cycles indicates “quasi-stable crack growth” has not been confirmed. The deformed cladding might also be related to unknown factors (e.g. post-accident damage to the fracture surface). The origin of the regularly spaced marks is also unclear, especially at the ends of the crack. Therefore, the Safety Council believes the length of the pre-existing cracking should be estimated to be in the range of about -- to -- inches.</p>
35	<p>Pages 166-168</p> <p>Sections: 2.3.2.2 through 2.3.3.1: The cabin pressure load was carried by hoop tension in the skin with no tendency to change shape or induce frame bending. Normal operating differential pressure, 8.9 psi, representing the cabin/ambient pressure difference at FL350, was used for the analysis in this section.</p> <p>Strain gages installed during a factory pressure test of B747-200 fuselage in Boeing showed that the model overestimated the skin stress by 6%, therefore the reference operating stress used for the skin calculations is corrected. This corrected stress is used in all of the calculations and is represented in the charts included in following subsections.</p>	<p>Issues/Discussion: The information is primarily a restatement of facts presented in the factual section. The facts presented in these sections are not analyzed significantly and do not culminate in conclusions.</p> <p>Recommended changes: Consolidate this information with other relevant information that will culminate in significant conclusions or consider integrating this with other factual information in section 1.</p>

No.	Original	Recommended Change
36	<p>Page 173</p> <p>Section 2.3.4: The pre-existing cracking on Item 640 was at least 71 inches. The frame capability analysis indicates that the STA 2100 frame failsafe chord is approaching its ultimate capability as the skin crack grows past 71 inches and reached its limit at 83 inches. If the central frame fails, the skin assembly would certainly be subjected to an unstable separation with the pre-existing cracking identified in the laboratory.</p>	<p>Issues/Discussion: At the end of 2.3.1.2, the pre-existing crack is described as 'about 71 inches'. Here it has become 'at least 71 inches'.</p> <p>Recommended changes: The inconsistency needs to be resolved.</p>
37	<p>Page 173-174</p> <p>Section 2.3.4: Figure 2.3-17 combines the above results in safety margin to discuss both the capability of the frame and skin with the crack length. This figure indicates that the safety margin of the failsafe chord and the skin have the same trend, both decrease steeply before the crack reaching the two-bay length (40 inches) and then move slower as the safety margin approaching zero. The frame and skin structure becomes more and more unstable as the safety margin getting close to or below zero. With the amount of identified damage, 71 inches of pre-existing cracking, the skin and frame were both at the limits of capability under normal operational load condition.</p>	<p>Issues/Discussion: The reference to the safety margin becoming 'below zero' cannot be correct. The assertion that there was a pre-existing crack of 71 inches should also be reviewed in light of the uncertainty of that number.</p> <p>Recommended changes: Figure 2.3-17 combines the above results in safety margin to discuss the residual strength of both the frame and skin with the crack. This figure indicates that the safety margin of the failsafe chord and the skin both decrease steeply before the crack reaches the two-bay length (40 inches) and then less steeply as the safety margin approaches zero. The frame and skin structure become increasingly unstable as the safety margin approaches zero. With the range of identified damage, -- to -- inches of pre-existing cracking, the skin and frame were both at the limits of their load bearing capability under normal operational loads.</p>
38	<p>Page 174</p> <p>Section 2.3.4, final Para.: The corrosion, as indicated in Section 1.16.3, found on the inboard skin underneath the shear ties of STA 2100 and STA 2080 should also reduce the residual strength to a certain degree. However, since a major portion of the section 46 wreckage adjacent to item 640, was not recovered, the Safety Council cannot determine the nature and degree of corrosion on the lower aft lobe of the fuselage. Therefore, its influence to the reduction of the residual strength is not computed.</p>	<p>Issues/Discussion: The corrosion found on the inboard skin under the shear ties of STA 2100 &amp; 2080 would reduce the strength of the skin only if it was not covered by the doubler. Since the doubler was covering the corrosion, it should be clear that the identified corrosion had no bearing on the accident.</p> <p>Recommended changes: The corrosion, as indicated in Section 1.16.3, found on the inboard skin under the shear ties of STA 2100 and STA 2080 would have no effect on the residual strength of the hull because it was covered by a doubler. However, since a major portion of the section 46 wreckage adjacent to item 640, was not recovered, the Safety Council cannot determine whether there was other corrosion on the lower aft lobe of the fuselage.</p>



No.	Original	Recommended Change
39	<p>Page 182</p> <p>Section 2.5.2, Para 2: A possible explanation for the flight crew to place the “pack” valves selectors into the “Close” position is a pressurization system malfunction, however, the pressurization system malfunction issue can be discounted due to lack of conversation among the flight crew recorded on the CVR regarding over pressurization in cabin.</p>	<p>Issues/Discussion: This possibility is so remote that it tends to distract from the credibility of the analysis. The explosive decompression associated with the break-up of the aircraft would have produced a short-lived vapor cloud. By the time it cleared the aircraft would have been tumbling and the effects of anoxia would have quickly incapacitated the crewmember.</p> <p>Recommended changes: Delete the final two sentences of the paragraph.</p>
40	<p>Page 182</p> <p>Section 2.5.2, final Para.: Another possibility is the flight crew was conducted the ditching procedure. The Ditching Procedure defined in China Airlines B747-200(SP) “Airplane Operations Manual” are shown in Figure 2.5.3 Based on the procedures defined on Figure 2.5-3, the emergency ditching procedure does not include switching off number 1 and number 2 engine bleed air valves. Further, the equipment cooling valve control switch was not activated based on the wreckage examination results as shown in Figure 2.5-4. The Safety Council does not have sufficient information to support that the flight crew conducted ditching procedure after the flight recorders lost their power.</p>	<p>Issues/Discussion: The speculative and extremely remote possibility of ditching procedure is not justified. Even if the crew was not yet incapacitated, the aircraft would have been subjected to severe uncontrolled movements (the engines came off) and the notion of conducting a ditching procedure in these circumstances is entirely conjectural.</p>
41	<p>Page 194</p> <p>Section 2.6.4, end of first Para.: Unfortunately, the CVREA cannot predict with confidence the position of the break-up of the CI611 accident.</p>	<p>Issues/Discussion: This statement is in conflict with the conclusion on p 196.</p> <p>Recommended changes: The change should be made on p 196.</p>
42	<p>Page 196</p> <p>Section 2.6.4, end of last Para: If the break-up area is at non-pressurized area, the fuselage structure will behave like a sound insulator that reduces the sound energy to CAM. In this case the event sound level would be less than the precursor level. In the case of CI611, the event sound level is much higher than the precursor sound level. Thus, the Safety Council concludes that the structure break-up area was at pressurized area.</p>	<p>Issues/Discussion: The consensus in the accident investigation community is that the CVREA cannot predict with confidence the location of an explosion or break-up. It would be appropriate to bring this paragraph into line with that consensus.</p> <p>Recommended changes: If the break-up began in a non-pressurized area, the fuselage structure would behave like a sound insulator and reduce the sound energy to the CAM. In this case, the event sound level would be less than the precursor level. In the case of CI611, the event sound level is much higher than the precursor sound level. However, with the unreliability of the information, the Safety Council can draw no conclusion on where the break-up began.</p>

No.	Original	Recommended Change
43	<p>Page 197</p> <p>Section 2.6.5: Based on above analysis, conclusions are made as follows:</p> <ol style="list-style-type: none"> <li>1. Based on time correlations analysis of TACC air-ground communication recording, the CVR and FDR recordings, both CVR and FDR stopped at the same time of 1527:59±1 second.</li> <li>2. Except the last sound spectrum, all other sounds from the CI611 CVR recordings yield no significant information to this investigation of this accident.</li> <li>3. The Safety Council concludes that the origin of the sound of CI611 was in a pressurized area. This conclusion is based on both the sound spectrum analysis of the last 130 ms before power cut-off, as well as the power cut-off of the two recorders occurred nearly at the same time.</li> </ol> <p>The sound spectrum from the recorders of CI611 aircraft did not provide sufficient information for accident investigation. Similar situation happened in TWA800, UA811 or other abrupt in-flight breakup accidents. The Safety Council believes that if there were back-up CVR and FDR installed nearby the cockpit with Recorder Independent Power Source (RIPS), more information could be provided to the investigators.</p>	<p>Issues/Discussion: Changes made to the body of section 2.6 invalidate two of the three conclusions.</p> <p>Recommended changes: Based on above analysis, conclusions are made as follows:</p> <p>Time correlation analysis of the TACC air-ground communication recording, the CVR and FDR recordings, indicate that both CVR and FDR stopped at the same time of 1527:59±1 second.</p> <p>The Safety Council was unable to conclude where the sound signature at the end of CI611 CAM recording originated.</p> <p>The sound spectrum from the recorders of CI611 aircraft did not provide sufficient information for accident investigation purposes. A similar situation happened in TWA800, UA811 and other abrupt in-flight break-up accidents. The Safety Council believes that if there were back-up CVR and FDR installed nearby the cockpit with Recorder Independent Power Source (RIPS), more information might be provided to the investigators.</p>

No.	Original	Recommended Change
44	<p>Page 230</p> <p>Section 2.9.4.1 (2<sup>nd</sup> Paragraph) The Safety Council understands that when a continuing airworthiness requirement is introduced, the operators need to consider numerous factors, such as the degree of urgency of the unsafe condition, the amount of time necessary to accomplish the required actions, the maintenance schedules, etc., to decide when and how to adopt the requirements. However, the Safety Council also believes that when operators receive a safety related airworthiness requirement, the operators should assess and implement the requirement at the earliest practicable time. A review of accidents in aviation history reveals that several accidents could be attributed to a modification prescribed in the airworthiness requirements/service bulletin that had not been incorporated into the aircraft before the accident. It is not necessary to wait until the deadline to implement the modifications.</p>	<p>Issues/Discussion: In the view of the CAA, the ASC is proposing activities for the operator that are beyond those contemplated in the international aviation safety system. When an unsafe condition is identified, the remedial action and its timing are normally determined by the manufacturer in conjunction with the state of manufacture. When the time to take the remedial action is set, the manufacturer and the state of design are asserting that it can be safely completed up to and including the last day allowed. The skill required to identify remedial action and its timing is normally neither present nor intended to be present in an operator's organization. The operator is expected to rely on the safety judgments of the manufacturer and the state of design</p> <p>Recommended changes: Delete the reference to the operator assessing degree of urgency and the timing for taking remedial action to eliminate the unsafe condition.</p>
45	<p>Page 231</p> <p>Section 2.9.4.2 (starting 2<sup>nd</sup> Paragraph): The FAA mandated the RAP by amending four operational rules, 14 CFR Parts 91.410, 121.370, 125.248, and 129.32. The rules became effective on May 25, 2000. These operational rules are "mandatory continuing airworthiness information" as defined by ICAO Annex 8, paragraph 4.3.2. The basic statement in each rule is that no person may operate [one of the affected models] beyond the applicable flight cycle implementation time, unless repair assessment guidelines have been incorporated within its inspection program. The FAA gave final approval to Boeing RAG documents in February 2001.</p>	<p>Issues/Discussion: The Repair Assessment Program (RAP) was included in the operator's maintenance program as required by ICAO Annex 8 paragraph 4.3.3. All other mandatory continuing airworthiness requirements have also been adopted in accordance with Annex 8. Therefore, none of the FAA referenced regulations have current effect on ROC registered aircraft. The inclusion of non-pertinent regulations in the report may mislead readers of the report rather than clarifying information for them.</p> <p>Recommended changes: Delete the FAA referenced regulations and retain subsequent references to ICAO Annex 8.</p>

No.	Original	Recommended Change
46	<p>Page 232</p> <p>Section 2.9.4.2 (Paragraph following reference to ICAO Annex 8): Interview records indicated that the CAA was aware of the RAP in 2000. However, the CAA stated that because there were only a few aircraft that would fall into the aging aircraft category in Taiwan, the CAA did not take any action to adopt the program into the system immediately. When the CAL proposed its RAP to the CAA, the CAA accepted the program and requested CAL to provide RAP related introduction or training to the CAA airworthiness inspectors.</p>	<p>Issues/Discussion: The information presented is incomplete and may mislead readers. The CAA instructed CAL to instruct their training personnel to develop a course for their maintenance personnel. The CAA required notification from CAL when the training was going to be conducted. The CAA also indicated that it would monitor the training to ensure that it gave effective coverage of the program, which is standard procedure for all initial training provided by an operator.</p> <p>Recommended changes: Revise the paragraph to reflect the CAA's actions in conducting its oversight of the training.</p>
47	<p>Page 232</p> <p>Section 2.9.4.2 (Next to last paragraph) Since CAA did not issue any form of documentation to request operators to adopt the RAP, the RAP was not a mandatory program in Taiwan. Nevertheless, CAL decided to incorporate the program into its maintenance program based on the CAL's own assessment. Although CAL had initiated the RAP within the timeframe specified in the FAA amended rules, the Safety Council concludes that the CAA had not given formal consideration to monitoring the introduction of the RAP and making it mandatory for all R.O.C. operators, until after the accident.</p>	<p>Issues/Discussion: The paragraph is not valid because the ROC's registry did not list any aging aircraft other than CAL's five B747-200s. Thus, there were no other aging aircraft operators to notify. Additionally, the CAA Flight Operations Regulations, (AOR) Article 137, requires operators to comply with any continuing airworthiness requirements. CAL had incorporated the Repair Assessment Program (RAP) into its maintenance program in accordance with ICAO Annex 8. The CAA approved CAL's RAP on May 28, 2001, approximately a year before the accident.</p> <p>Recommended changes: Delete the paragraph.</p>
48	<p>Page 235</p> <p>Section 2.9.5.2 (Final paragraph) CAA regulations require CAL to be responsible for ensuring that the approved maintenance program is complied with. CAL did not have adequate procedures to assure complete compliance with the CPCP inspection intervals. Consequently B18255 was operated with unresolved airworthiness safety deficiencies from November 30, 1997 to May 25, 2002. CAL's EMD and self-audit system did not detect or ensure that all requirements of the CPCP program were met.</p>	<p>Issues/Discussion: The paragraph contains wording that suggests regulatory judgments by the ASC.</p> <p>Recommended changes: Amend the third sentence to read: Consequently B18255 was operated with safety deficiencies related to corrosion inspections for approximately four and a half years.</p>

No.	Original	Recommended Change
49	<p>Page 236</p> <p>Section 2.9.5.3 (5<sup>th</sup> Paragraph) The CPCP 4-year interval item made B18255 operated with a significant safety deficiency from November 30, 1997 to Dec 28, 1998. Since this date CAL's CPCP control program started to deteriorate. Even though the bilge inspection was conducted in December 1998, the 5-year interval items came due in 1999 and made the aircraft late in corrosion inspections again. The items to be inspected at every 6 and 8 years made B18255 late in corrosion inspections from November 1999 to May 25, 2002. The Safety Council concludes that B18255 was operated with unresolved airworthiness safety deficient condition from November 30, 1997 to May 25, 2002, except for the period from January 1999 to November 29, 1999.</p>	<p>Issues/Discussion: The paragraph would benefit from revision for clarity and to remove language that could be seen as regulatory.</p> <p>Recommended changes: When the four-year inspection interval was missed, B18255 operated with an outstanding CPCP inspection, from November 30, 1997 to December 28, 1998, which would be considered a safety deficiency. Subsequently, missed CPCP inspections for other parts of the aircraft began to accumulate. The aircraft was operated with outstanding CPCP inspections from most of the period from November 30, 1997 to the date of the accident. These outstanding CPCP inspections were a safety deficiency but were unrelated to the accident.</p>
50	<p>Page 238</p> <p>Section 2.9.6 (5<sup>th</sup> paragraph): The Safety Council concludes that the current CAA oversight system of operator's maintenance programs was not adequate to detect the hidden deficiency, such as the CAL CPCP inspection scheduling, in the maintenance program. The Safety Council believes that CAA should establish a periodical maintenance records inspection procedure at appropriate intervals to ensure that all work required to maintain the continuing airworthiness of an aircraft has been carried out. In particular, the inspection procedure should verify whether all the maintenance specified in the maintenance program for the aircraft has been completed within the time periods (flight hours, cycles, and calendar years) specified. The Safety Council also believes that CAA should encourage the operators to establish a maintenance record keeping system that would provide a clearer view for the inspector/auditor for records review.</p>	<p>Issues/Discussion: This section could also be made clearer and more balanced with wording that does not imply blame.</p> <p>The carrier is responsible for establishing effective maintenance programs and schedules. The regulator's oversight should be sufficient to provide assurance that the carrier's systems are working. The oversight will be provided through audits and inspections that sample enough documents and check enough of those documents against the carrier's aircraft to provide assurance that the system is operating as intended. The audits and inspections will not, and cannot be expected to, catch every error and deficiency.</p> <p>Recommended changes: The CAA's oversight of the operator's system of inspection and maintenance did not detect the deficiency in the scheduling of CPCP inspections over several years. The records were inadvertently designed in a way that did not expose the deficiency easily to either the CAA or the carrier. The CAA has mandated operators to review and revise, as necessary, maintenance record keeping procedures to assure compliance with pertinent regulations. This means that records will be required to provide a clearer view of what is required and what is done. The CAA has also increased its oversight activities.</p>

<b>No.</b>	<b>Original</b>	<b>Recommended Change</b>
51	<p>Page: 239</p> <p>Section: 2.9.7: In the paragraph at the top of page 239 there is the statement that "It is apparent that the damage tolerance philosophy did not ensure the aircraft structural integrity in this case."</p>	<p>Issues:</p> <p>(1) This section includes an extensive discussion regarding Widespread Fatigue Damage (WFD) and Multi-Site Damage (MSD). These discussions, while substantially correct, do not appear to add to the purpose of the ASC Report.</p> <p>(2) The damage tolerance philosophy is of rather recent origin. Were the original structure and the Structural Repair Manual design based upon damage tolerance principles?</p> <p>Recommended change:</p> <p>(1) Consider deleting material that is not central to the objectives of the Report. Safety promotion can be accomplished more effectively using other methods.</p> <p>(2) Consider modifying the statement concerning the failure of the damage tolerance philosophy in this accident case.</p>
52	<p>Page: 241</p> <p>Section: 2.9.8</p>	<p>Issues:</p> <p>The last two paragraphs of this section appear to be interesting and informative, but not essential to the purpose of the Report.</p> <p>Recommended change:</p> <p>Consider deleting this material, or revising it to make it more directly relevant to the Report.</p>

## SECTION 3 CONCLUSIONS

No.	Original	Recommended Change
53	Conclusions, General: Many individuals will read the conclusions without reading the balance of the report.	Recommended Change: It would assist readers in understanding the report if you were to write out the abbreviated items in full, except where the meaning is clear. Similarly, it would be easier to use the references if the numbers in parenthesis showed at least three digits for all findings.
54	Page: 244 - 251  Section: 3.1 to 3.3 Conclusions	Issues:  Many of the Conclusions should be carefully reviewed to ensure that they are, in fact, substantiated conclusions.  Recommended change:  Review all findings, especially those that relate to the CVR record. It is not clear that findings 11 and 12 of Sec. 3.3 (Other Findings) can be substantiated. Therefore, they should be deleted.
55	Page: 243 Para 1  Section 3 Conclusions: In this Chapter, the Safety Council presents the findings derived from the factual information gathered during the investigation and the analysis of the CI611 accident. Because a large portion of fuselage section 46 wreckage was not found, the Safety Council cannot draw a definitive conclusion. However, based on all the evidence and analysis, the Safety Council believes that the breakup was highly likely due to a structural failure in the aft lower lobe section of the accident aircraft.	Issues: There is a conflict between the first paragraph of the conclusions and finding 3. The first paragraph states that because a large portion of fuselage section 46, wreckage was not found, the Safety Council cannot draw a definitive conclusion and the break-up was 'highly likely' due to a structural failure. Finding 3 that says the break-up was due to 'a structural failure, without qualification.  Discussion: The two statements should be brought into agreement.  Recommended change: In this Chapter, the Safety Council presents the findings derived from the factual information gathered during the investigation and the analysis of the CI611 accident. A large portion of fuselage section 46, wreckage was not found, but the Safety Council, based on all the available information and analysis, believes that the break-up was "highly likely due to a structural failure in the aft lower lobe section of the accident aircraft."  Take either the above wording or change finding 3 to bring doubt into that conclusion statement as well. It appears that the statement with some doubt is more appropriate. Also, minor editorial changes have been proposed for improved clarity.

<b>No.</b>	<b>Original</b>	<b>Recommended Change</b>
56	<p>Page 244</p> <p>Section 3.1 Findings Related to</p> <p>Probable Causes: Section 3.1, Conclusion 2: The permanent repair was not accomplished in accordance with the Boeing SRM. That is, the damaged skin in Section 46 was not removed and the repair doubler did not cover the entire damaged area after the removal of the damage skin, as evidenced by scratches found on the skin inside and outside the repair doubler. (1.6, 1.16, 2.2.)</p>	<p>Issue/Discussion: The latter part of the statement is not clear. Questions for the ASC remain – Why was the SRM not followed? Why didn't the Boeing representative intervene? Was a doubler, at the time, considered an adequate repair?</p> <p>Recommended changes: CAL recorded the permanent repair as being accomplished in accordance with the Boeing SRM. However, a post-accident review strongly suggests that the record reflects a misinterpretation of the repair requirements. That is, the damaged skin in Section 46 was not replaced. A repair doubler was used, but it did not effectively cover the entire damaged area, as is shown by scratches on the skin outside the outer row of rivets on the repair doubler, and the scratched area was too large to be repaired with a doubler. (1.6, 1.16, 2.2.) In addition, if possible, answer the questions posed in the issues above.</p>
57	<p>Page 244:</p> <p>Section 3.1, Conclusion 3: Based on the recordings of the CVR and FDR, radar data, the dado panel open-close positions and the wreckage distribution, the in-flight breakup of CI611, as it approached its cruising altitude, was due to the structural failure in the aft lower lobe section of the fuselage. (1.8, 1.11, 1.12, 2.1, 2.6, 2.7, 2.8)</p>	<p>Issue/Discussion: Rather than citing specific elements of the investigation, some of which are debatable, the finding can be strengthened by referring to the entire investigation. Also, the doubt that was expressed by the Council should be reflected in the conclusion.</p> <p>Recommended changes: Based on the facts and analysis in this report, the in-flight break-up of CI611, as it approached its cruising altitude, was highly likely due to the structural failure in the aft lower lobe section of the fuselage. (1.8, 1.11, 1.12, 2.1, 2.6, 2.7, 2.8)</p>
58	<p>Page 244:</p> <p>Section 3.1, Conclusion 4: At 1527:49, 10 seconds before the FDR stopped, the FDR parameters of vertical acceleration showed change that may have been indications of vibrations or other forces as the aft lower lobe structure began to fail. (1.11, 2.1)</p>	<p>Issue/Discussion: A statement that necessarily contains the words 'may have been' is conjectural and should not be considered as a finding.</p> <p>Recommended changes: Delete finding 4 related to probable causes.</p>



<b>No.</b>	<b>Original</b>	<b>Recommended Change</b>
59	<p>Page 244</p> <p>Section 3.1, Conclusion 5: Evidence of fatigue damage was found in the lower aft fuselage centered about STA 2100, between stringers S-48L and S-49L along the edge of the repair doubler. A cumulative length of 25.4 inches of multiple-site fatigue damage (MSD), including a 15.1-inch continuous through thickness crack and other small fatigue cracks were confirmed. Most of them were initiated from the scratching damage caused by the 1980 tail-strike incident. (1.16.3, 2.2)</p>	<p>Issues/Discussion: Fatigue damage was clearly found and minor wording changes would make the finding clearer.</p> <p>Recommended changes: Fatigue damage was found in the lower aft fuselage centered about STA 2100, between stringers S-48L and S-49L, under the repair doubler but near its edge and outside its outer row of securing rivets. A cumulative length of 25.4 inches of multiple-site fatigue damage (MSD), including a 15.1-inch continuous through thickness crack and some small fatigue cracks were confirmed. Most of them were initiated from the scratches associated with the 1980 tail-strike incident. (1.16.3, 2.2)</p>
60	<p>Page 244</p> <p>Section 3.1, Conclusion 6: Based on the residual strength analysis, the MSD cracking was sufficient to cause the local linking of the cracks within a two-bay region (40 inches), which is also supported by the metallurgical examination. The cracking then kept growing and extended gradually forward and aft in a slow and ductile way. An overall pre-existing cracking of at least 71 inches was identified by evidence of the extent of fretting marks on the overhanging edge of the repair doubler. (2.3)</p>	<p>Issues/Discussion: There were factors in addition to Multiple Site Damage that encouraged crack growth. For example, the hoop stresses in the hull that were associated with aircraft pressurization cycles. Some small language changes would also make the finding clearer.</p> <p>Recommended changes: Based on the residual strength analysis, the Multiple Site Damage cracking was sufficient to facilitate the linking of the cracks within a two-bay region (40 inches). This is supported by the metallurgical examination. The slow, ductile cracking kept growing and extended gradually forward and aft. The estimate of overall pre-accident cracking of from -- to -- inches was based on the extent of the fretting marks on the edge of the repair doubler. (2.3)</p>
61	<p>Page 245</p> <p>Section 3.1, Conclusion 7: Residual strength analysis and frame capability analysis indicated that the skin assembly and STA 2100 frame were both beyond their capability limits with the extent of identified damage during the application of normal operational loads. (2.3)</p>	<p>Issues/Discussion: The finding is difficult to follow and would benefit from rewording for clarity.</p> <p>Recommended changes: The results of the calculations used in the residual strength analysis and frame capability analysis show that, with the observed damage, normal operating loads would take the skin assembly and the station 2100 frame beyond their load-bearing limits.</p>

<b>No.</b>	<b>Original</b>	<b>Recommended Change</b>
62	<p>Page 245</p> <p>Section 3.1, Conclusion 8: Maintenance inspection of B18255 for the past 22 years failed to detect the improper 1980 structural repair and the fatigue cracking underneath the repair doubler. However, the time that the fatigue cracks propagated through the skin thickness could not be determined. (1.6.3, 2.2, 2.9)</p>	<p>Issues/Discussion: Reword the finding to replace the blaming language with more accurate descriptive wording for balance and clarity.</p> <p>Recommended change: Maintenance inspections of the accident aircraft over the past 22 years did not detect the ineffective 1980 structural repair and the fatigue cracking that was developing under the repair doubler outside the outer row of rivets. The aircraft was operated in accordance with the Approved Maintenance Program that was developed through Boeing's Maintenance Planning Data. The investigation could not determine when the fatigue cracks propagated through the skin. (1.6.3, 2.2, 2.9)</p>
63	<p>Page 245</p> <p>Section 3.1, Conclusion 9: Corrosions was found on portions of item 640 skin, some of which penetrated the thickness of the skin that did not exhibit a pattern of salt-water induced corrosion. The corrosion would reduce the residual strength of the skin. However, since a major portion of the fuselage adjacent to item 640 was not recovered, the extent of the reduction in residual strength could not be determined. (1.16.3, 2.3)</p>	<p>Issues: This finding is inconsistent with the earlier draft that stated in original finding 49 that "the Safety Council believes that the corrosion bears no relation with this accident."</p> <p>Discussion: There is little in the factual or analytical information in the report about a "reduction in residual strength" (associated with corrosion) other than a short statement that says that its effect could not be determined. In fact, as the through thickness corrosion was covered by the doubler, there was no compromise in the strength of the aircraft associated with the identified corrosion. This needs to be made plain to understand the accident.</p> <p>Recommended change: Delete the finding. If a finding about corrosion were to be included in some form it should be moved to 'Findings Related to Risk'.</p>

No.	Original	Recommended Change
64	<p>Page 246</p> <p>Section 3.2 Findings Related to Risk</p> <p>Finding 1, 2 &amp; 3:</p> <p>Finding 1: CAL performed the first CPCP inspection of B18255 in November 1993. The inspection interval for CPCP inspection item 53-125-01, the lower lobe of the fuselage, was 4 years; therefore, the second CPCP inspection for item 53-125-01 should have been in November 1997. CAL scheduled the second CPCP inspection of item 53-125-01 in the following MPV check in December 1998, 13 months later than the required 4-year inspection interval. Neither CAL nor CAA was aware that inspection implementation had been delayed until one-and-half years after the accident. (1.6, 2.9)</p> <p>Finding 2: According to maintenance records, starting from November 1997, B18255 had a total of 29 CPCP inspection items that were not accomplished in accordance with the CAL AMP and the Boeing 747 Aging Airplane Corrosion Prevention &amp; Control Program. The aircraft had been operated with unresolved airworthiness safety deficiencies from November 1997 onward. (1.6, 2.9)</p> <p>Finding 3: Inadequate management oversight, miss-communication between the MOC and MPS sections, a computer control system that did not control the maintenance schedule by calendar year, and an ineffective self-auditing system of maintenance scheduling, led to the CPCP inspection being overdue. (1.6, 2.9)</p>	<p>Discussion: Based on the number of Findings Related to Risk that are in the report, the reader may reasonably draw the invalid inference that the missed CPCP inspections were material to the accident. The missed dates for inspections do introduce an element of risk that needs to be addressed, but not to the point where it diverts the attention of readers from questions about metal fatigue. Findings 1, 2 &amp; 3 can be combined to provide better balance to the report without compromising the message being sent by the ASC.</p> <p>The group of findings could also be made clearer and more balanced with wording that does not imply blame. They would also be clearer if they addressed the underlying problem rather than showing a tally of overdue inspections.</p> <p>The information in the three findings is correct but not quite complete and would benefit from clarification. The Maintenance Planning Data could have been amended to define a procedure for restarting the CPCP cycle if an inspection was missed. Corrosion is primarily time dependent and the key point is that the validity period is to be four years after the last inspection. The accident occurred less than four years after the last CPCP inspection.</p> <p>Recommended Changes: <i>Combine the three findings to read:</i> CAL's first CPCP inspection of the accident aircraft was in November 1993 making the second CPCP inspection of the lower lobe fuselage due in November 1997. CAL inspected that area 13 months later than the required four-year interval. The accident occurred within four years of the most recent CPCP inspection. When the CPCP scheduling went off track, the corrosion inspections did not occur in accordance with the CAL AMP and the Boeing 747 Aging Airplane CPCP, which introduced a level of risk. The corrosion inspections were scheduled to coincide with inspections based on flight hours. Reduced aircraft utilization led to the dates of the flight hour inspections being postponed, thus the corresponding CPCP inspection dates were passed. CAL's oversight and surveillance programs did not identify the missed inspections. Corrosion, which is what the CPCP is designed to identify was not a factor in the accident.</p>

<b>No.</b>	<b>Original</b>	<b>Recommended Change</b>
65	<p>Page 246</p> <p>Section 3.2, Finding 4: Because the CPCP inspection item 53-125-01 was required to have been accomplished in November 1997, and was delayed for 13 months, an additional opportunity for a bilge CPCP inspection, which would have been scheduled for November 2001, was missed. (1.6, 2.9)</p>	<p>Issues/Discussion: As written, the finding could be misleading as it seems to infer that a purpose of the CPCP inspection was to identify fatigue cracking. The finding is fairly speculative and thought should be given to deleting it.</p> <p>Recommended changes: A corrosion inspection in the bilge area, although not intended to identify fatigue cracking, may have identified the fatigue cracking as a by-product if it had occurred on the original schedule. However, the time from the last CPCP inspection was not in excess of the four year standard. (As an alternative consider deleting the finding.)</p>

No.	Original	Recommended Change
66	<p>Page 246</p> <p>Section 3.2 Finding 5: The schedule delay of the B18255 CPCP inspection after November 1977 and the deficiency in the CAL maintenance system was not discovered during CAA's oversight and surveillance of the CAL maintenance programs for more than six years.</p> <p>Page 246</p> <p>Section 3.2 Finding 6: The current CAA oversight system of assessing operator's maintenance programs is not adequate to detect hidden deficiencies, such as the CAL CPCP inspection scheduling, in the maintenance program. (1.6, 1.18, 2.9)</p>	<p>Discussion: As previously noted, based on the number of Findings Related to Risk that are in the report, the reader may reasonably draw the invalid inference that the missed CPCP inspections were material to the accident. The missed dates for inspections do introduce an element of risk that needs to be addressed, but not to the point where it diverts the attention of readers from questions about metal fatigue. Findings 5 &amp; 6 can be combined to provide better balance to the report without compromising the message being sent by the ASC.</p> <p>The group of findings could also be made clearer and more balanced with wording that does not imply blame. An audit system is designed to ensure that an operator has an adequate system of oversight and controls. In itself, the audit system is not designed to catch every deviation from standards. The audit is to see whether the carrier has adequate oversight and control procedures. The finding can be made more accurate by recognizing the limitations of an audit. It is also useful to concentrate on the tail-strike repair rather than the CPCP inspections.</p> <p>The last CPCP should have been accomplished on November 30 of 1997, This inspection was not performed until December 28, 1998, 13 months overdue. The due date of the next CPCP would have been on or before December 28, 2002. The date of the accident was May 25, 2002,</p> <p>Recommended changes: The scheduling problem with the China Air Lines maintenance inspection practices was not identified by CAA audits. While any audit might miss some deficiencies, the audit system would be expected to identify the deficiencies in scheduling and the ineffective tail-strike repair in the course of several years and several audits.</p>

<b>No.</b>	<b>Original</b>	<b>Recommended Change</b>
67	<p>Page 246/7</p> <p>Section 3.2, Finding 7: From the examination of the repaired doublers of sections 46 and 48, scratch marks were found not removed and nearly 70% of the rivets were either overdriven or under driven, indicating lack of adequate workmanship during the repair process and the follow-up inspections. (1.6, 2.9)</p>	<p>Issues/Discussion: The finding would benefit from editing to make its meaning clearer. As the safety investigation report is to avoid blame and liability, it would be helpful to drop the blaming remark on workmanship and simply note the condition of the rivets. To make plain to readers that this did not have any effect on the accident you may wish to move this to other findings.</p> <p>Recommended changes: Scratch marks were found beneath the repair doublers. In accordance with a 2001 standard, nearly 70% of the doubler rivets were either over-driven or under-driven. The standard at the time the work was done is not known. There is no indication that the riveting job was ineffective.</p>
68	<p>Page 247</p> <p>Section 3.2, Finding 8: Before the accident, CAA had not given formal consideration to monitor the introduction of the repair assessment program (RAP). (1.17,1.18,2.9)</p>	<p>Issues/Discussion: The finding is not valid. The CAA regulations require the operator to comply with the Original Equipment Manufacturer's airworthiness requirements. CAL had incorporated the Repair Assessment Program (RAP) into its maintenance operations. The CAA approved the RAP.</p> <p>Recommended changes: Please delete the finding.</p>
69	<p>Page 247</p> <p>Section 3.2, Finding 9: During the 1998 MPV, inspector's inspection period was shorter than the standard hour allocated, although older aircraft needed more than the standard hours to carry out the inspection tasks. For B18255 aircraft, which was an aged aircraft, to perform a structural inspection would require more time for a detailed inspection to find hidden defects in the structure. (1.6,2.9)</p>	<p>Issues/Discussion: Standard times are developed for inspection tasks. Deviations from the standard may occur when the aircraft is particularly clean or dirty, but there are no variations built into the time standard based on the age of the aircraft. The finding is an opinion as the investigators could not know the state of the aircraft at its Mid Period Visit inspection.</p> <p>Recommended changes: Delete the finding.</p>
70	<p>Page 247</p> <p>Section 3.2, Finding 10: The bilge area was not cleaned in accordance with the CIC cleaning task before the 1st inspection in 1998 MPV. For safety purpose, the bilge area should be cleaned before inspection to ensure a closer examination of the area. (1.6,2.9)</p>	<p>Issues/discussion: As the cleaning task was discretionary and the inspector found 17 defects in the area, there is little basis for criticizing the inspector for not cleaning the area before the inspection. We cannot know whether the area needed cleaning, but the number of deficiencies found suggests that it did not.</p> <p>Recommended changes: Delete the finding.</p>

No.	Original	Recommended Change
71	<p>Page 247</p> <p>Section 3.2, Finding 11: There is no lighting standard for CAL during a structural inspection. An insufficient lighting environment will affect the safety at the work place and inspection results. The PPC (Production Planning Control) section should plan the lighting environment for the detailed structural inspection beforehand, and should set up a SOP to ensure a sufficient lighting environment when structural inspections are performed. (1.6,2.9)</p>	<p>Issues/Discussion: The finding is a combination of a finding and a recommendation.</p> <p>Recommended changes: Keep the first sentence of the finding and move the balance to a recommendation.</p>
72	<p>Page 247</p> <p>Section 3.2, Finding 12: The CAL inspector performed the structural inspections without a magnifying glass. Using a magnifying glass as a standard tool would improve the effectiveness of the structural inspection. (1.6,2.9)</p>	<p>Issues/Discussion: This, while intuitively valid, is more of an opinion than a finding and the carrier has, following the accident, specified the tools to use.</p> <p>Recommended changes: Consider deleting the finding.</p>
73	<p>Page 247</p> <p>Section 3.2, Finding 13: Various painting tasks were carried out on the irregular skin surface and opening between the skin and a repair doubler without awareness of the possibilities</p> <p>that a hidden damage could be under the doubler. (1.6,2.9)</p>	<p>Issues/Discussion: The meaning of the finding is not clear.</p> <p>Recommended changes: As demonstrated by paint under the doubler, various painting tasks were carried out that included painting an irregular surface where some of the sealant for the doubler had separated. There was not awareness that the missing sealant could be, among other things, an indication of damage that was beneath the doubler.</p>
74	<p>Page 247</p> <p>Section 3.2, Finding 14: The traces found on the aft lower lobe fuselage around STA 2100 of B18255 during the CAL structural patch survey for RAP preparation were a clear indication that on November 2001, there was hidden structural damage beneath the doubler. (1.6, 2.9)</p>	<p>Issues/Discussion: There is no doubt that the traces or stains found on the lower fuselage of the aircraft could be an indication of a serious problem. However, they could also be related to something as simple as a loose rivet or fluids from another source that just happened to stick in that area due to the airflow. The finding should be reworded to make it more accurate.</p> <p>Recommended changes: The traces of staining on the aft lower lobe fuselage around STA 2100 on the accident aircraft during CAL's structural patch survey for the Repair Assessment Program were an indication of a possible problem beneath the doubler. However, the photos taken were to be used later in the Repair Assessment Program and were not intended as a repair record and were not intended for examination for maintenance purposes.</p>

<b>No.</b>	<b>Original</b>	<b>Recommended Change</b>
<b>75</b>	<p>Page 247</p> <p>Section 3.2, Finding 15: CAL did not properly record all maintenance activities in the maintenance records before the accident, and the maintenance records were either incomplete or did not exist. (1.6, 2.9)</p>	<p>Issues/Discussion: The finding as presented is inaccurate and could be misleading. It should be restated more accurately.</p> <p>Recommended changes: CAL did not accurately record some of the maintenance activities before the accident and some required records were incomplete or not found.</p>
<b>76</b>	<p>Page 248</p> <p>Section 3.2, Finding 16: CAL continues to maintain that they would categorize the 1980 tail strike repair as a minor repair. (1.6, 2.2)</p>	<p>Issues/Discussion: The finding is invalid as CAL, under direction from the CAA, does not have the discretion to categorize the tail-strike as a minor repair.</p> <p>Recommended changes: Delete the finding.</p>
<b>77</b>	<p>Section 3.2 Findings Related to Risk</p> <p>There is no finding related to the activities of the Boeing representative.</p>	<p>Issues/Discussion: From what is in the draft Report, there is a clear indication that the Boeing field representative could have played a more active role within his listed mandate.</p> <p>Recommended changes: Add a finding to indicate how the lack of assertiveness by the Boeing representative represents a safety deficiency.</p>
<b>78</b>	<p>Page 249</p> <p>Section 3.3, Other Findings</p> <p>Finding 7: There was in-sufficient information to indicate a pressurization malfunction during this flight. (1.12, 2.5, 2.6, 2.7)</p>	<p>Issues/Discussion: The finding should be rewritten for clarity.</p> <p>Recommended changes: There were some pressurization anomalies recorded on the flight data recorder just before the aircraft broke-up, but there was insufficient information to determine whether there was a pressurization malfunction.</p>
<b>79</b>	<p>Page 249</p> <p>Section 3.3, Finding 10: Except the very last sound spectrum, all other sounds from the CI611 CVR recordings yielded no significant information related to this accident. (1.11, 2.6)</p>	<p>Issues/Discussion: The CVR Explosion Analysis represents some interesting experimental work but many years of development have not yet yielded consistent results. There is no question that it was worth conducting the analysis, but the data on the last sound spectrum must be treated as suspect at best.</p> <p>Recommended changes: Delete the finding.</p>



<b>No.</b>	<b>Original</b>	<b>Recommended Change</b>
<b>80</b>	<p>Page 250</p> <p>Section 3.3 Finding 14: The Ballistic analysis, although with assumptions, confirms that the in-flight breakup of CI611 aircraft initiated from the lower lobe of the aft fuselage. Several conclusions can be drawn from the analysis: (1.11, 2.7)</p> <p>a. Some segments might have broken away more than 4 seconds after power lose of the recorders. Several larger segments might have separated into smaller pieces after the initial breakup.</p> <p>b. The engines most likely separated from the forward body at FL290 about 1528:33.</p> <p>c. Airborne debris (papers and light materials) from the aft fuselage area, departed from the aircraft about 35,000 ft altitude, and then traveled more than 100 km to the central part of Taiwan.</p>	<p>Issues/Discussion: The assumptions in the ballistic analysis are necessarily significant enough to invalidate the word 'confirms' and should be replaced with 'is consistent with'. The conclusions drawn from the analysis are too speculative to be listed. Other minor changes would improve the clarity and readability of the finding.</p> <p>Recommended changes: The Ballistic Analysis, which includes significant assumptions, is consistent with the in-flight break-up of flight CI611 being initiated in the lower lobe of the aft fuselage.</p>
<b>81</b>	<p>Page 250</p> <p>Section 3.3, Finding 16: It was possible that the through-thickness pre-existing fatigue cracking in the underlying skin might have occurred before the sealant was replaced during the 1996 re-paint. This could create an opening to allow the paint to seep into the opening during annual touch up process. (1.6, 1.16, 2.9)</p>	<p>Issues/Discussion: A statement with the terms 'it was possible', 'might have occurred', and 'could create' is clearly conjecture and not a finding.</p> <p>Recommended changes: Delete the finding.</p>
<b>82</b>	<p>Page 251</p> <p>Section 3.3, Finding 17: The determination of the implementation of the maximum flight cycles before the repair assessment program (RAP) was based primarily on fatigue testing of a production aircraft structure (skin, lap joints, etc.) and did not take into account of possible poor workmanship and inadequate follow-up inspections associated with prior structural repairs. (1.6, 1.17, 1.18, 2.9)</p>	<p>Issues/Discussion: The finding points to either a deficiency in the manufacturer's maintenance philosophy or a deficiency in the functions of the company field service representative. It should be reworded and moved to the Risk Related category and consideration should be given to making a recommendation to the manufacturer.</p> <p>Recommended changes: The determination of the maximum number of flight cycles before introducing a repair assessment program (RAP) was based primarily on fatigue testing of a production aircraft (skin, lap joints, etc.) and did not take into account variations in the standards of repair, maintenance, workmanship and follow-up inspections that exist among air carriers.</p>

## SECTION 4 RECOMMENDATIONS

No.	Original	Recommended Change
<b>83</b>	<p>Page 255</p> <p>Section 4.1 Recommendations</p> <p>To CAA, Recommendation 1: Ensure that all safety-related service documentation relevant to ROC registered aircraft are received and assessed for safety of flight implications. The assessment process should ensure that those aspects affecting the safety of flight are implemented or mandated as necessary and that appropriate systems are in place to ensure compliance. (1.6, 1.17, 2.9)</p>	<p>Issues/Discussion: Suggest that it would be very helpful in all cases to put responses right under the recommendations so that readers can see whether the recommendations have been acted upon.</p> <p>Recommended changes: Ensure that all safety-related service documentation relevant to ROC-registered aircraft is received and assessed by the carriers for safety of flight implications. The regulatory authority process should ensure that the carriers are effectively assessing the aspects of service documentation that affect the safety of flight.</p> <p><u>CAA response:</u></p> <ol style="list-style-type: none"> <li>1. All ICAO Annex 8, documents have been received by the CAA and have been reissued and directed to air carriers as CAA mandatory requirements.</li> <li>2. The CAA AOR article 137, paragraph 1, section 2 requires operators to acquire and comply with the manufacturer's continuing airworthiness information.</li> <li>3. The CAA will strengthen its ability to verify that the carriers are effectively assessing service documentation affecting the safety of flight.</li> </ol>

<b>No.</b>	<b>Original</b>	<b>Recommended Change</b>
<b>84</b>	<p>Page 255</p> <p>Section 4.1, Recommendation 2: Consider the introduction of a periodical maintenance records inspection procedure at appropriate intervals to ensure that all work required to maintain the continuing airworthiness of an aircraft has been carried out. In particular, the inspection procedure should verify whether all the maintenance specified in the maintenance program for the aircraft has been completed within the time periods specified. (1.6, 1.17, 2.9)</p>	<p>Issues/Discussion: It is the duty of the carrier, and not the regulator, to conduct all the maintenance necessary for continuing airworthiness of its fleet.</p> <p>Recommended changes: As part of its oversight duties, the CAA should consider reviewing its inspection procedure for maintenance records. This should be done with a view to ensuring that the carriers' systems are adequate and are operating effectively to make certain that the timeliness and completeness of the continuing airworthiness programs for their aircraft are being met.</p> <p>To ensure that the operator's maintenance records system is in compliance with relevant regulations, efficient and complete, the CAA issued Standards letter 2, No. 09300024100 on January 27, 2004. This Standards letter requires each operator to review its own maintenance records system and maintenance records keeping to determine whether it meets the above-mentioned requirements. Moreover, to provide guidance for operators to comply with relevant regulations, the CAA also issued AC43-001A as a reference for operators; CAA inspectors will conduct inspections using the referenced AC.</p>
<b>85</b>	<p>Page 255</p> <p>Section 4.1, Recommendation 3: Encourage operators to establish a mechanism to manage their maintenance record keeping system, in order to provide a clear view for inspector/auditors conducting records reviews. (1.6, 2.9)</p>	<p>Issues/Discussion: The CAA has already acted upon this recommendation.</p> <p>Recommended changes: Either delete the recommendation or note that it has been complied with by repeating the wording from the CAA's recommendation in the preceding recommendation.</p>
<b>86</b>	<p>Page 255</p> <p>Section 4.1, Recommendation 4: Encourage operators to assess and implement safety related airworthiness requirements at the earliest practicable time. (1.6, 2.9)</p>	<p>Issues/Discussion: The CAA evaluates all airworthiness requirements for an appropriate time of compliance before they are issued.</p> <p>Recommended changes: Either delete the recommendation or note that the CAA has complied with the intent of the recommendation.</p>

<b>No.</b>	<b>Original</b>	<b>Recommended Change</b>
<b>87</b>	<p>Page 255</p> <p>Section 4.1, Recommendation 5: Consider the implementation of battery backup for flight recorders and dual combination recorders with one in the cockpit area and one in aft section of the aircraft to improve the effectiveness in flight occurrence investigation. (1.11,2.6)</p>	<p>Issues: The recommendation is beyond the control of the CAA. Taiwan is too small to introduce such a change on its own and being excluded from ICAO it has no influence there. This recommendation is better addressed to the state of manufacture or the manufacturer.</p> <p>Discussion: The recommendation is overly specific. It would be better to recommend an independent power source rather than a battery. A capacitor, for example, might be used instead of a battery. Similarly, the cockpit area may not be the best choice of location from a technical point of view. It could be, for example, a wing tip. The CAA can then monitor changes to the international standard.</p> <p>Recommended changes: Delete this recommendation to the CAA. Amend the wording to make it less specific and address it to the state of manufacture.</p>
<b>88</b>	<p>Page 256</p> <p>Section 4.1, Recommendation 6:</p> <p>1. Consider adding cabin pressure as one of the mandatory FDR parameter. (1.12, 2.5)</p>	<p>Issues/Recommendation: Taiwan is too small a state to implement the change.</p> <p>Recommended changes: Delete this recommendation to the CAA and make it instead to the state of manufacture.</p>
<b>89</b>	<p>Page 256</p> <p>Section 4.1, Recommendation 7:</p> <p>Ensure that the process for determining implementation threshold for mandatory continuing airworthiness information, such as RAP, includes both safety aspects, operational factors, and the uncertainty factors in workmanship and inspection. The information of the analysis used to determine the threshold should be fully documented. (1.18, 2.2, 2.9)</p>	<p>Issues/Recommendation: This is a recommendation that would be most appropriately handled by the state of manufacture or to the aircraft manufacturer, rather than a small operating state like the ROC.</p> <p>Recommended changes: Direct the recommendation to the USA and to Boeing. A recommendation to the CAA to cooperate in implementation of the recommendation would be appropriate.</p>

<b>No.</b>	<b>Original</b>	<b>Recommended Change</b>
<b>90</b>	<p>Page 256</p> <p>Section 4.1, Recommendation 8:</p> <p>Develop or enhance research effort for more effective non-destructive inspection devices and procedure. (1.6, 2.2, 2.3, 2.9)</p>	<p>Issues/Recommendation: Taiwan is not likely to be able to develop appropriate new, internationally-accepted, non-destructive testing methods on its own. Taiwan could cooperate in the development of such methods.</p> <p>Recommended changes: Make the recommendation to the USA and Boeing. A recommendation to the CAA to cooperate or assist in the development of NDT methods associated with detecting small cracks in inaccessible or difficult to inspect areas on aircraft would be appropriate.</p>

No.	Original	Recommended Change
91	<p>PAGE 257,258,259</p> <p>SECTION 4.2 SAFETY ACTION TAKEN OR BEING PLANNED</p> <ol style="list-style-type: none"> <li>1. On Enhancing Management...</li> <li>2. CAA cooperated with Boeing to host...</li> <li>3. CAA and Flight Safety Foundation...</li> <li>4. Participants in the above meetings...</li> <li>5. Notwithstanding the fact that it has...</li> <li>6. On Revision of related...</li> <li>7. Prior to FAA's publication of AD, ...</li> <li>8. By referring to FAR...</li> <li>9. AD 2003-03-020 was issued</li> <li>10. CAA issued "Advisory...</li> <li>11. In view of the...</li> <li>12. AC 43-002 was issued...</li> <li>13. CAA added the section...</li> <li>14. To ensure operator's...</li> <li>15. To ensure the requirements.</li> </ol>	<p>Issues/Recommendation:</p> <p>This section has been revised to include the latest CAA actions</p> <p>Recommended changes:</p> <p>This section has been revised as follows:</p> <p>Item 14. To ensure operator's maintenance of various fleets meet the aircraft maintenance program approved by CAA, CAA issued an administrative order on January 27, 2003 requesting local air operators to conduct a self-audit by comparing their maintenance records with related aircraft maintenance program. The airworthiness inspectors from CAA also conducted an in-depth inspection in conjunction with all operators in mid May and all discrepancies found had been corrected by the end of May 2004.</p> <p>New item: To ensure the operator's maintenance records system is in compliance with relevant regulations, efficient and complete, CAA issued a letter, Standards 2, No.09300024100, on January 27, 2004 requesting each operator to review its own maintenance records system and maintenance records keeping and determine whether it meets the above-mentioned requirements. Moreover, to provide a guidance for operators to comply with relevant regulations, CAA also issued AC 43-001A as a reference for operators; CAA inspectors will conduct inspections using the said AC.</p> <p>Note: Item 1 should be a title A, and item 2,3,4,5,are subtitle of A and should be renumbered as 1,2,3,4.</p> <p>Item 6 should be a title B, and other items should be renumbered as above way.</p>

**CAA of ROC Representations to the ASC on the Final Draft Rev.2  
of the Report on the Investigation of the China Air Lines Boeing  
747-200 Accident on May 25, 2002**

**SECTION 1 FACTUAL INFORMATION**

No.	Original	Recommended Change
1	<p>Page 12</p> <p>Section 1.6.2.2: Paragraph 2</p> <p>It was approved by the FAA on February 22, 2002 and later was mandated by FAA AD 2004-07-22. CAA also issued the same AD as CAA AD 2002-06-011A.. The AD was effective on May 12,2004. For all Model 747 series planes, prior to reaching either of the thresholds specified in the AD, or within 12 months after the effective data of the AD, whichever occurs later, incorporate Boeing Document D6-35022 into an approved maintenance program.</p>	<p>Issues/ Discussion :</p> <p>The development of SSI amendment</p> <p>Recommended changes: <u>The Revision G of document D6-35022</u> was approved by the FAA on February 22, 2002 and later was mandated by <u>CAA AD 2002-06-011</u> on July 18, 2002. <u>Subsequently FAA issued the same AD as FAA AD 2004-07-22</u> on March 24, 2004, <u>which was effective on May 12, 2004. For all Model 747 series planes, prior to reaching either the thresholds specified in the AD or within 12 months after the effective data of the AD, whichever occurs later, the operator must incorporate Boeing Document D6-35022 into an approved maintenance program. Prior to the FAA issuance of the AD2004-07-22, CAL B742 fleet were not listed by the manufacturer as the candidate fleet for SSI.</u></p>
2	<p>Page 28</p> <p>Section 1.6.5: CAL was not able to, and in accordance with CAA regulation it was not required to, provide the aircraft release information and a damage assessment or evaluation report of the specific damage that occurred in 1980 in Hong Kong.</p>	<p>Issues: In accordance with CAA regulation it was not required to...</p> <p>Discussion: Chapter 1 in "Aircraft Maintenance Release Procedure" stipulates clearly that the continued airworthiness release items regarding the maintenance release, personnel qualification, release record keeping and maintenance release procedure on repair, alteration, and fabrication for aircraft, engine, propeller and its system equipment, components should be complete.</p> <p>CAL did not preserve the repair record till two years from the permanent grounding of the aircraft, concerning the occurrence of the tail strike at that time, primarily because of its judgment that the repair was not categorized as a major repair.</p> <p>Recommended changes: CAL was not able to provide a damage assessment or evaluation report of the specific damage that occurred in 1980 in Hong Kong.</p>

## SECTION 2 ANALYSIS

No.	Original	Recommended Change
3	<p>Page 168</p> <p>Section 2.4.3.2 –paragraph 6</p> <p>Interview records indicated that the CAA was aware of the RAP in 2000. However, the CAA stated that because there were only a few aircraft that would fall into the aging aircraft category in Taiwan, the CAA did not take any action to adopt the program into the system immediately. When the CAL proposed its RAP to the CAA, the CAA accepted the program and requested CAL to provide training for their maintenance personnel before RAP implementation. The CAA also requested notification from CAL when the training was going to be conducted.</p>	<p>Issues/Discussion:</p> <ol style="list-style-type: none"> <li>1. Based on the pertinent ICAO SARPs the CAA had implemented its rulemaking in its AOR (Aircraft Operations Regulations) accordingly before the accident.</li> <li>2. In compliance with international aviation practice, CAA already issued Airworthiness Directive to conform to the AD issuance requirement from the manufacture authority.</li> <li>3. It is stipulated in CAA regulations requiring that the operator is in compliance with manufacturer airworthiness requirements for the continued airworthiness standards of aircraft.</li> <li>4. In the light of the above CAA requirement, CAL sent engineers to attend Boeing RAP training and incorporated RAP into its maintenance program.</li> </ol> <p>Delete the lower half of this paragraph and change as followed:</p> <p>Interview records indicated that the CAA was aware of the RAP in 2000. However, the CAA stated that because there were only a few aircraft that would fall into the aging aircraft category in ROC. Nevertheless CAA regulations require that the operator should be in compliance with manufacturer airworthiness requirements for the continued airworthiness standards of aircraft. In the light of the above CAA requirement, CAL sent engineers to attend Boeing RAP training and incorporated RAP into its maintenance program .</p>



No.	Original	Recommended Change
4	<p>Page 168-169</p> <p>Section 2.4.3.2 –paragraph 7</p> <p>Since CAA did not issue any form of documentation to request operators to adopt the RAP, the RAP was not a mandatory program in Taiwan before the accident. Nevertheless, CAL decided to incorporate the program into its maintenance program based on the CAL’s own assessment. Although CAA stated that before the accident, ROC’s registry did not list any aging aircraft other than CAL’s five B747-200s, thus, there were no other aging aircraft operators to notify, and CAL had initiated the RAP within the timeframe specified in the FAA amended rules. The Safety Council believes that the CAA should take proactive approach to monitor the introduction of any continuing airworthiness information, such as the RAP, and consider adopting the information directly or taking appropriate action.</p>	<p>Issues/Discussion:</p> <p>Same as above.</p> <p>Recommended changes:</p> <p>Delete this whole paragraph</p>
5	<p>Page 173</p> <p>Section 2.4.5 – 3rd. paragraph</p> <p>The PMI stated that, if the B-18255 CPCP inspection record had been reviewed and he had been back traced the inspection interval for each inspection item; he might have been able to find the CPCP overdue problem. However, CAL did not have separate CPCP inspection records. The CPCP records were mixed within the B-18255 maintenance records. With this procedure, it would be difficult to trace the CPCP inspection intervals during the maintenance records inspection.</p>	<p>Issues/Discussion:</p> <p>The statement made during the interview is also viewed as a reaction of personal feeling to a certain degree. It is therefore believed that several responses to the presumptive questions are not realistically credible in an objective situation.</p> <p>Recommended changes: <u>The PMI did not specifically review the CPCP records in 2001, because CPCP program was already incorporated into Aircraft Maintenance Program in according with AD requirement,</u> Therefore CAL did not have a separate CPCP inspection record filed. The CPCP records were mixed within the B-18255 maintenance records. With this procedure, it would be difficult to trace the CPCP inspection intervals during the maintenance records inspection.</p>

## SECTION 3 CONCLUSIONS

No.	Original	Recommended Change
6	<p>Page 221:</p> <p>Section 3.1, Conclusion 4: Evidence of fatigue damage was found in the lower aft fuselage centered about STA 2100, between stringers S-48L and S-49L, under the repair doubler near its edge and outside the outer row of securing rivets. A cumulative length of 25.4 inches of fatigue cracks, including a 15.1-inch continuous through thickness crack and some small fatigue cracks (MSD) were confirmed. Most of them were initiated <u>form</u> the scratching damage associated with the 1980 tail strike incident. (1.16, 2.2)</p>	<p>Issues:</p> <p>Typing error</p> <p>Recommended change: Evidence of fatigue damage was found in the lower aft fuselage centered about STA 2100, between stringers S-48L and S-49L, under the repair doubler near its edge and outside the outer row of securing rivets. A cumulative length of 25.4 inches of fatigue cracks, including a 15.1-inch continuous through thickness crack and some small fatigue cracks (MSD) were confirmed. Most of them were initiated <u>from</u> the scratching damage associated with the 1980 tail strike incident. (1.16, 2.2)</p>
7	<p>Page: 223</p> <p>Section: 3.2 Conclusions 2 : According to maintenance records, starting from November 1997, B-18255 had a total of 29 CPCP inspection items that were not accomplished in accordance with the CAL AMP and the Boeing 747 Aging Airplane Corrosion Prevention &amp; Control Program. The aircraft had been operated with unresolved safety deficiencies from November 1997 onward. Neither CAL nor CAA was aware that inspection implementation had been delayed until one-and-half years after the accident. (1.6, 2.4)</p>	<p>Issues/ Discussion:</p> <p>Annexing Section: 3.2 conclusion 3 into conclusion 2, shall meet the professional depth of the investigation report.</p> <p>Recommended change:</p> <p>According to maintenance records, starting from November 1997, B-18255 had a total of 29 CPCP inspection items that were not accomplished in accordance with the CAL AMP and the Boeing 747 Aging Airplane Corrosion Prevention &amp; Control Program. The aircraft had been operated with unresolved safety deficiencies from November 1997 onward. Neither CAL nor CAA was aware <u>of the scheduling deficiencies in the CAL CPCP maintenance inspection for that specific aircraft. And that</u> inspection implementation had been delayed until one-and-half years after the accident. (1.6, 2.4)</p>
8	<p>Page: 223</p> <p>Section 2 Conclusions 3: The scheduling deficiencies in the CAL maintenance inspection practices were not identified by the CAA audits.</p>	<p>Issues/ Discussion:</p> <p>Annexing Section: 3.2 conclusion 3 into conclusion 2 is seen as an avoidance of restatement.</p> <p>Recommended change: Delete this item</p>

No.	Original	Recommended Change
9	<p>Page: 223</p> <p>Section 2 Conclusions 4:</p> <p>Before the accident, CAA had not taken proactive approach to monitor the introduction of the Repair Assessment Program, RAP. (1.17,1.18,2.4)</p>	<p>Issues: CAA had not taken proactive action to incorporate RAP into CAA regulations.</p> <p>Discussion:</p> <ol style="list-style-type: none"> <li>1. Based on the pertinent ICAO SARPs the CAA had implemented its rulemaking in its AOR (Aircraft Operations Regulations) accordingly before the accident.</li> <li>2. In compliance with international aviation practice, CAA already issued Airworthiness Directive to conform to the AD issuance requirement from the manufacture authority.</li> <li>3. It is stipulated in CAA regulations requiring that the operator is in compliance with manufacturer airworthiness requirements for the continued airworthiness standards of aircraft.</li> <li>4. In light of the above CAA requirement, CAL sent engineers to attend Boeing RAP training and incorporated RAP into its maintenance program .</li> </ol> <p>Recommended change: Delete this item</p>

- END -